

FOR MORE JOIN ~ MISSION SSC / BANKING / UPSC



FOR MORE JOIN ~ MISSION SSC / BANKING / UPSC

15 **PRATICE SETS FOR**
RRRB
NTPC (Graduate)
STAGE II EXAM

FOR MORE JOIN ~ MISSION SSC / BANKING / UPSC

- ☞ Arithmetic
- ☞ General Intelligence
& Reasoning
- ☞ General Awareness

FOR MORE JOIN ~ MISSION SSC / BANKING / UPSC

- **Head Office** : B-32, Shivalik Main Road, Malviya Nagar, New Delhi-110017
- **Sales Office** : B-48, Shivalik Main Road, Malviya Nagar, New Delhi-110017
Tel. : 011-26691021 / 26691713

Typeset by Disha DTP Team



DISHA PUBLICATION

ALL RIGHTS RESERVED

© Copyright Publisher

No part of this publication may be reproduced in any form without prior permission of the publisher. The author and the publisher do not take any legal responsibility for any errors or misrepresentations that might have crept in. We have tried and made our best efforts to provide accurate up-to-date information in this book.

For further information about the books from DISHA,
Log on to www.dishapublication.com or email to info@dishapublication.com

FOR MORE JOIN ~ MISSION SSC / BANKING / UPSC

CONTENTS

Indian Railways SWOT Analysis	CA-1-6
Indian Railways Budget Analysis 2016-17	CA-7-8
1. Practice Set-1 with solutions	1-14
2. Practice Set-2 with solutions	15-30
3. Practice Set-3 with solutions	31-46
4. Practice Set-4 with solutions	47-62
5. Practice Set-5 with solutions	63-79
6. Practice Set-6 with solutions	80-94
7. Practice Set-7 with solutions	95-112
8. Practice Set-8 with solutions	113-128
9. Practice Set-9 with solutions	129-145
10. Practice Set-10 with solutions	146-160
11. Practice Set-11 with solutions	161-175
12. Practice Set-12 with solutions	176-190
13. Practice Set-13 with solutions	191-204
14. Practice Set-14 with solutions	205-220
15. Practice Set-15 with solutions	221-236

FOR MORE JOIN ~ MISSION SSC / BANKING / UPSC

FOR MORE JOIN ~ MISSION SSC / BANKING / UPSC



INDIAN RAILWAYS SWOT ANALYSIS



INTRODUCTION

- It is the state owned railway company of India, overseen by the Ministry of Railways.
- The first time a rail locomotive was used in India on 21st Dec. 1851 over Ganga Canal near Town Rurki.
- First train in India ran between Bori Bunder, Bombay to Thane on Saturday 16th April 1853, with 14 carriages / coaches and 400 guests and journey of 33.81 kms taking 1:15 hrs. It was the first commercial passenger service.
- By 1947, there were 42 rail system or railway companies.
- The Great Indian Peninsula Railway was the first railway company of India.
- The first train was hauled by three engines - Sindh, Sahib and Sultan, the Steam Locomotives.
- The Great Indian Peninsula Railway took a set of 8 locomotives from Vulcan Foundry, England in the beginning of operation in India.
- In December 1851, first steam engine Thomason was operated in Roorkee, second was named after Bombay Governor as Lord Falkland, and third was used as trial run of the passenger train in Nov. 1852.
- On August 15, 1854, the first passenger train in eastern section ran between Howrah to Hooghly (24 miles).
- On March 3, 1859, North India got its first passenger train ran between Allahabad and Kanpur (180 Kms).
- In 1895, India started manufacturing its own locomotives.
- In September 1921, Acworth Committee headed by William Acworth decided to separate railway finances from general finances. In 1904, the idea to electrify the rail network was proposed.
- In 1925, India's first ever railway budget was presented.
- The first electric train on Feb 3, 1925 ran on Mumbai Victoria Terminus (VT) - Kurla branch line, a distance of 16 kms.
- In 1951, these 42 companies were nationalised as one unit.
- On April 14, 1951, Southern Railway was formed.
- On April 14, 1952, Northern Railway was formed.
- In 1970, the last steam Locomotive was rolled out of Chittaranjan Locomotive works. By 1985, steam Locomotives were phased out.
- The third class in the Indian Railway was abolished in 1974.
- Railway Fund to assist victims of railway accidents was set up in 1974.
- In 1977, India got its first Railway Museum spreading over 10 acres in New Delhi.
- On March 31, 1978, Railways were split into 9 zones.
- On October 24, 1984, Kolkata became the first Indian city where first metro rail ran 25 kms from Calcutta to Dumdum.
- In 1985, steam locomotives were replaced by diesel and electric locomotives.

- In 1987, computerization of reservation was first carried out in Bombay.
- In 1989, Indian train numbers were standardised to 4 digits.
- On 24 march 1994, first live telecast of railway budget took place.
- In 1995, entire railway reservation was computerised through the railways internet.
- In 1998 Konkan railway was opened for public.
- In 1999, Fairy Queen bagged the National Tourism Award for most innovative and unique Tourism Venture.
- In 2000, Mamta Banerjee became the first woman Railway Minister of India.
- On December 24, 2002, Delhi Metro Rail Corporation (DMRC) began its operation in Delhi.
- Six times Rail Budgets were presented by the Railway Minister Lalu Prasad Yadav from 2004 to 2009.
- On Monday, February 1, 2010 Wi-Fi facility was first launched at Mysore Railway station.
- On October 20, 2011, Bengaluru got Namma Metro.
- On June 8, 2014, Mumbai got Mumbai Metro and Mumbai Monorail.
- The largest platform in India is Kharagpur (W.B.), i.e. 2733 feet long.
- The longest railway tunnel is Konkan (Maharashtra), i.e. 65 km.
- The longest rail bridge is across Godavari river i.e. 10052 feet long.
- Chenab Railway Bridge Kalra (J&K) 359 metres/1177 feet will be world's highest bridge by Dec. 2016. It will surpass current tallest over Beipanjiang river in China (i.e. 275 meters high).
- The largest marshalling yard is at Mughal Sarai.
- Seven classes are at present: (1) AC-1T, (2) AC-2T, (3) AC-3T, (4) Sleeper, (5) AC chair car, (6) First class and (7) Second class.

FOR MORE JOIN ~ MISSION SSC / BANKING / UPSC

SWOT ANALYSIS

Indian Railways

Strengths	Weaknesses
<ul style="list-style-type: none"> • Indian railways is the lifeline of the nation. • Indian railways has largest land property in the country. • It is the largest employer in India followed by Defence. • 13.36 Lakh gazetted and non-gazetted workers are currently employed. • Its production units produce complete range of products in its area of operation, i.e., DG sets, loco components and sub-assemblies. • Indian railroad network (66,030 kms) is the largest in Asia and 4th largest in the world followed by China(3rd), Russia (2nd), USA (1st) and Canada (5th). • It is the world's second largest under one management. • It has taken steps to conduct all examinations online as a measure against malpractices. • It permits Railway Recruitment Board (RRB) candidates to keep the question booklets. • It permitted RRB candidates to upload answer keys and cut-off marks in 2014-15. • In 2014-15, it conducted examinations for 48, 822 vacancies in 284 categories. • It has its own Indian Railways Institute of Civil Engineering Forum to study its various projects and its execution. • Total locomotives are 10822 (Steam 43 + Diesel 5714 + Elec. 5065) in which broad gauge 10391 + Metre gauge 233 in the year 2014-15. • Total passenger coaches are 67308 (EMU 8475 + Conventional 51833 + Others 7000) with a capacity of 1920768 accomodation in 2014-15. • Total freight cars/ wagons are 2,54,006 (Broad gauge 250,711 + Metre gauge 3,139 + Others) • Total tracks are 108706 kms (BG-86,526 kms + MG-18,529 kms + NG-3651 kms) • Total Routes are 66,030 kms (BG 58825 km + MG 4908 km + NG 2297 km) 2014-15. • Total double/multiple tracks are 20,633 kms i.e., 31.25% of total Route kms (2014-2015) • Total Route electrified are 22,224 kms out of total 66,030 kms (i.e., 33.66% of total), 2014-15. • Now it carries over 1.30 crores passengers & 13 lakh tones of freight every day. • It runs about 20,038 trains daily (passenger -12,617 (freight-7421) • It has most powerful locomotive, i.e. Electric Locomotive WAG-9/ WAP-7 (Modified version) capable of hauling 24 coaches at a speed of 140 to 160 km/hour. 	<ul style="list-style-type: none"> • Indian Railways Passenger sector is loss making, i.e. among the lowest of passenger fare in the world. • Accidents and delays cause a dent to the image. • Facilities not comparable to international standards. • Unorganised railway stations, i.e. dirty and poor in infrastructure. • Infrastructure Bottlenecks leading to low average speeds. • Freight train speeds lowest in the world, i.e. 25km/hr. • Poor track record of project completion. • Lacklustre growth in revenues - both passenger and freight. • Poor operating ratio (i.e. % age of revenues account for expenses) which is expected to be 92% for 2016-17 which was 90% in 2015-16. • Unhygienic condition of pantry car. • Poor quality of food supplied to passengers. • Dirty toilets • Toilet facilities are absent in EMU trains. • Stations are not clean. • Toilets at stations are in very bad conditions. • Maintenance and overhead expenses are very high. • Lack of flexibility in routes and turnings.

Strengths	Weaknesses
<ul style="list-style-type: none">• It has solar power run trains.• It has almost 7500 railway stations.• It manufactures locomotives and engines indigenously.• Its Electric Locomotives are manufactured at Chittaranjan Locomotive Works (W. Bengal)• Its Diesel Locomotives are manufactured in Varanasi.• Soon India is going to get the first Bullet train from Japan to run between Mumbai and Ahmedabad.• Indian railways networks are divided into 16 zones.• Fairy Queen - the oldest working steam locomotives engine in the world and it is the oldest steam engine in operation hauling luxurious train from Delhi to Alwar for tourists. It secured a place in the Guinness Book of World record and got Heritage Award at Int'l Tourist Bureau, Berlin in March, 2000.• Electric Multiple Units (EMU) coaches are used in large cities -mainly Mumbai, Chennai, Delhi, Kolkata, Pune, Hyderabad, Bangalore, etc.• In 2016, the fastest train in India is the Bhopal Shatabdi that runs with a top speed of 150 km/h.• 'Gatimaan Express' first proposed in July 2014, India's first semi-high speed bullet train had a successful trial run from Delhi to Agra in 90 minutes. Its maximum speed will be 200 km/h. It will run at a speed of 160 km/h.• Darjeeling Himalayan Railways attained the World Heritage status from UNESCO.• Indian Railways revenue estimates of 2016-17 is Rs.1,84,820 crore.	<ul style="list-style-type: none">• Lack of door to door services.• Inefficiency and high costs are due to lack of competition.• Unsuitable for short distance and small roads.• More time & Labour required in booking & delivery of goods.• Not rural area oriented.• Under-utilisation of its capacity.• Over centralised administration• It is a hostage of vote bank politics to offer populist measures.• Free travels for politicians, government employees and ministers is negative for its economy.• Reserved seats for politicians and higher dignitaries reflects bad impressions.

SWOT ANALYSIS

Indian Railways

Opportunities	Threats
<ul style="list-style-type: none"> • Indian Railways can capture large chunk of container traffic by introducing block container trains at passenger speeds. • Its 70% revenue comes from freight sector and has scope to add more companies. • Its Operating Ratio (OR) has been decreasing drastically in last 10 years has further scope. • Monetisation from non-tariff measure-advertising, leasing of land adjacent to rail network, data analytics with the available data. • Asset monetisation • Creation of dedicated freight corridors and increased focus on containerisation. • Improving traveller amenities and customer experiences. • Website of Indian Railway catering and Tourism Corporation can be exploited for economic activities. • Green track for Road Railer Service can increase penetration into non-freight segment of companies/regions. • Technological upgradation (i.e. Wi-Fi, Mobile applications, e-commerce platform, etc.) can improve customer interface and monitoring of project implementation. • 2016 budget puts spotlight on over-stressed suburban (EMU) train services in metros like Mumbai, Kolkatta & Delhi. • Railways Minister has proposed to revive the Ring Rail network in Delhi and two new corridors in Mumbai. • Rail Budget 2016 has proposed to develop 3 freight corridors, draft a freight train timetable, increase the speed to 50 kms/hr and build rail side logistics parks & ware houses. • Rail Budget 2016-Vision 2020 for on demand reservation, technology for safety, Punctuality -95%, Freight trains time-table, increased average speed, etc. • By 2020 there will be zero direct discharge of human waste. • By 2020 unmanned crossing will be eliminated. • Budget 2016 has proposed new structure for railways by - Cooperation, Collaboration, Creativity and Communication. • The IR minister Prabhu's 3 pronged strategies to overhaul the operating efficiency are Reorganise, restructure and rejuvenate. • 1.21 lakh crore Rupees proposed investment for 2016-17 should facilitate modernization of the Railways. • Railway Budget 2016 has proposed to start- Antyodaya Express – a long distance, unreserved, superfast-train. • Indian Railways has proposed to launch 3 select train services – Humsafar, Tejas and UDAY. • Indian Railways has proposed e-ticketing to be opened to foreign cards for tourists, NRIS. • It has proposed 44 new partnership works valued at about `92,714 crore to be implemented. 	<ul style="list-style-type: none"> • Open railway tracks can cause any disaster for trains, travellers, goods, etc. • Chain-pulling to stop train anywhere is a serious threat by terrorists. • Unchecked boarding at majority of stations can cause major mishappenings. • Very high competition from road and low cost airlines in passengers and freight. • Over dependence on low yield bulk cargo (currently 10 commodities account for 80% of the freight). • Increase in allowable gross weight of road vehicle. • Possible introduction of double road trailers. • Finding the money over Rs.1.21 lakh crore that is targeted to be invested in 2016-17. • High democratic /political presence against higher tariffs. • Indian Railways has faced twin headwinds from the tepid economy and the impact of 7th pay commission award. • The operating ratio improved from 98% in 2001 to 76% in 2008. But now it has again reached to 92% for 2017. • Tatkal ticket booking is not working either on window or on e-ticketing for direct general public. • There are 10000 unmanned railways crossing all over the country. • Corruption at every level is a threat for its development, services, security and safety. • Passengers especially older people, women and children are not safe. • There is security threat in IT system of railways. • Mumbai suburban Railway is most severe overcrowding accident prone in the world.

RAILWAY BUDGET 2016

Railway Budget 2016 was presented on February 25, 2016 by Suresh Prabhu, the Railway Minister of India. Here are the highlights of the rail budget 2016:

- No hike in passenger fares.
- Swacch Bharat: 17000 biotoilets and additional toilets in 475 stations before the close of this financial year.
- Wifi at 100 stations this year and 400 stations next year.
- 33% reservation to women in reserved quota in Railways to be introduced.
- Deen Dayal coaches for long distance trains for unreserved passengers. These coaches will include potable water and higher number of mobile charging points.
- Janani Sewa: Children's menu, baby foods, baby boards to be made available for travelling mothers.
- Overnight double-decker train Uday Express to be introduced on busiest routes, carrying capacity to be 40% more.
- Porters not to be called "coolies" but be called "sahayaks" now; will be trained in soft skills.
- Railways to increase lower berth quota for senior citizens by 50%.
- Ajmer, Amritsar, Gaya, Mathura, Nanded, Nashik, Puri, Tirupati, Varanasi, Nagapattinam and other pilgrim stations to be beautified.
- Bar-coded tickets to be introduced at select stations on pilot basis to tackle nuisance of ticketless travel.
- Two elevated suburban railway corridors – Churchgate-Virar and CST-Panvel to be constructed in Mumbai; Ring railway covering 21 stations to be revived with state participation.
- GPS-based digital display in coaches for showing upcoming stations.
- North-East India, especially Mizoram and Manipur, to be connected through broad gauge soon.
- 1,600 km of electrification this year and 2,000 km proposed for the next year.
- Introduced 1,780 Automatic Ticket Vending Machines, mobile apps & GoIndia smartcard for cashless purchase of UTS and PRS tickets, enhanced capacity of e-ticketing system from 2,000 tickets per minute to 7,200 tickets per minute and to support 1,20,000 concurrent users as against only 40,000 earlier.
- Propose to invite FM Radio stations for providing train-borne entertainment; extend 'Rail Bandhu' to all reserved classes of travelers and in all regional languages.

FOR MORE JOIN ~ MISSION SSC / BANKING / UPSC

CA-8

Railway Budget 2016

-
- Security through helplines & CCTVs; Safety - 350 manned level crossings closed, eliminated 1,000 unmanned level crossings, 820 ROB/RUB completed in the current year and work going on in 1,350 of them.
 - SMART (Specially Modified Aesthetic Refreshing Travel) Coaches are redesigned coaches with redesigned bio-vaccum toilets, vending machines, advertising boards, PA system, dustbins, ergonomic seating.
 - Clean my Coach: Passengers will be able to demand cleaning of a toilet via SMS. The audit will be done by third party and action to be taken based on passenger feedback.
 - Tejas: It will showcase the future of train travel in India with operating speeds of 130 kmph.
 - Rail Mitra Sewa: Expanding Sarathi Seva in Konkan Railway to help the old and disabled passengers, strengthening the existing services for enabling passengers to book battery operated cars, porter services, etc. on a paid basis in addition to the existing pick up and drop, and wheel chair services.

ARITHMETIC

1. The value of $\left(\frac{-1}{216}\right)^{-\frac{2}{3}}$ is :
- (a) $\frac{1}{36}$ (b) $-\frac{1}{36}$
 (c) -36 (d) 36
2. The unit's digit in the product $7^{35} \times 3^{71} \times 11^{55}$ is :
- (a) 1 (b) 3
 (c) 7 (d) 9
3. When the price of a radio was reduced by 20%, its sale increased by 80%. What was the net effect on the sale?
- (a) 44% increase (b) 44% decrease
 (c) 66% increase (d) 75% increase
4. How much water must be added to 48 ml of alcohol to make a solution that contains 25% alcohol ?
- (a) 24 ml (b) 72 ml
 (c) 144 ml (d) 196 ml
5. Ravi's salary is 150% of Amit's salary. Amit's salary is 80% of Ram's salary. What is the ratio of Ram's salary to Ravi's salary ?
- (a) 1 to 2 (b) 2 to 3
 (c) 5 to 6 (d) 6 to 5
6. A sum of money invested at compound interest amounts in 3 years to ₹ 2,400 and in 4 years to ₹ 2,520. The interest rate per annum is :
- (a) 6% (b) 5%
 (c) 10% (d) 12%
7. A man borrows ₹ 6000 at 10% compound rate of interest. He pays back ₹ 2000 at the end of each year to clear his debt. The amount that he should pay to clear all his dues at the end of third year is
- (a) ₹ 6000 (b) ₹ 3366
 (c) ₹ 3060 (d) ₹ 3066
8. At what percentage above the cost price must an article be marked so as to gain 33% after allowing the customer a discount of 5% ?
- (a) 48% (b) 43%
 (c) 40% (d) 38%
9. The batting average of 40 innings of a cricket player is 50 runs. His highest score exceeds his lowest score by 172 runs. If these two innings are excluded, the average of the remaining 38 innings is 48. His highest score was :
- (a) 172 (b) 173
 (c) 174 (d) 176
10. The lengths of three sides of a triangle are known. In which of the cases given below, it is impossible to get a triangle ?
- (a) 15 cm, 12 cm, 10 cm
 (b) 3.6 cm, 4.3 cm, 5.7 cm
 (c) 17 cm, 12 cm, 6 cm
 (d) 2.3 cm, 4.4 cm, 6.8 cm
11. The perimeters of two similar triangles ABC and PQR are 36 cm, and 24 cm, respectively. If PQ = 10 cm, then the length of AB is :
- (a) 16 cm (b) 12 cm
 (c) 14 cm (d) 15 cm
12. Two isosceles triangles have equal vertical angles and their areas are in the ratio 9 : 16. The ratio of their corresponding heights is :
- (a) 3 : 4 (b) 4 : 3
 (c) 2 : 1 (d) 1 : 2
13. If in the following figure, PA = 8 cm, PD = 4 cm, CD = 3 cm, then AB is equal to :

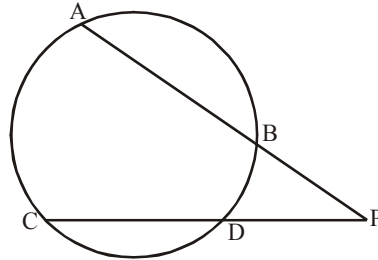

- (a) 3.0 cm (b) 3.5 cm
 (c) 4.0 cm (d) 4.5 cm
14. In a triangle ABC, $\angle A = x$, $\angle B = y$ and $\angle C = y + 20$. If $4x - y = 10$, then the triangle is :
- (a) Right-angled (b) Obtuse-angled
 (c) Equilateral (d) None of these

15. Which one of the following is a factor of $x^3 - 19x + 30$?
 (a) $x - 2$ (b) $x + 2$
 (c) $x - 1$ (d) $x + 1$
16. If $2x^2 - 7xy + 3y^2 = 0$, then the value of $x : y$ is :
 (a) 3 : 2 (b) 2 : 3
 (c) 3 : 1 or 1 : 2 (d) 5 : 6
17. If $27 \times (81)^{2n+3} - 3^m = 0$, then what is m equal to?
 (a) $2n + 5$ (b) $5n + 6$
 (c) $8n + 3$ (d) $8n + 15$
18. If $\tan A = -\frac{1}{2}$ and $\tan B = -\frac{1}{3}$, then $A + B =$
 (a) $\frac{\pi}{4}$ (b) $\frac{3\pi}{4}$
 (c) $\frac{5\pi}{4}$ (d) None of these
19. $\cos 1^\circ \cdot \cos 2^\circ \cdot \cos 3^\circ \dots \cos 179^\circ$ is equal to—
 (a) -1 (b) 0
 (c) 1 (d) $1/\sqrt{2}$
20. If $\tan 15^\circ = 2 - \sqrt{3}$, then the value of $\cot^2 75^\circ$ is—
 (a) $7 + \sqrt{3}$ (b) $7 - 2\sqrt{3}$
 (c) $7 - 4\sqrt{3}$ (d) $7 + 4\sqrt{3}$

DIRECTIONS (Qs. 21 to 23) : The following table, gives the annual production (in thousands) of 5 products of a famous toy company. Study the table and then answer the questions that follow :

Year	Ludo	Scrabble	Chess	Monopoly	Carrom
1992	200	150	78	90	65
1993	150	180	100	105	70
1994	180	175	92	110	85
1995	195	160	120	125	75
1996	220	185	130	135	80

21. What is the approximate percentage increase in the production of Monopoly form 1993 to 1995?
 (a) 10 (b) 20
 (c) 5 (d) 25
22. For which toy category there has been a continuous increase in the production over the years?
 (a) Ludo (b) Chess
 (c) Monopoly (d) Carrom
23. What is the percentage drop in the production of Ludo from 1992 to 1994 ?
 (a) 30 (b) 50
 (c) 20 (d) 10
24. A circle road runs around a circular garden. If the difference between the circumference of the outer circle and the inner circle is 44 m, the width of the road is
 (a) 4 m (b) 7 m
 (c) 3.5 m (d) 7.5 m
25. The perimeter of a square whose area is equal to that of a circle with perimeter $2\pi x$ is :
 (a) $2\pi x$ (b) $\sqrt{\pi x}$
 (c) $4x\sqrt{\pi}$ (d) $4\pi\sqrt{x}$
26. The value of $(243)^{0.16} \times (243)^{0.04}$ is equal to :
 (a) 0.16 (b) 3
 (c) $\frac{1}{3}$ (d) 0.04
27. $\sqrt{17 + \sqrt{51 + \sqrt{152 + \sqrt{289}}}} = ?$
 (a) 3 (b) 5
 (c) 8 (d) 11
28. If the L.C.M and H.C.F. of two numbers are 2400 and 16, one number is 480; find the second number.
 (a) 40 (b) 80
 (c) 60 (d) 50
29. The average age of 80 boys in a class is 15. The average age of a group of 15 boys in the class is 16 and the average age of another 25 boys in the class is 14. What is the average age of the remaining boys in the class ?
 (a) 15.25 (b) 14
 (c) 14.75 (d) Cannot be determined
30. By selling a table for Rs 330, a trader gains 10%. Find the cost price of the table.
 (a) 300 (b) 363
 (c) 297 (d) 270
31. If a dividend of ₹ 57,834 is to be divided among Meena, Urmila and Vaishali in the proportion of 3:2:1, find Urmila's share.
 (a) ₹ 19,281 (b) ₹ 17,350
 (c) ₹ 23,133 (d) ₹ 19,278
32. A certain number of men can do a work in 60 days. If there were 8 men more it could be finished in 10 days less. How many men are there ?
 (a) 75 men (b) 40 men
 (c) 48 men (d) 45 men

33. A cyclist covers a distance of 750 m in 2 min 30 sec. What is the speed in km/h of the cyclist ?
 (a) 18 km/h (b) 15 km/h
 (c) 20 km/h (d) None of these
34. A horse is tethered to one corner of a rectangular grassy field 40 m by 24 m with a rope 14 m long. Over how much area of the field can it graze?
 (a) 154 cm² (b) 308 m²
 (c) 150 m² (d) None of these
35. A dishonest dealer sells his goods at the cost price but still earns a profit of 25% by underweighing. What weight does he use for a kg?
 (a) 750 g (b) 800 g
 (c) 825 g (d) 850 g
36. A can do a piece of work in 9 days and B in 18 days. They begin together, but A goes away 3 days before the work is finished. The work lasts for
 (a) 6 days (b) 8 days
 (c) 12 days (d) 10 days
37. If a man walks to his office at $\frac{5}{4}$ of his usual rate, he reaches office 30 minutes early than usual. What is his usual time to reach office.
 (a) 2 hr (b) $2\frac{1}{2}$ hr
 (c) 1 hr 50 min (d) 2 hr 15 min
38. If $(3.7)^x = (0.037)^y = 10000$, then what is the value of $\frac{1}{x} - \frac{1}{y}$?
 (a) 1 (b) 2
 (c) $\frac{1}{2}$ (d) $\frac{1}{4}$
39. $(a + b + c)^2 - (a - b - c)^2 = ?$
 (a) $4a(b + c)$ (b) $2a(b + c)$
 (c) $3a(b + c)$ (d) $4a(b - c)$
40. If $\operatorname{cosec} 39^\circ = x$, the value of $\frac{1}{\operatorname{cosec}^2 51} \sin^2 39 \tan^2 51 - \frac{1}{\sin^2 51 \sec^2 39}$ is
 (a) $\sqrt{x^2 - 1}$ (b) $\sqrt{1 - x^2}$
 (c) $x^2 - 1$ (d) $1 - x^2$

GENERAL INTELLIGENCE & REASONING

DIRECTIONS (Qs. 41-43) : In questions, select the related word/letters/number from given alternatives.

41. Crime : Court : : Disease : ?
 (a) Doctor (b) Medicine
 (c) Hospital (d) Treatment

42. ADGJ : BEHK :: DGJM : ?
 (a) KPUB (b) GJMP
 (c) KNQT (d) PSVY
43. 7 : 56 :: 5 : ?
 (a) 25 (b) 26
 (c) 30 (d) 35

DIRECTIONS (Qs. 44-45) : In questions, find the odd word/letters/number pair from the given alternatives.

44. (a) Cabbage (b) Carrot
 (c) Potato (d) Beetroot
45. (a) GFI (b) VUX
 (c) POR (d) LKM

DIRECTIONS (Qs. 46-47) : In questions, a series is given, with one term missing. Choose the correct alternative from the given ones that will complete the series.

46. CGJ, KOR, TXA, ___ ?
 (a) ACE (b) JDP
 (c) FJM (d) UWY
47. B-1, D-2, F-4, H-8, J-16, ___ ?
 (a) K-64 (b) L-32
 (c) M-32 (d) L-64

DIRECTION (Qs. 48) : In question, find the missing number from the given responses.

48. If $A = 1$, $B = 2$ and $N = 14$, then BEADING = ?
 (a) 2154(14)97 (b) 2514(14)79
 (c) 25149(14)7 (d) 2154(14)79
49. Arrange the letters to form a word and suggest what is it.
 NGDEALN
 (a) State (b) Country
 (c) River (d) Ocean

DIRECTIONS (Qs. 50) : In question, which one set of letters when sequentially placed at the gaps in the given letter series shall complete it ?

50. a _ n _ b _ _ n c b _ _ n c b
 (a) b c a b a b (b) b a c b a b
 (c) a b c b c b (d) a b b c c a
51. In a class of 45 students, a boy is ranked 20th. When two boys joined, his rank was dropped by one. What is his new rank from the end ?
 (a) 25th (b) 26th
 (c) 27th (d) 28th
52. Introducing a girl, Ram said to his son-in-law. "Her brother is the only son of my brother-in-law." Who is the girl of Ram?
 (a) Sister-in-law (b) Niece
 (c) Daughter (d) Sister

53. If an electric train runs in the direction from North to South with a speed of 150 km/hr covering 2000 km, then in which direction will the smoke of its engine go ?
 (a) N→S (b) S→N
 (c) E→W (d) No direction
54. Which figure represents the relation among Computer, Internet and Information Communication Technology?

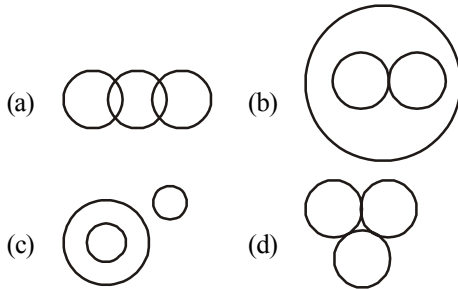

55. Choose the correct alternative.

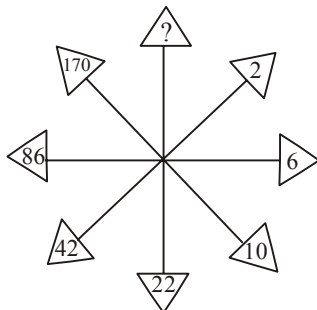

- (a) 422 (b) 374
 (c) 256 (d) 342
56. Murthy drove from town A to town B. In the first hour, he travelled $\frac{1}{4}$ of the journey. In the next one hour, he travelled $\frac{1}{2}$ of the journey. In the last 30 minutes, he travelled 80 km. Find the distance of the whole journey.
 (a) 240km (b) 300 km
 (c) 320km (d) 360 km
57. Find the answer of the following:
 $7 + 3 = 421$
 $11 + 7 = 477$
 $9 + 5 = 445$
 $6 + 2 = ?$

- (a) 444 (b) 412
 (c) 475 (d) 487
58. A, B, C, D and E are five boys sitting in a circle facing the centre. C is sitting immediately to the left of E. A is sitting between D and E. Then, who is sitting between B and A?
 (a) C (b) E
 (c) D (d) None of these

DIRECTION (Qs. 59): In question, one statement is given, followed by three conclusions, I, II, and III. You have to consider the statements to be true, even if they seem to be at variance from commonly known facts. You are to decide which of the given Conclusions can definitely be drawn from the given statement(s). Indicate your answer.

59. Statements:

- SAGE is a reputed publisher of both journals and books.
- All publishing of SAGE is highly qualitative.

Conclusions:

- SAGE publishes qualitative articles.
- SAGE did not publish lowest quality articles.
- SAGE enriches its publications by high scrutinization.

- (a) Only conclusion III
 (b) All conclusions .
 (c) Only conclusions I and II
 (d) Only conclusions II and III

60. If a mirror is placed on the line MN, then which of the answer figures is the correct image of the question figure?

Question figure:

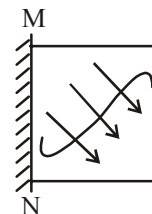

Answer figures :

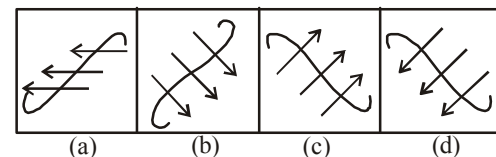

61. Identify the answer figure from which the pieces given in question figure have been cut.

Question figure :

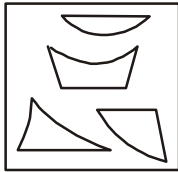

Answer figures:

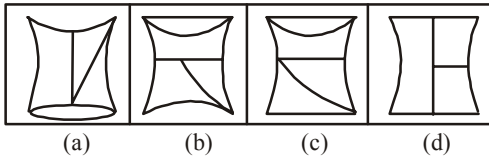

DIRECTIONS (Qs. 62) : In question, which answer figure will complete the pattern in the question figure?

62. Question figure:

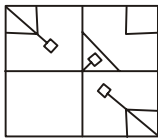

Answer Figures :

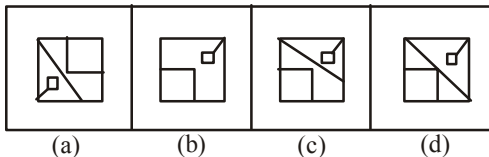

63. Which of the answer figures is not made up only by the components of the question figure ?

Question figure:

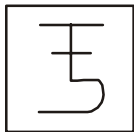

Answer figures:

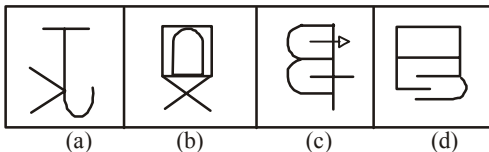

64. A piece of paper is folded and cut as shown below in the question figures. From the given answer figures, indicate how it will appear when opened.

Question figure:



Answer Figures :

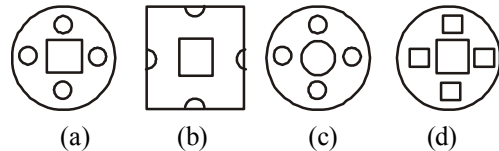

65. A word is represented by one set of numbers as given in any one of the alternatives. The sets of numbers given in the alternatives are represented by two classes of alphabets as in two matrices given below. The columns and rows of Matrix I are numbered from 0 to 4 and that of Matrix II are numbered from 5 to 9. A letter from these matrices can be represented first by its row and next by its column e.g., 'A' can be represented by 40, 01, 13, 32, and 'N' can be represented by 56, 68, 89 etc. Similarly, you have to identify the set for the word given below :

SIX-KIDS

Matrix-I

	0	1	2	3	4
4	A	F	K	P	U
3	F	K	A	U	P
2	P	U	F	K	A
1	K	P	U	A	F
0	U	A	P	F	K

Matrix-II

	5	6	7	8	9
9	D	I	N	S	X
8	X	S	I	D	N
7	N	X	S	I	D
6	S	D	X	N	I
5	I	N	D	X	S

- (a) 86, 87, 99 – 40, 41, 86, 64
- (b) 98, 96, 85 – 42, 78, 88, 77
- (c) 77, 69, 76 – 22, 95, 28, 31
- (d) 65, 55, 67 – 05, 25, 91, 40

66. Which is the third number to the left of the number which is exactly in the middle of the following sequence of numbers?
1 2 3 4 5 6 7 8 9 2 4 6 8 9 7 5 3 9 8 7 6 4 3 2 1
(a) 3 (b) 2 (c) 5 (d) 6
67. In a certain code IDEAS is written as HEDBR and WOULD is written as VPTMC. How will RIGHT be written in the same code?
(a) QJHIS (b) SHHGU
(c) QJFIU (d) QJFIS
68. If the alphabet is written in the reverse order and every alternate letter starting with Y is dropped, which letter will be exactly in the middle of the remaining letters of the alphabet.
(a) M (b) N (c) O (d) Mor O
69. In a row of girls, Rita and Monika occupy the ninth place from the right end and tenth place from the left end, respectively. If they interchange their places, then Rita and Monika occupy seventeenth place from the right and eighteenth place from the left respectively. How many girls are there in the row?
(a) 25 (b) 26
(c) 27 (d) Data inadequate
70. In a certain code language 'Ka Bi Pu Ya' means 'You are very intelligent' 'Ya Lo Ka Wo' means 'They seem very intelligent' 'La Pu Le' means 'You can see' and 'Sun Pun Yun Ya' means 'how intelligent she is', In that language, which of the following words means 'are'?
(a) Ka (b) Bi (c) Ya (d) Pu
71. Ankit is related to Binny and Chinky, Daizy is Chinky's mother. Also Daizy is Binny's sister and Aruna is Binny's sister. How is Chinky related to Aruna?
(a) Niece (b) Sister
(c) Cousin (d) Aunt
72. Rama remembers that she met her brother on Saturday, which was after the 20th day of a particular month. If the 1st day of that month was Tuesday, then on which date did Rama meet her brother?
(a) 24th (b) 23rd (c) 25th (d) 26th
73. If it is possible to make only one such number with the first, the fourth and the sixth digits of the number 531697 which is the perfect square of a two digit even number, which of the following will be the second digit of the two digit even number. If no such number can be made, give '@' as the answer and if more than one such number can be made, give '©' as the answer.
(a) 4 (b) 2 (c) 6 (d) @
74. In a certain code JOURNEY is written as TNISZFO. How is MEDICAL written in that code?
(a) CDLJMBD (b) CDWDBM
(c) LDCJMBD (d) EFNJMBD
75. If 'K' denotes '×', 'B' denotes '÷', 'T' denotes '-' and 'M' denotes '+', then –
40 B 8 T 6 M 3 K 4 = ?
(a) 19 (b) 11 (c) -31 (d) 23

DIRECTIONS (Qs. 76-78) : In each question below, is given a group of letters followed by found combinations of digits/symbols numbered (a), (b), (c) and (d). You have to find out which of the four combinations correctly represents combination as your answer. If none of the combinations correctly represents the group of letters, mark (e) 'None of these', as your answer:

Letter	R	E	A	U	M	D	F	P	Q	I	O	H	N	W	Z	B
Digit/Symbol code	7	#	\$	6	%	8	5	★	4	9	@	©	3	D	1	2

- (i). If the first letter is a consonant and the third letter is a vowel, their codes are to be interchanged.
- (ii). If the first letter is a vowel and the fourth letter is a consonant, both are to be coded as the code for the vowel.
- (iii). If the second and the third letters are consonants, both are to be coded as the code for the third letter.
76. HUBDIN
(a) ©62893 (b) ©2689%
(c) ©6289© (d) ©62©9%
77. NABAQE
(a) 263\$4# (b) 326\$4#
(c) 362\$4# (d) None of these
78. FWZERA
(a) 5D#7\$ (b) 5DD#7\$
(c) D17#\$ (d) 511#7\$

DIRECTIONS (Qs. 79-80) : Study the following information and answer the questions given below it.

Seven people—A, B, C, D, E, F and G are sitting in a circle. Five of them are facing the centre while two of them are facing opposite to the centre. C sits third to the left of D and both are facing the centre. E is neither on immediate neighbour of D nor of C. The one sitting exactly between D and F is facing opposite to centre. G sits third to the right of A and G is facing the centre. One of B's neighbour is facing opposite to the centre.

79. Which of the following pairs represents persons facing opposite to the centre?
 (a) A and F
 (b) E and F
 (c) A and E
 (d) Cannot be determined
80. Who is sitting second to the left of A?
 (a) C (b) G (c) E (d) B

GENERAL AWARENESS

81. Which of the following symbiotic associations forms a lichen?
 (a) An algae and a fungus
 (b) An algae and a bryophyte
 (c) A bacterium and a fungus
 (d) A bacterium and a gymnosperm
82. The headquarters of which one of the following organizations is not in Geneva?
 (a) Food and Agricultural Organisation
 (b) World Meteorological Organisation
 (c) World Health Organisation
 (d) World Trade Organisation
83. The opportunity cost of a factor of production is
 (a) what it earns in its present use.
 (b) what it can earn in the long period.
 (c) what it can earn in some other use.
 (d) the cost of production.
84. Which Amendment Act is referred as mini constitution?
 (a) 7th Constitutional Amendment Act, 1956
 (b) 24th Constitutional Amendment Act, 1971
 (c) 42nd Constitutional Amendment Act, 1976
 (d) 44th Constitutional Amendment Act, 1978
85. Inflation is caused by
 (a) decrease in production
 (b) increase in money supply and decrease in production
 (c) increase in money supply
 (d) increase in production
86. The equilibrium of a firm under perfect competition will be determined when
 (a) Marginal Cost > Average Cost
 (b) Marginal Revenue > Average Cost
 (c) Marginal Revenue > Average Revenue
 (d) Marginal Revenue = Marginal Cost
87. Which one of the following cities and the personalities associated with their establishment is wrongly matched?
 (a) Calcutta – Robert Clive
 (b) Pondicherry – Francis Martin
 (c) Ahmedabad – Ahmad Shah I
 (d) Madras – Francis Day
88. Arihant is a
 (a) Multi barrel rocket launcher
 (b) Airborne Early Warning and Control System
 (c) Unarmed Combat Aerial Vehicle
 (d) Nuclear-powered ballistic missile submarine
89. Which of the following is *not* a laid down principle of the Panchsheel?
 (a) Mutual respect for each other's territorial integrity
 (b) Mutual non-aggression
 (c) Mutual support for each other in world forum
 (d) Mutual non-interference in each other's internal affairs
90. Denatured alcohol
 (a) is a form of alcohol
 (b) is unfit for drinking as it contains poisonous substances
 (c) contains coloured impurities
 (d) is sweet to taste
91. The city of Prayag was named Allahabad - the city of Allah by
 (a) Aurangzeb (b) Akbar
 (c) Shahjahan (d) Bahadur Shah Zafar
92. Arrange the following historical events chronologically choosing the correct response:
 I. French Revolution
 II. Glorious Revolution
 III. American War of Independence
 IV. Russian Revolution
 (a) I II III IV
 (b) II III I IV
 (c) II I IV III
 (d) III II I IV
93. Chromosomes are made up of
 (a) DNA (b) Protein
 (c) DNA and Protein (d) RNA
94. While the computer executes a program, the program is held in
 (a) RAM (b) ROM
 (c) Hard Disk (d) Floppy Disk
95. Presidential form of government consists of the following?
 (a) Popular election of the President
 (b) No overlap in membership between the executive and the legislature
 (c) Fixed term of office
 (d) All of the above
96. Which of the following places of Sikh religious heritage is not in India?
 (a) Nankana Sahib (b) Nanded
 (c) Paonta Sahib (d) Keshgarh Sahib

97. The total population divided by available arable land area is referred to as
 (a) Population density
 (b) Nutritional density
 (c) Agricultural density
 (d) Industrial density
98. The danger signals are red while the eye is more sensitive to yellow because
 (a) absorption in red is less than yellow and hence red is visible from a distance
 (b) scattering in yellow light is less than red
 (c) the wavelength of red light is more than yellow light
 (d) none of the above reasons
99. Who was the author of "India of My Dreams" ?
 (a) J.B. Kripalani (b) M.K. Gandhi
 (c) G.K. Gokhale (d) Jawaharlal Nehru
100. How many players are there in a Polo team ?
 (a) 4 (b) 7 (c) 8 (d) 6
101. Hemophilia is –
 (a) caused by bacteria (b) caused by virus
 (c) caused by pollutants (d) a hereditary defect
102. In human body, vitamin A is stored in the –
 (a) liver (b) skin
 (c) lung (d) kidney
103. Odometer is a –
 (a) Measuring instrument for distance covered by motor wheels
 (b) Measuring instrument for frequency of electromagnetic waves
 (c) Device for measuring sound intensity
 (d) Measuring instrument for electric power
104. Which acid is used in rubber, textile, leather and electroplating industries ?
 (a) Ethanoic acid (b) Methanoic acid
 (c) Malanic acid (d) Butairic acid
105. What is the theme of 2016 National Statistics Day?
 (a) Social Development
 (b) Trees and their calculative lives
 (c) Human empowerment
 (d) Agriculture and Farmers' welfare
106. What is the main folder on a storage device called?
 (a) Root directory (b) Interface
 (c) Device driver (d) Platform
107. To view information on the web you must have a
 (a) Cable modem (b) Web browser
 (c) Domain Name Server
 (d) Hypertext viewer
108. A file is often referred to as a(n)
 (a) Wizard (b) Document
 (c) Pane(d) Device
109. To protect yourself from computer hacker intrusions you should install a
 (a) Firewall (b) Mailer
 (c) Macro (d) Script
110. What type of computers are client computers (most of the time) in a client-server system?
 (a) Mainframe (b) Mini-computer
 (c) Microcomputer (d) PDA
111. When was the first train steamed off in India?
 (a) 1848 (b) 1853
 (c) 1875 (d) 1880
112. Which of the following is the headquarters of the newly established railway zone 'East Coast Railways'?
 (a) Vishakhapatnam (b) Kolkata
 (c) Hyderabad (d) Bhubaneswar
113. Which train in India has the longest route length?
 (a) Howrah - Jammu Tawi Himgiri Express
 (b) Kanyakumari - Jammu Tawi Himsagar Express
 (c) Kanyakumari - Dibrugarh Vivek Express
 (d) Guwahati-Thiruvanthapuram Express
114. Where is the Railway Staff College located?
 (a) Pune (b) Delhi
 (c) Vadodara (d) Allahabad
115. On which of the following is the longest railway bridge in India located?
 (a) River Ganges (b) Vembanad Lake
 (c) River Brahmaputra (d) Chilka Lake
116. Who of the following was declared as Person of the Year 2016 by Time Magazine?
 (a) Angela Merkel (b) Nigel Farage
 (c) Donald Trump (d) Narendra Modi
117. Which is the most powerful language as per the 2016 World Power Language Index (PLI)?
 (a) English (b) French
 (c) Spanish (d) Mandarin
118. Which of the following parliamentary constituency recently became India's first to have health insurance for all?
 (a) Vijayawada (b) Guntur
 (c) Karimganj (d) Araria
119. Which Indian E-Commerce website has launched it's Toll-Free number on December 7, 2016, to enable the users make transaction through mobile phones even without an internet connection ?
 (a) Flipkart (b) Snapdeal
 (c) Amazon (d) Paytm
120. Who has been chosen as the new French Prime Minister replacing Manuel Valls who announced his resignation on December 6, 2016?
 (a) Francois Hollande (b) Bernard Cazeneuve
 (c) Bruno Le Roux (d) Alian Juppe

Hints & Explanations

1. (d) $\left(\frac{-1}{216}\right)^{-\frac{2}{3}} = \left(\frac{-1}{6^3}\right)^{-\frac{2}{3}}$
 $= \left(-\frac{1}{6}\right)^2 = (-6)^2 = 36$
2. (a) Unit's digit in $(7^4) = 1$. Therefore, unit's digit in $(7^4)^8$ i.e. 7^{32} will be 1. Hence, unit's digit in $(7)^{35} = 1 \times 7 \times 7 \times 7 = 3$
 Again, unit's digit in $(3)^4 = 1$
 Therefore, unit's digit in the expansion of $(3^4)^{17} = (3)^{68} = 1$
 \Rightarrow Unit's digit in the expansion of $(3^{71}) = 1 \times 3 \times 3 \times 3 = 7$
 and unit's digit in the expansion of $(11^{35}) = 1$
 Hence, unit's digit in the expansion of $7^{35} \times 3^{71} \times 11^{55} = 3 \times 7 \times 1 = 1$
3. (a) Let the original price be x and sale be of y units.
 Then, the revenue collected initially $= x \times y$
 Now, new price $= 0.8x$, new sale $= 1.8y$
 Then, new revenue collected $= 1.44xy$
 $\% \text{ increase in revenue} = \frac{0.44xy}{xy} \times 100 = 44\%$
Shortcut Method

$$\text{Net effect} = -20 + 80 + \frac{(-20 \times 80)}{100}$$

$$= 60 - 16 = 44\%$$
4. (c) Let quantity of water to be added be x ml.
 Then, $(x + 48) \times \frac{25}{100} = 48$ or $x = 144$ ml.
5. (c) Let the salary of Ram be ₹ 100.
 Then, salary of Amit = ₹ 80
 and salary of Ravi = 150% of 80 = ₹ 120
 Ratio of Ram's salary to Ravi's salary = 100 : 120 = 5 : 6
6. (b) Let the rate of interest be $r\%$.
 Therefore, $\frac{2520}{2400} = \frac{\left(1 + \frac{r}{100}\right)^4}{\left(1 + \frac{r}{100}\right)^3}$
 $\Rightarrow 1 + \frac{r}{100} = \frac{21}{20}$ or $r = 5\%$
7. (b) Amount = 6000
 Rate = 10%
 First year interest $= \frac{6000 \times 10 \times 1}{100} = ₹ 600$
 At the end of first year amount $= 6000 + 600 - 2000 = 4600$
 At the end of second year
 Interest $= \frac{4600 \times 10 \times 1}{100} = 460$
 At the second year amount $= 4600 + 460 - 2000 = 3060$
 At the end of third year
 Interest $= \frac{3060 \times 10 \times 1}{100} = 306$
 Amount at the end of third year $= 3060 + 306 = ₹ 3366$
 Amount refund in third year = ₹ 3366
8. (c) Let the cost price be ₹ 100.
 Gain of 33% = ₹ 33
 \Rightarrow SP = ₹ 133
 Let the marked price be ₹ x . The SP of ₹ 133 has been arrived after giving a discount of 5% on marked price.
 i.e. $x \times 0.95 = ₹ 133$
 $\Rightarrow x = \frac{133}{0.95} = ₹ 140$
 Required increase = ₹ 140 - ₹ 100 = ₹ 40
 Hence required percentage = 40%.
9. (c) Total score of 40 innings = $40 \times 50 = 2000$
 Total score of 38 innings = $38 \times 48 = 1824$
 Let the highest score be x and the lowest score be y .
 Sum of the highest and the lowest score $= x + y = 2000 - 1824$
 $\Rightarrow x + y = 176$... (i)
 and by question, $x - y = 172$... (ii)
 Solving (i) and (ii), we get $x = 174$

10. (d) To construct a triangle, it is necessary that the sum of any two sides is greater than the third side. Checking with options, we find that it is not possible for the measurements given in (d) as $2.3 + 4.4 < 6.8$.

11. (d)

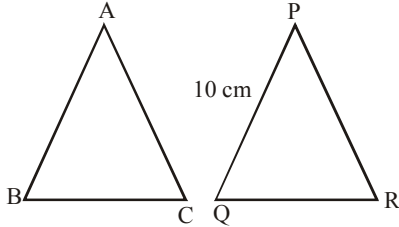

ΔABC and ΔPQR are similar.

$$\frac{AB}{PQ} = \frac{\text{Perimeter of } \Delta ABC}{\text{Perimeter of } \Delta PQR} \Rightarrow \frac{AB}{PQ} = \frac{36}{24}$$

$$\text{or } AB = \frac{36}{24} \times 10 = 15$$

12. (a) For the two similar triangles, we have

$$\frac{h_1^2}{h_2^2} = \frac{\text{Area of I}^{\text{st}} \Delta}{\text{Area of II}^{\text{nd}} \Delta} = \frac{9}{16}$$

$$\Rightarrow h_1 : h_2 = 3 : 4$$

13. (d) We know that
 $PC \times PD = PA \times PB$

$$\Rightarrow PB = \frac{28}{8} = 3.5 \text{ cm}$$

Therefore, $AB = AP - BP = 8 - 3.5 = 4.5 \text{ cm}$

14. (a) We have, $x + y + (y + 20) = 180$

$$\text{or } x + 2y = 160 \quad \dots (i)$$

$$\text{and } 4x - y = 10 \quad \dots (ii)$$

From (i) and (ii), $y = 70, x = 20$

Angles of the triangles are $20^\circ, 70^\circ, 90^\circ$.
 Hence the triangle is a right angled.

15. (a) If $f(x) = 0$ at $x = 0$, then $(x - 0)$ is a factor of $f(x)$.
 Checking with the options, we find that

$$f(2) = (2)^3 - 19 \times (2) + 30 = 0$$

Therefore, $x - 2$ is a factor of $x^3 - 19x + 30$

16. (c) $2x^2 - 7xy + 3y^2 = 0$

$$2\left(\frac{x}{y}\right)^2 - 7\left(\frac{x}{y}\right) + 3 = 0 \quad (\text{Dividing by } y^2)$$

$$\frac{x}{y} = \frac{-b \pm \sqrt{b^2 - 4ac}}{2a}$$

$$= \frac{7 \pm \sqrt{49 - 24}}{2 \times 2} = \frac{7 \pm 5}{4} = 3, \frac{1}{2}$$

$$\Rightarrow \frac{x}{y} = \frac{3}{1} \text{ or } \frac{x}{y} = \frac{1}{2}$$

17. (d) Given, $27 \times (81)^{2n+3} - 3^m = 0$

$$\Rightarrow 3^3 \times (3)^{8n+12} = 3^m$$

$$\Rightarrow 3^{8n+15} = 3^m \Rightarrow m = 8n + 15$$

(on comparing)

18. (b) We have $\tan A = -\frac{1}{2}$ and $\tan B = -\frac{1}{3}$

Now,

$$\tan(A + B) = \frac{\tan A + \tan B}{1 - \tan A \tan B} = \frac{-\frac{1}{2} - \frac{1}{3}}{1 - \left(-\frac{1}{2}\right)\left(-\frac{1}{3}\right)} = -1$$

$$\Rightarrow \tan(A + B) = \tan \frac{3\pi}{4}. \text{ Hence, } A + B = \frac{3\pi}{4}$$

19. (b) $\cos 1^\circ \cdot \cos 2^\circ \cdot \cos 3^\circ \dots \cos 179^\circ$
 As value of $\cos 1^\circ = 0$
 $\therefore \cos 1^\circ \cdot \cos 2^\circ \cdot \cos 3^\circ \dots \cos 179^\circ = 0$

20. (c) $\tan 15^\circ = \cot(90^\circ - 15^\circ) = \cot 75^\circ$

$$\therefore \cot 75^\circ = 2 - \sqrt{3}$$

$$\text{i.e., } \cot^2 75^\circ = (2 - \sqrt{3})^2 = 7 - 4\sqrt{3}$$

21. (b) Percentage increase in the production of

$$\text{monopoly} = \frac{(125 - 105)}{105} \times 100 = \frac{20}{105} \times 100 = 19.05\% \approx 20\%$$

22. (c) Production of monopoly has shown continuous increase over the years.

23. (d) $\% \text{ drop} = \frac{200 - 180}{200} \times 100 = 10\%$

24. (b) Let R be the radius of circular road

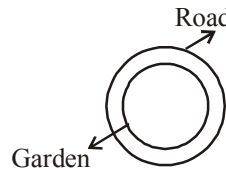

i.e., R = radius of outer circle.

Let r be the radius of inner circle (garden).

circumference of the road = $2\pi R$

circumference of the garden = $2\pi r$

Given : $2\pi R - 2\pi r = 44 \text{ m}$

$$\Rightarrow 2\pi(R - r) = 44 \Rightarrow R - r = 7 \text{ m}$$

Hence, the width of the road = $R - r = 7 \text{ m}$

25. (c) Area of the circle = $\pi (x)^2$ where radius of circle = x

Let side of the square be y .

$$\text{Then, } y^2 = \pi (x)^2 \Rightarrow y = x\sqrt{\pi}$$

$$\text{Perimeter of the square is } = 4y = 4x\sqrt{\pi}$$

26. (b) $(243)^{0.16} \times (243)^{0.04}$

$$= (243)^{0.16+0.04}$$

$$= (243)^{0.2} = (243)^{1/5} = (3^5)^{1/5} = 3$$

27. (b)

$$\sqrt{17 + \sqrt{51 + \sqrt{152 + \sqrt{289}}}} = \sqrt{17 + \sqrt{51 + \sqrt{152 + 17}}}$$

$$= \sqrt{17 + \sqrt{51 + \sqrt{169}}} = 5$$

28. (b) \therefore Product of numbers = (LCM \times HCF)

$$\Rightarrow 480 \times \text{second number} = 2400 \times 16$$

$$\Rightarrow \text{second number} = 80$$

29. (a) Average age of the remaining boys

$$= \frac{(80 \times 15) - (15 \times 16 + 25 \times 14)}{40}$$

$$= \frac{1200 - 590}{40} = 15.25$$

30. (a) S.P. = ₹ 330, Gain = 10%

$$\therefore \text{C.P.} = \left(\frac{100}{100 + \text{Gain \%}} \right) \times \text{S.P.}$$

$$= ₹ \frac{100}{100 + 10} \times 330$$

$$= \frac{100}{110} \times 330 = \text{Rs } 300.$$

31. (d) Share of Urmila in dividend = $\left(\frac{2}{6} \times 57834 \right)$

$$= ₹ 19278$$

32. (b) We have :

x men to the work in 60 days and $(x + 8)$ men do th work in

$(60 - 10 =) 50$ days.

Then by "basic formula", $60x = 50(x + 8)$

$$\therefore x = \frac{50 \times 8}{10} = 40 \text{ men.}$$

33. (a) Speed = $\left(\frac{750}{150} \right)$ m/sec = 5 m/sec

$$= \left(5 \times \frac{18}{5} \right) \text{ km/hr} = 18 \text{ km/hr.}$$

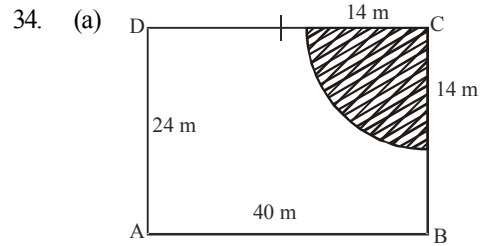

Area of the shaded portion

$$= \frac{1}{4} \times \pi (14)^2 = 154 \text{ m}^2$$

35. (b) $\frac{\text{True weight}}{\text{False weight}} = \frac{100 + \text{gain\%}}{100 + x}$

$$\text{Here S.P.} = \text{C. P.} \therefore x = 0$$

$$\Rightarrow \text{False weight} = \frac{1000 \times 100}{125} = 800 \text{ gm}$$

36. (b) Let work will be completed in x days. Then, work done by A in $(x - 3)$ days + work done by B in x days = 1

$$\frac{x-3}{9} + \frac{x}{18} = 1 \Rightarrow 3x = 24 \Rightarrow x = 8 \text{ days.}$$

37. (b) usual time $\times \left(\frac{4}{5} - 1 \right) = \frac{-30}{60}$

$$\Rightarrow \text{usual time} = \frac{1}{2} \times 5 = 2 \frac{1}{2} \text{ hr}$$

38. (c) Given, $(3.7)^x = (0.037)^y = 10000$

$$\Rightarrow (3.7)^x = 10^4 \text{ and } (0.037)^y = 10^4$$

$$\Rightarrow 37 = 10^{\frac{4}{x}+1} \text{ and } 37 = 10^{\frac{4}{y}+3}$$

$$10^{\frac{4}{x}+1} = 10^{\frac{4}{y}+3} \Rightarrow \frac{4}{x}+1 = \frac{4}{y}+3$$

$$\Rightarrow \frac{4}{x} - \frac{4}{y} = 3 - 1 \Rightarrow \frac{1}{x} - \frac{1}{y} = \frac{1}{2}$$

39. (a) $(a + b + c)^2 - (a - b - c)^2$
 $= (a + b + c + a - b - c)(a + b + c - a + b + c)$
 $= 2a(2b + 2c) = 4a(b + c)$

40. (c) $\frac{1}{\text{cosec}^2 51} \sin^2 39 \tan^2 51 - \frac{1}{\sin^2 51 \sec^2 39}$
 $\frac{\sin^2 51}{\sin^2 51} \frac{\sin^2 39}{\sin^2 39} \frac{\tan^2 (90 - 39)}{1}$
 $-\frac{1}{\sin^2 51 \cdot \sec^2 39}$
 $\cos^2 39 \sin^2 39 \cot^2 39 - \frac{1}{\cos^2 39 \cdot \sec^2 39}$

$$[\because \sin(90^\circ - \theta) = \cos \theta, \tan(90^\circ - \theta) = \cot \theta]$$

$$= 1 + \cot^2 39^\circ - 1 = \text{cosec}^2 39^\circ - 1 = x^2 - 1$$

41. (c) "Court" is the place where the judge gives his decision on crime. Similarly, Hospital is the place where the doctor diagnoses the disease of the patient.

42. (b) As,

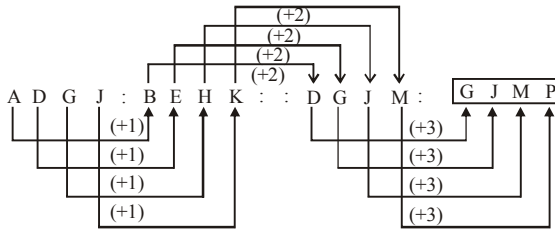

So, GJMP is the correct answer.

43. (c) As,

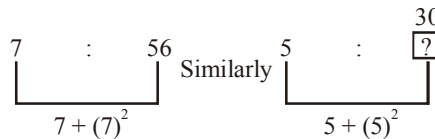

44. (a) All others, except (a) are root vegetables.

45. (d) As,

$$G \xrightarrow{(-1)} F \xrightarrow{(+3)} I$$

$$V \xrightarrow{(-1)} U \xrightarrow{(+3)} X$$

$$P \xrightarrow{(-1)} O \xrightarrow{(+3)} R$$

$$\text{But, } L \xrightarrow{(-1)} K \xrightarrow{(+2)} M$$

So, LKM is odd word

46. (c) The pattern of the series is as follows:

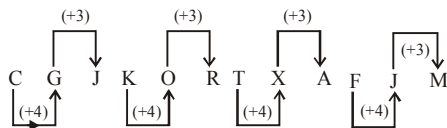

47. (b) The pattern of the series is as follows:

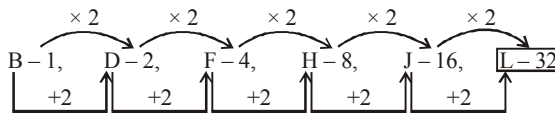

48. (c) It is based on position of English alphabet.

B	E	A	D	I	N	G
↓	↓	↓	↓	↓	↓	↓
2	5	1	4	9	(14)	7

49. (b) After arranging the letters, we get word 'ENGLAND' which is the name of the country.

50. (a) a b n c b / a b n c b / a b n c b

51. (c) After 2 boys joined, total strength of class = $45 + 2 = 47$

As, rank was dropped by one from 20th rank, new rank is 21st.

Rank of the boy from the beginning = 21

No. of students below his rank = $47 - 21 = 26$

Rank from the end = $(47 - 21) + 1 = 27$.

52. (b)

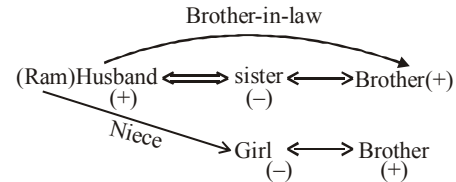

Hence, girl is the niece of Ram.

53. (d) An electric train does not emit smoke. Therefore, no smoke will be going in any of the direction.

54. (b)

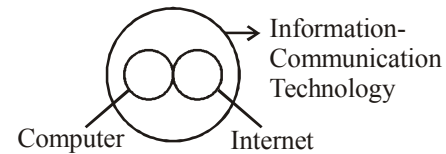

55. (d)

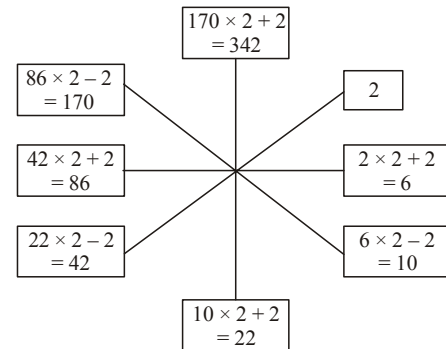

56. (c) Let total Journey = x km.

Ist hour, he travelled = $\frac{x}{4}$ km.

Next hour, he travelled = $\frac{x}{2}$ km.

Total distance travelled = $\left(\frac{x}{4} + \frac{x}{2} \right)$ km

$$= \frac{3x}{4} \text{ km}$$

Remaining distance = $\left(x - \frac{3x}{4} \right)$ km = $\frac{x}{4}$ km

It is given that, last
last 30 min, he travelled = 80 km

$$\Rightarrow \frac{x}{4} = 80$$

$$x = 320 \text{ km.}$$

57. (b) As, $7 + 3 = 421 = (7 - 3)(7 \times 3)$
 $11 + 7 = 477 = (11 - 7)(11 \times 7)$
 $9 + 5 = 445 = (9 - 5)(9 \times 5)$
 $6 + 2 = (6 - 2)(6 \times 2) = 412$

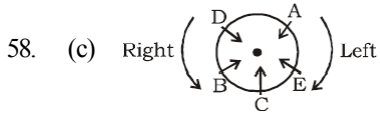

59. (b) Conclusions :
 I. (✓)
 II. (✓)
 III. (✓) } All follow given statements.

60. (d) 61. (c) 62. (c)
 63. (c) 64. (a) 65. (b)
 66. (b) There are 25 numbers in the given sequence.

So, middle number = 13th number = 8.
 Clearly, the third number to the left of this 8 is 2.

67. (d) Coding for:

I	D	E	A	S
-1↓	+1↓	-1↓	+1↓	-1↓
H	E	D	B	R

 Coding for:

W	O	U	L	D
-1↓	+1↓	-1↓	+1↓	-1↓
V	P	T	M	C

 Similarly,

R	I	G	H	T
-1↓	+1↓	-1↓	+1↓	-1↓
Q	J	F	I	S

68. (b) Cancelling every second letter after reversing the alphabet the series becomes. Z X V T R P N L J H F D B
 The middle letter is N.

69. (b) Total no. of girls = $17 + 10 - 1$ or $18 + 9 - 1 = 26$.
 70. (b) From first 2 sentences 'Ka Ya' means 'very intelligent'.
 From 1st and 3rd sentences 'Pu' means 'you'
 \therefore In first sentence 'are' means 'Bi'

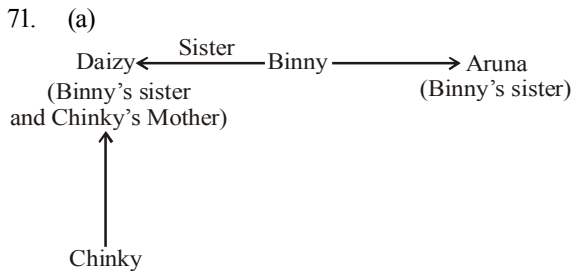

It is clearly shown from the above diagram that Chinky is niece to Aruna.

72. (d) 1st of month was Tuesday, hence the date on first Saturday was 5th.
 Hence, the other Saturdays of the month are 12, 19, 26. Rama met her brother on 26th.

73. (a)

5	3	1	6	9	7
---	---	---	---	---	---

 $576 = 24 \times 24$
 \therefore 4 will be the second digit of the two even number.

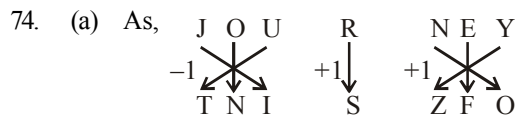

Similarly,

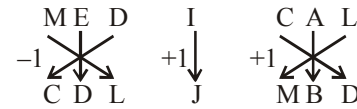

75. (b) $40 \text{ B } 8 \text{ T } 6 \text{ M } 3 \text{ K } 4 = ?$
 $\Rightarrow ? = 40 + 8 - 6 + 3 \times 4$
 $\Rightarrow ? = 5 + 6 - 12 = 11$

76. (a) Here, none of the condition is applied, so the coding is done as follows.

H	U	B	D	I	N
↓	↓	↓	↓	↓	↓
©	6	2	8	9	3

77. (d) Here, none of the condition is applied, so the coding is done as follows.

N	A	B	A	Q	E
↓	↓	↓	↓	↓	↓
3	\$	2	\$	4	#

 \therefore Code for NABAQE \Rightarrow 3\$2\$4#

78. (d) When no condition is applied, the coding is done as follows.

F	W	Z	E	R	A
↓	↓	↓	↓	↓	↓
5	D	1	#	7	\$

But here the second and third letters are consonants, therefore condition (iii) is applied here. As condition (iii) is applied here, both the second and third letters are to be coded as the code for the third letter.

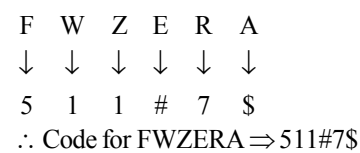

Solutions : (Qs. 79-80)

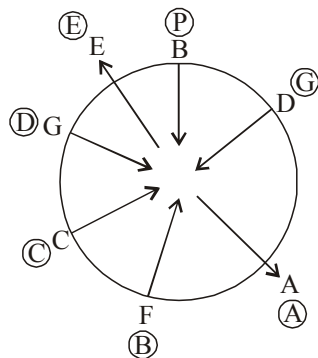

A and E is not facing centre. Rest of all facing centre.

79. (c) A and E person facing opposite to centre.
 80. (d) B, because A is facing opposite to centre.
 81. (a) 82. (a) 83. (c) 84. (c)
 85. (b) 86. (d) 87. (a)
 88. (d) Arihant is a Nuclear powered ballistic missile submarine.
 89. (c) Option (c) is not in the list of principles of panchsheel.
 This agreement stated the five principles as:
1. Mutual respect for each other's territorial integrity and sovereignty.
 2. Mutual non-aggression.
 3. Mutual non-interference in each other's internal affairs.
 4. Equality and cooperation for mutual benefit.
 5. Peaceful co-existence.

90. (b)
 91. (b) Emperor Akbar named Prayag as Allahabad - City of God- also called Allahabad in 1575 AD. The city of Allahabad is situated at the confluence of three rivers - Ganga, Yamuna and the invisible Saraswati. Every 12th year when the waters are felt to be especially purifying, Allahabad holds a much greater festival called Kumbh Mela. Built by Emperor Akbar in 1583 AD, the Allahbad fort stands on the banks of the

river Yamuna near the confluence site i.e SANGAM.

92. (b) 93. (c) 94. (a)
 95. (d) 96. (a) 97. (a)
 98. (c) This is because the scattering in red light is less than that of yellow colour. The longest visible wavelength is red and the shortest is violet. The wavelength of red light is more than yellow light.
 99. (b)
 100. (a) There are 4 players in a polo team.
 101. (d) Hemophilia is a **hereditary defect**.
 102. (a) In human body, vitamin A is stored in the **liver**.
 103. (b) Odometer is a **measuring instrument for frequency of electromagnetic waves**.
 104. (b) **Methanoic acid** is a colorless, pungent smelling liquid with a boiling point 373.5 K. Due to the presence of aldehyde-like hydrogen, it is powerful reducing agent. It reduces Tollen's reagent and Fehling's solution.
 It is used in **rubber, textile, dyeing, leather and electroplating industries**.
 105. (d) 106. (a) 107. (b) 108. (b) 109. (a)
 110. (a) 111. (b) 112. (d) 113. (c) 114. (c)
 115. (b) 116. (c) 117. (a) 118. (a)
 119. (d) Paytm, Indian e-commerce website Paytm launched it's toll-free number 180018001234 to enable transaction through mobile phones without an internet connection on December 7, 2016. Customers can use basic mobile phones to transact money using this service, before that they need to register with Paytm their mobile number and set a four digit paytm PIN.
 120. (b) Bernard Cazeneuve, The French president, François Hollande, has named Bernard Cazeneuve as the new prime minister of France until a presidential election next May. Cazeneuve, who was interior minister, will replace Manuel Valls, who resigned on December 6, 2016, in a bid to become France's next president.

ARITHMETIC

1. Which is the smallest of the following numbers ?

(a) $\sqrt{7}$ (b) $\frac{1}{\sqrt{7}}$
 (c) $\frac{\sqrt{7}}{7}$ (d) $\frac{1}{7}$

2. If $x^{1/3} + y^{1/3} = z^{1/3}$, then $(x + y - z)^3 + 27xyz$ is equal to?

(a) 3 (b) 0
 (c) 1 (d) 2

3. A bag contains ₹ 216 in the form of one rupee, 50 paise and 25 paise coins in the ratio of 2 : 3 : 4. The number of 50 paise coins is :

(a) 96 (b) 144
 (c) 114 (d) 141

4. In a mixture of 45 litres, the ratio of milk and water is 4 : 1. How much water must be added to make the mixture ratio 3 : 2 ?

(a) 72 litres (b) 24 litres
 (c) 15 litres (d) 1.5 litres

5. A started a business with ₹ 4500 and another person B joined after some period with ₹ 3000. Determine this period after B joined the business if the profit at the end of the year is divided in the ratio 2 : 1

(a) After 3 months (b) After 4 months
 (c) After 6 months (d) After $2\frac{1}{2}$ months

6. A cistern has two taps (which fill it in 12 min and 15 min, respectively) and an exhaust tap. When all three taps are opened together, it takes 20 min to fill the empty cistern. How long will the exhaust tap take to empty it ?

(a) 20 min (b) 16 min
 (c) 12 min (d) 10 min

7. 12 men complete a work in 18 days. Six days after they had started working, 4 men joined them. How many days will all of them take to complete the remaining work ?

(a) 10 days (b) 12 days
 (c) 15 days (d) 9 days

8. A motor boat whose speed is 15 km/h in still water goes 30 km downstream and comes back in four and a half hours. The speed of the stream is :

(a) 46 km/h (b) 6 km/h
 (c) 7 km/h (d) 5 km/h

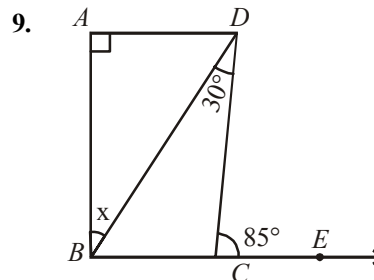

If $AD \parallel BE$, $\angle DCE = 85^\circ$ and $\angle BDC = 30^\circ$, then what is the value of x ?

(a) 30° (b) 35°
 (c) 45° (d) 55°

- 10.

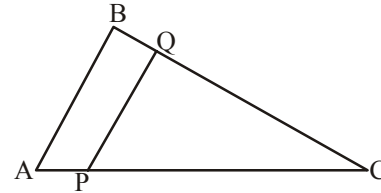

In the given triangle, AB is parallel to PQ . $AP = c$, $PC = b$, $PQ = a$, $AB = x$. What is the value of x ?

(a) $a + \frac{ab}{c}$ (b) $a + \frac{bc}{a}$

(c) $b + \frac{ca}{b}$ (d) $a + \frac{ac}{b}$

11. What is the number of points in the plane of a $\triangle ABC$ which are at equal distance from the vertices of the triangle?

(a) 0 (b) 1
 (c) 2 (d) 3

12. An obtuse angle made by a side of a parallelogram $PQRS$ with other pair of parallel sides is 150° . If the perpendicular distance between these parallel sides (PQ and SR) is 20 cm, what is the length of the side RQ ?

(a) 40 cm (b) 50 cm
 (c) 60 cm (d) 70 cm

13. $ABCD$ is a square. The diagonals AC and BD meet at O . Let K, L be the points on AB such that $AO = AK$ and $BO = BL$. If $\theta = \angle LOK$, then what is the value of $\tan \theta$?

- (a) $1/\sqrt{3}$ (b) $\sqrt{3}$
 (c) 1 (d) $1/2$

14. In the given figure, if $\frac{x}{3} = \frac{y}{4} = \frac{z}{5}$, where $\angle DCQ = x$, $\angle BPC = y$ and $\angle DQC = z$, then what are the values of x, y and z , respectively?

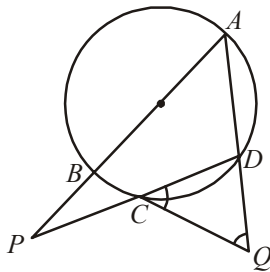

- (a) $33^\circ, 44^\circ$ and 55° (b) $36^\circ, 48^\circ$ and 60°
 (c) $39^\circ, 52^\circ$ and 65° (d) $42^\circ, 56^\circ$ and 70°

15. For what value of k , will the expression $3x^3 - kx^2$

$+ 4x + 16$ be divisible by $\left(x - \frac{k}{2}\right)$?

- (a) 4 (b) -4
 (c) 2 (d) 0

16. a, b, c and d are four consecutive numbers. If the sum of a and d is 103, what is the product of b and c ?

- (a) 2652 (b) 2562
 (c) 2970 (d) 2550

17. If the HCF of $x^3 + mx^2 - x + 2m$ and $x^2 + mx - 2$ is a linear polynomial, then what is the value of m ?

- (a) 1 (b) 2
 (c) 3 (d) 4

18. If mean of y and $\frac{1}{y}$ is M , then what is the mean

of y^3 and $\frac{1}{y^3}$?

- (a) $\frac{M(M^2 - 3)}{3}$ (b) M^3
 (c) $M^3 - 3$ (d) $M(4M^2 - 3)$

19. If $b \tan \theta = 0$, the value of $\frac{a \sin \theta - b \cos \theta}{a \sin \theta + b \cos \theta}$

- (a) $\frac{a - b}{a^2 + b^2}$ (b) $\frac{a + b}{a^2 + b^2}$
 (c) $\frac{a^2 + b^2}{a^2 - b^2}$ (d) $\frac{a^2 - b^2}{a^2 + b^2}$

20. The highest possible value of $\sin \theta + \cos \theta$ is –

- (a) 1 (b) $\sqrt{2}$
 (c) 2 (d) $\sqrt{3}/2$

21. If $a \cos \theta - b \sin \theta = c$, then what is the value of $a \sin \theta + b \cos \theta$?

- (a) $\pm \sqrt{a^2 + b^2 + c^2}$ (b) $\pm \sqrt{a^2 - b^2 + c^2}$
 (c) $\pm \sqrt{a^2 + b^2 - c^2}$ (d) $\sqrt{b^2 + c^2 - a^2}$

DIRECTIONS (Qs. 22-23): The adjacent histogram shows the average pocket money received by 60 students for a span of one month. Study the diagram and answer the question.

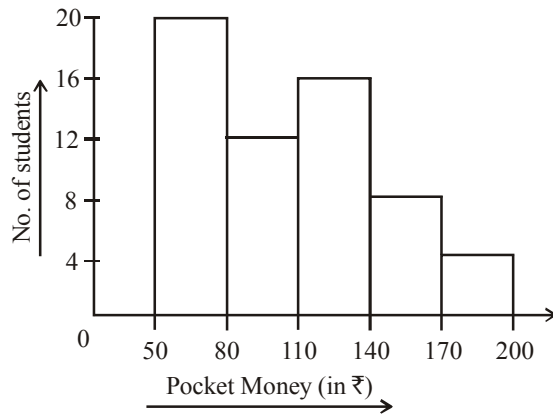

22. Maximum number of students received pocket money between

- (a) 50–80 (b) 140–170
 (c) 80–110 (d) 110–140

23. The number of students who received pocket money upto ₹ 140 is

- (a) 20 (b) 32
 (c) 48 (d) 56

24. Semi-circular lawns are attached to all the edges of a rectangular field measuring 42 m × 35m. The area of the total field is :

- (a) 3818.5 m² (b) 8318 m²
 (c) 5813 m² (d) 1358 m²

25. A steel wire has been bent in the form of a square of area 121 cm². If the same wire is bent in the form of a circle, then the area of the circle will be:

- (a) 130 cm² (b) 136 cm²
 (c) 145 cm² (d) None of these

26. $9^6 - 11$ when divided by 8 would leave a remainder of:
 (a) 0 (b) 1
 (c) 2 (d) 3
27. $\left(\sqrt{\frac{625}{784}} - \sqrt{\frac{16}{49}}\right) \div \sqrt{\frac{81}{144}} = ?$
 (a) $\frac{21}{28}$ (b) $\frac{7}{3}$
 (c) $\frac{3}{7}$ (d) $\frac{27}{112}$
28. The L.C.M. of two number is 630 and their H.C.F. is 9. If the sum of numbers is 153, their difference is
 (a) 17 (b) 23
 (c) 27 (d) 33
29. The average age of the family of five members is 24. If the present age of youngest member is 8 yr, then what was the average age of the family at the time of the birth of the youngest member ?
 (a) 20 yr (b) 16 yr
 (c) 12 yr (d) 18 yr
30. A dishonest dealer professes to sell his goods at cost price, but he uses a weight of 960 g for the kg weight. Find his gain per cent.
 (a) 4% (b) $4\frac{1}{6}\%$
 (c) 96% (d) 40%
31. A and B started a business by investing ₹ 35,000 and ₹ 20,000 respectively. B left the business after 5 months and C joined the business with a sum of ₹ 15,000. The profit earned at the end of the year is ₹ 84,125. What is B's share of profit?
 (a) ₹14133
 (b) ₹15,000
 (c) ₹13,460
 (d) Cannot be determined
32. A, B and C can do a work in 6, 8 and 12 days respectively. Doing that work together they get an amount of ₹ 1350. What is the share of B in that amount?
 (a) ₹ 450 (b) ₹ 168.75
 (c) ₹ 337.50 (d) ₹ 718.75
33. An aeroplane flies along the four sides of a square at the speeds of 200, 400, 600 and 800 km/h. Find the average speed of the plane around the field.
 (a) 384 km/h (b) 370 km/h
 (c) 368 km/h (d) None of these
34. A square carpet with an area 169 m² must have 2 metres cut-off one of its edges in order to be a perfect fit for a rectangular room. What is the area of rectangular room?
 (a) 180 m² (b) 164 m²
 (c) 152 m² (d) 143 m²
35. A man purchases two watches at ₹ 560. He sells one at 15% profit and other at 10% loss. Then he neither gains nor loss. Find the cost price of each watch.
 (a) ₹ 224, ₹ 300 (b) ₹ 200, ₹ 300
 (c) ₹ 224, ₹ 336 (d) ₹ 200, ₹ 336
36. If 6 men and 8 boys can do a piece of work in 10 days while 26 men and 48 boys can do the same in 2 days, the time taken by 15 men and 20 boys in doing the same type of work will be:
 (a) 4 days (b) 5 days
 (c) 6 days (d) 7 days
37. A train running between two stations A and B arrives at its destination 10 minutes late when its speed is 50 km/h and 50 minutes late when its speed is 30 km/h. What is the distance between the stations A and B ?
 (a) 40 km (b) 50 km
 (c) 60 km (d) 70 km
38. If $\frac{3a+5b}{3a-5b} = 5$, then a : b is equal to :
 (a) 2 : 1 (b) 5 : 3
 (c) 3 : 2 (d) 5 : 2
39. $\left(x + \frac{1}{x}\right)\left(x - \frac{1}{x}\right)\left(x^2 + \frac{1}{x^2} - 1\right)\left(x^2 + \frac{1}{x^2} + 1\right)$ is equal to
 (a) $x^6 + \frac{1}{x^6}$ (b) $x^8 + \frac{1}{x^8}$
 (c) $x^8 + \frac{1}{x^8}$ (d) $x^6 - \frac{1}{x^6}$
40. The value of $\tan 4^\circ \cdot \tan 43^\circ \cdot \tan 47^\circ \cdot \tan 86^\circ$ is
 (a) 2 (b) 3
 (c) 1 (d) 4

GENERAL INTELLIGENCE & REASONING

DIRECTIONS (Qs. 41-43) : In questions, select the related word/letters/number from given alternatives.

41. Uttarakhand : Dehradun :: Mizoram : ?
 (a) Aizawl (b) Kohima
 (c) Shillong (d) Darjeeling
42. YQXP : JBIA :: OVNU : ?
 (a) FAGZ (b) HRIS
 (c) DKCJ (d) DNEO
43. 1 : 1 :: 10 : ?
 (a) 12 (b) 110
 (c) 210 (d) 1000

44. The following numbers fall in a group. Which one does not belong to the group?
53, 63, 83, 73
(a) 53 (b) 63
(c) 83 (d) 73
45. Which one is the same as Mumbai, Kolkata and Cochin?
(a) Delhi (b) Kanpur
(c) Chennai (d) Sholapur

DIRECTION (Qs. 46-47): In question, a series is given, with one term missing. Choose the correct alternative from the given ones that will complete the series.

46. CEG, JLN, QSU, ___?
(a) QOS (b) TVY
(c) HJL (d) UVW
47. 285, 253, 221, 189, ?
(a) 150 (b) 182
(c) 157 (d) 156
48. In a certain code language PRESENTATION is written as ENESTAITPRON. How would INTELLIGENCE be written in that code language?
(a) TETGLLTNENCE (b) LLKKTGTTEEBTB
(c) LLENLLTNTETG (d) LLTEIGENINCE
49. A word is given in capital letters. It is followed by four words. Out of these four words, three can not be formed from the letters of the word in capital letters. Point out the word which cannot be formed.
SUPERINTENDENT
(a) DENTIST (b) PERTINENT
(c) TEENER (d) RETENTION

DIRECTIONS (Qs.50) : Which one set of letters when sequentially placed at the gaps in the given letter series shall complete it ?

50. ba _ ba _ _ bbaaa _ bbb _ _ aa
(a) baabab (b) babbaa
(c) baaaab (d) bababa
51. Rakesh ranks 15th from the top and 45th from the bottom in a class. How many students are there in the class?
(a) 64 (b) 59
(c) 54 (d) None of these
52. Moni is daughter of Sheela. Sheela is the wife of my wife's brother. How is Moni related to my wife?
(a) Cousin (b) Niece
(c) Sister (d) Sister-in-law
53. Ram moves from a point X to 20 metres towards North. Then he moves 40 metres towards West. Then he moves 20 metres North. Then he moves 40 metres towards East and then 10 metres towards right and he reaches to a point Y. Find the distance and direction of Y from X ?

- (a) 30 metres, North (b) 30 metres, South
(c) 40 metres, North (d) 40 metres, South
54. Which figure represents the relation among Currency, Rupee and Dollar ?

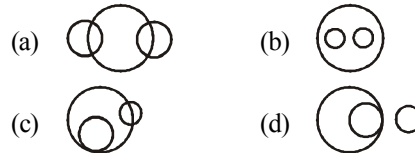

DIRECTIONS (Qs. 55-56) : In questions, find the missing number from the given responses.

55.

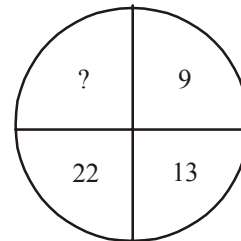

- (a) 40 (b) 38
(c) 39 (d) 44

56.

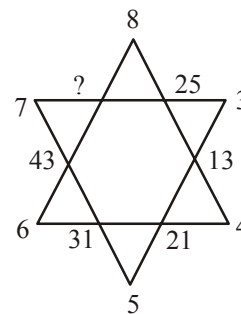

- (a) 56 (b) 57
(c) 58 (d) 59

57. Nitin's age was equal to square of some number last year and the following year it would be cube of a number. If again Nitin's age has to be equal to the cube of some number, then for how long he will have to wait?
(a) 10 years (b) 38 years
(c) 39 years (d) 64 years
58. Six persons are sitting in a circle. A is facing B, B is to the right of E and left of C. C is to the left of D. F is to the right of A. Now D exchanges his seat with F and E with B. Who will be sitting to the left of D ?
(a) D (b) E
(c) A (d) B

DIRECTION (Qs. 59): In question, one statement is given, followed by four Arguments, I, II, III and IV. You have to consider the statements to be true, even if they seem to be at variance from commonly known facts. You are to decide which of the given Arguments can definitely be drawn from the given statement(s). Indicate your answer.

59. Statement:

Should little children be loaded with such heavy school bags?

Arguments:

- I. Yes, heavy bag means more knowledge.
 - II. No, heavy school bags spoil the posture of the children.
 - III. Yes, children need to be adapted for earning knowledge.
 - IV. No, a heavy bag never ensures knowledge gathering.
- (a) I and III appear to be strong arguments.
 (b) I and III are poor arguments
 (c) II and IV are strong arguments
 (d) I and IV are strong arguments

DIRECTION (Qs. 60) : In question, which answer figure will complete the pattern in the question figure?

60. Question figure :

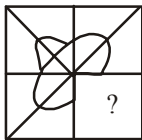

Answer Figures :

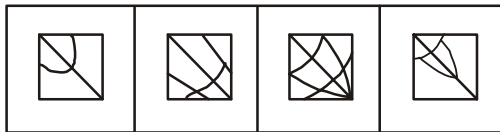

61. Four different positions of dice are as shown below. What number is opposite to face 3 ?

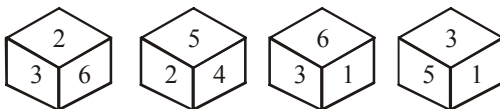

- (a) 4 (b) 3
 (c) 2 (d) 6

DIRECTIONS (62-63) : In each of the following questions, which answer figure will complete the question figure?

62. Question Figure:

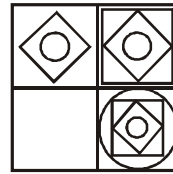

Answer Figures:

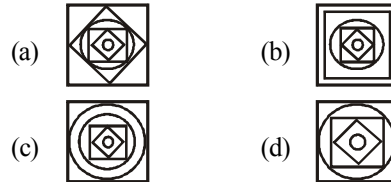

63. Question Figure :

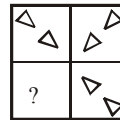

Answer Figures:

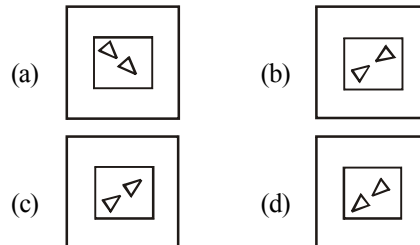

DIRECTIONS (Qs. 64) : In the following questions, select the answer figure in which the question figure is hidden/embedded.

64. Question Figure:



Answer Figures :

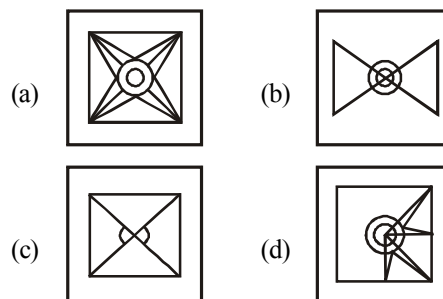

65. A word is represented by only one set of numbers as given in anyone of the alternatives. The sets of numbers given in the alternatives are represented by two classes of alphabets as in the two matrices given below. The columns and rows of matrix I are numbered from 0 to 4 and that of matrix II numbered from 5 to 9. A letter from these matrices can be represented first by its row and next by its column e.g., 'C' can be represented by 00, 12, 23, etc. and 'M' can be represented by 56, 67, 77, etc. Similarly, you have to identify the set for the given word - GOD.

Matrix-I

	0	1	2	3	4
0	C	D	E	F	G
1	G	D	C	G	E
2	E	F	G	C	D
3	G	C	F	D	E
4	D	C	F	G	E

Matrix-II

	5	6	7	8	9
5	L	M	N	O	P
6	O	L	M	N	P
7	L	O	M	P	N
8	N	O	P	M	L
9	P	L	M	N	O

- (a) 10, 11, 65 (b) 95, 79, 12
(c) 30, 65, 40 (d) 00, 10, 75
66. If the following series is written in the reverse order, which number will be fourth to the right of the seventh number from the left?
7, 3, 9, 7, 0, 3, 8, 4, 6, 2, 1, 0, 5, 11, 13
(a) 0 (b) 5
(c) 9 (d) 11
67. In a certain code language 'ne ri so' means 'good rainy day', 'si ne po' means 'day is wonderful' and 'ri jo' means 'good boy'. Which of the following means 'rainy' in the code?
(a) ne (b) si
(c) ri (d) so
68. If SMOOTH is coded as 135579, ROUGH as 97531 and HARD as 9498, then SOFT will be coded as
(a) 1527 (b) 1347
(c) 4998 (d) 8949
69. Saroj is mother-in-law of Vani who is sister-in-law of Deepak. Rajesh is father of Ramesh, the only brother of Deepak. How is Saroj related to Deepak?

- (a) Mother-in-law (b) Wife
(c) Aunt (d) Mother

70. A directional post is erected on a crossing. In an accident, it was turned in such a way that the arrow which was first showing east is now showing south. A passerby went in a wrong direction thinking it is west. In which direction is he actually travelling now?
(a) North (b) South
(c) East (d) West

DIRECTIONS (Qs. 71-72) : Study the following information to answer the given questions.

P, Q, R, S, T, V, X and Y are seated in a straight line facing North, P sits fourth to the left of V. V sits either sixth from the left end of the line or fourth from the right end of the line. S sits second to right of R. R is not an immediate neighbour of V. T and Q are immediate neighbours of each other but neither T nor Q sits at extreme ends of the line. Only one person sits between T and X. X does not sit at the extreme end of the line.

71. What is the position of Q with respect to P?
(a) Fifth to the right
(b) Immediate neighbour
(c) Second to right
(d) Third to left
72. Which of the following represents persons seated at the two extreme ends of the line?
(a) P, V (b) Y, S
(c) R, V (d) R, Y

DIRECTIONS (Qs. 73-75) : Each of the following questions is based on the diagram given below. Study the diagram carefully and answer the questions.

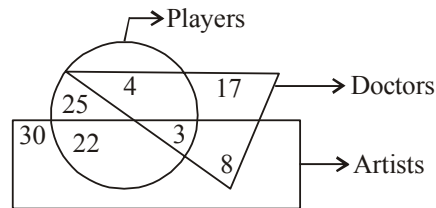

In the above diagram, rectangle represents 'artists', circle represents 'players' and triangle represents 'doctors'.

73. How many players are neither artists nor doctors?
(a) 25 (b) 22 (c) 4 (d) 29
74. How many artists are players?
(a) 22 (b) 3 (c) 25 (d) 8
75. How many artists are neither doctors nor players?
(a) 22 (b) 8
(c) 25 (d) 30

DIRECTIONS (Qs. 76-77): Study the following sequence carefully and answer the questions given below:

ME5PB2A7KN9TRU46IJDF1Q3W8VISZ

76. How many such numbers are there in the above sequence, each of which is both immediately preceded by and immediately followed by a consonant ?
 (a) None (b) One
 (c) Two (d) More than three
77. If the order of the first twenty letters/numbers in the above sequence is reversed and the remaining letters/numbers are kept unchanged, which of the following will be the fourteenth letter/number from the right end after the rearrangement?
 (a) B (b) 6 (c) 2 (d) 1

DIRECTIONS (Qs. 78-80) : Study the following information to answer the given questions.

Eight friends, A, B, C, D, E, F, G and H are sitting in a circle facing the centre, not necessarily in the same order. D sits third to the left of A. E sits to the immediate right of A. B is third to the left of D. G is second to the right of B. C is an immediate neighbour of B. C is third to the left of H.

78. Who amongst the following is sitting exactly between F and D ?
 (a) C (b) E (c) H (d) A
79. Three of the following four are alike in a certain way based on the information given above and so form a group. Which is the one that does not belong to that group ?
 (a) DC (b) AH (c) EF (d) CB
80. Who amongst the following is sitting second to the left of H?
 (a) E (b) B
 (c) A (d) None of these

GENERAL AWARENESS

81. Which Article of the Indian Constitution guarantees rights to arrested persons ?
 (a) Article 22 (b) Article 35
 (c) Article 20 (d) Article 42
82. For a person having hypermetropia, the near point is
 (a) Greater than 20 cm (b) Lesser than 25cm
 (c) Greater than 25cm (d) Lesser than 30cm
83. Cryogenic is a science deals with
 (a) High Temperatures (b) Low Pressure
 (c) High Pressure (d) Low Temperature
84. is an active factor of production
 (a) Product (b) Labour
 (c) Wages (d) Price
85. When total utility becomes maximum, then marginal utility will be
 (a) Maximum
 (b) Minimum
 (c) Either maximum or minimum
 (d) Zero
86. Revealed Preference Theory was propounded by
 (a) Robbins (b) Smith
 (c) Samuelson (d) Schumpeter
87. One Carat of diamond is equal to
 (a) 200m (b) 100m
 (c) 150m (d) 300m
88. Wood Spirit is which of the following ?
 (a) Ethyl Alcohol (b) Propanol
 (c) Methyl Alcohol (d) Butanol
89. Which of the following is chief source of Naphthalene ?
 (a) Moth balls (b) Mothflakes
 (c) Tar Camphor (d) Coal tar
90. Study of crop production is
 (a) Entology (b) Ecology
 (c) Botany (d) Agronomy
91. Who was the last guru of the Sikhs ?
 (a) Guru Granth Sahib
 (b) Guru Gobind Singh
 (c) Guru Angad
 (d) Guru Amar Das
92. Tattvabodhini Sabha was founded by in 1839
 (a) Swami Vivekanand
 (b) Keshav Chandra Sen
 (c) Dabendranath Tagore
 (d) Swami Sahajanand
93. After the revolt of 1857, British pursued the policy of
 (a) Divide and Policies
 (b) Rules and Regulation
 (c) Divide and Rule
 (d) Unity and Poliy
94. Prithvi-I missile was inducted into the in 1994
 (a) Indian Army (b) Indian Air Force
 (c) Indian Navy (d) All of these
95. 2018 FIFA World Cup to be held in
 (a) China (b) Russia
 (c) India (d) Brazil
96. is issued by the court in case of illegal detention of a person
 (a) Quo Warranto (b) Habeas Corpus
 (c) Mandamus (d) Certiorari
97. At the time of Emergency, the Indian State become unitary from
 (a) Semi Federal (b) Federal
 (c) Unitary (d) Quasi-federal

98. The book titled 'The Life and Death of Adolf Hitler' is penned by
 (a) Z.A. Bhutto (b) James Cross Giblin
 (c) J.M. Barrie (d) Gunnar Myrdal
99. Bos Taurus is a scientific name of.....
 (a) Buffalo (b) Horse
 (c) Cow (d) Cat
100. includes all prokaryotic organism likes bacteria, cyanobacteria and archiobacteria
 (a) Animalia (b) Protista
 (c) Monera (d) Planatae
101. is the Kuchipudi dancer
 (a) Anupama Mohan (b) Bimbavati Devi
 (c) Arush Mudgal (d) Swapnasundari
102. Which of the following is not a chief organ of the United Nations Organisations?
 (a) International Labour Organisation
 (b) Security Council
 (c) International Court of Justice
 (d) General Assembly
103. The treaty of Mangalore was signed between
 (a) the English East India Company and Haidar Ali
 (b) the English East India Company and Tipu Sultan
 (c) Haidar Ali and the Zamorin of Calicut
 (d) the French East India Company and Tipu Sultan
104. World's largest Charkha (spinning wheels) that was unveiled at Terminal 3 of the Indira Gandhi International Airport (IGI), New Delhi is made of the teak wood of which country?
 (a) Burma (b) Sri Lanka
 (c) Nepal (d) Ukraine
105. The Union Cabinet recently approved The High Courts (Alteration of Names) Bill, 2016 to be introduced in the Parliament. The bill will facilitate the changing of the names of which two high courts?
 (a) Bombay High Court and Calcutta High Court
 (b) Bombay High Court and Madras High Court
 (c) Calcutta High Court and Madras High Court
 (d) Bombay High Court and Gauhati High Court
106. Linux is an example of.....
 (a) Freeware
 (b) Open source software
 (c) Shareware
 (d) Complimentary
107. A is used to read handwritten or printed text to make a digital image that is stored in memory.
 (a) Printer (b) Laser beam
 (c) Scanner (d) Touchpad
108. You organize files by storing them in
 (a) Archives (b) Lists
 (c) Indexes (d) Folders
109. What is the default file extension for all Word documents?
 (a) WRD (b) TXT
 (c) DOC (d) FIL
110. A device that connects to a network without the use of cables is said to be
 (a) Distributed (b) Non-Wired
 (c) Centralized (d) Wireless
111. In which of the following cities are located 3 zonal headquarters of Indian Railways?
 (a) Guwahati (b) Mumbai
 (c) New Delhi (d) Kolkata
112. Who of the following is known for having designed the first railway timetables?
 (a) George Bradman
 (b) George Bernard Shaw
 (c) George Bradshaw
 (d) George Brummel
113. Which of the following is the largest railway junction in India?
 (a) Delhi (b) Bhatinda
 (c) Mathura (d) Allahabad
114. Which of the following is the eastern-most division of the Indian Railways?
 (a) Tinsukia (b) Lumding
 (c) Rangiya (d) Katihar
115. Over which of the following rivers is the world's highest railway bridge in Kashmir being constructed?
 (a) Chenab (b) Jhelum
 (c) Sutlej (d) Indus
116. Which country won the women's Hockey Junior World Cup 2016 held in Santiago, Chile?
 (a) Netherland (b) Argentina
 (c) Russia (d) Sweden
117. When is the International Civil Aviation Day observed?
 (a) December 5 (b) December 7
 (c) December 8 (d) December 6
118. Who was sworn-in as the Chief Minister of Tamil Nadu in December 2016?
 (a) E Madhusootheran
 (b) O Panneerselvam
 (c) Sasikala
 (d) Edappadi K Palaniswami
119. Who won the 2016 Women's Asia Cup T20?
 (a) India (b) Pakistan
 (c) Bangladesh (d) None of the above
120. Which nation's Prime Minister announced his surprise resignation on 5 December 2016, saying it is the right time to leave politics?
 (a) Italy (b) New Zealand
 (c) Spain (d) France

Hints & Explanations

1. (d) Clearly, $\frac{1}{7} < \frac{1}{\sqrt{7}} = \frac{\sqrt{7}}{7} < \sqrt{7}$
 $\Rightarrow \frac{1}{7}$ is the smallest number.
2. (b) The given equation = $x^{1/3} + y^{1/3} = z^{1/3}$
 cubing both sides
 $(x^{1/3} + y^{1/3})^3 = z$
 $\Rightarrow x + y + 3(x^{2/3})(y^{1/3}) + 3(x^{1/3})(y^{2/3}) = z$
 $\Rightarrow x + y + 3[(x^{2/3})(y^{1/3}) + (x^{1/3})(y^{2/3})] = z$
 $\Rightarrow x + y + 3(x^{1/3})(y^{1/3})(x^{1/3} + y^{1/3}) = z$
 putting $x^{1/3} + y^{1/3} = z^{1/3}$
 $\Rightarrow x + y + 3(x^{1/3})(y^{1/3})(z^{1/3}) = z$
 $\Rightarrow x + y - z = -3(x^{1/3})(y^{1/3})(z^{1/3})$
 $\Rightarrow (x + y - z)^3 = -3(x^{1/3})(y^{1/3})(z^{1/3})^3$
 $\Rightarrow (x + y - z)^3 = -27xyz$ (cubing both sides)
 $\Rightarrow (x + y - z)^3 = +27xyz = 0$
3. (b) Let the no. of rupee, 50 paise and 25 paise coins be $2x$, $3x$ and $4x$ respectively.
 According to question,
 $\text{₹} \left(2x + \frac{3x}{2} + \frac{4x}{4} \right) = \text{Rs. } 216$
 $\Rightarrow \frac{8x + 6x + 4x}{4} = 216$
 $\therefore x = 48$
 \therefore Number of 50 paise coins = $48 \times 3 = 144$
4. (c) Quantity of milk = $45 \times \frac{4}{5} = 36$ litres
 Quantity of water = $45 \times \frac{1}{5} = 9$ litres
 Let x litres of water be added to make the ratio 3 : 2
 Then, $\frac{36}{9+x} = \frac{3}{2}$
 $\Rightarrow 72 = 27 + 3x \Rightarrow x = 15$ litres
5. (a) Let B joined after x months.
 Then, $4500 \times 12 : 3000(12 - x) = 2 : 1$
 Ratio of their investments
 $= \frac{4500 \times 12}{3000(12 - x)} = \frac{2}{1}$
 $\Rightarrow x = 3$

6. (d) Let the exhaust tap empties the tank in x minutes.

$$\text{Then, } \frac{1}{12} + \frac{1}{15} - \frac{1}{x} = \frac{1}{20} \text{ or}$$

$$\frac{1}{x} = \frac{1}{12} + \frac{1}{15} - \frac{1}{20}$$

$$\text{or } \frac{1}{x} = \frac{5+4-3}{60} = \frac{6}{60} = \frac{1}{10} \text{ or } x = 10 \text{ min}$$

7. (d) In 1 day, work done by 12 men = $\frac{1}{18}$

$$\text{In 6 days, work done by 12 men} = \frac{6}{18} = \frac{1}{3}$$

$$\text{Remaining work} = \frac{2}{3}$$

$$\text{Now, } m_1 \times d_1 \times w_2 = m_2 \times d_2 \times w_1$$

$$\text{or } 12 \times 18 \times \frac{2}{3} = 16 \times d_2 \times 1$$

$$\text{or } d_2 = \frac{4 \times 18 \times 2}{16} = 9 \text{ days}$$

8. (d) Let the speed of the stream be x km/h.
 Then, upstream speed = $(15 - x)$ km/h.
 and downstream speed = $(15 + x)$ km/h.

$$\text{Now, } \frac{30}{(15+x)} + \frac{30}{(15-x)} = 4.5$$

Solving these equations, we get $x = 5$ km/h.

9. (b) $AD \parallel BE$
 $\therefore \angle ADC = \angle DCE$ (alternate angles)
 $\Rightarrow \angle ADB + 30^\circ = 85^\circ$
 $\Rightarrow \angle ADB = 55^\circ$
 and $\angle BAD = 90^\circ$ (given)
 Now, in $\triangle ABD$,
 $\angle ABD + \angle ADB + \angle BAD = 180^\circ$
 $\Rightarrow x + 55^\circ + 90^\circ = 180^\circ$
 $\Rightarrow x = 180^\circ - 145^\circ = 35^\circ$

10. (d) In $\triangle ABC$ and $\triangle PQC$,

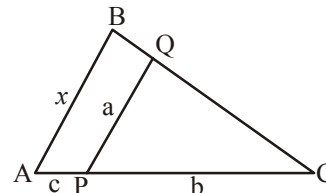

$$\therefore \frac{PC}{AC} = \frac{PQ}{AB}$$

$$\Rightarrow \frac{b}{c+b} = \frac{a}{x}$$

$$\therefore x = \frac{a(c+b)}{b} = \frac{ac}{b} + a$$

11. (b) Number of points is one, because circumcentre is the only point in the plane of a triangle, which is equidistant from the vertices of the triangle.

$$OA = OB = OC = r$$

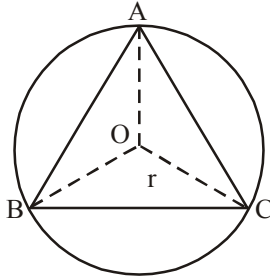

12. (a) Given that, $\angle SPQ = 150^\circ$ and $PM = 20$ cm

In parallelogram PQRS,
 $\angle RSP + \angle SPQ = 180^\circ$ (interior angles)
 $\angle RSP = 180^\circ - 150^\circ = 30^\circ$
 $\Rightarrow \angle RSP = \theta = 30^\circ$

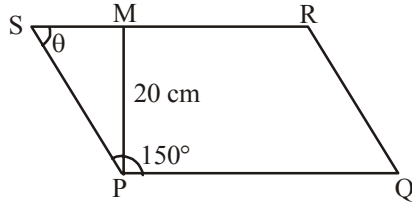

In $\triangle PSM$,

$$\sin \theta = \sin 30^\circ = \frac{PM}{SP}$$

$$\Rightarrow \frac{1}{2} = \frac{20}{SP} \Rightarrow SP = 40 \text{ cm}$$

$$\therefore RQ = SP = 40 \text{ cm.}$$

13. (c) Let sides of the square be a.

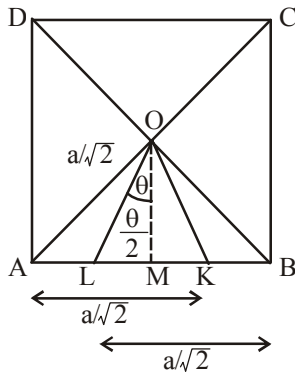

Then, $AC = a\sqrt{2}$ and $AO = OC = \frac{a}{\sqrt{2}}$

Here, $AM = \frac{a}{2}$

$$\therefore LM = \frac{a}{\sqrt{2}} - \frac{a}{2} \text{ and } OM = \frac{a}{2}$$

$$\text{In } \triangle OML, \tan \frac{\theta}{2} = \frac{\frac{a}{\sqrt{2}} - \frac{a}{2}}{\frac{a}{2}} = \frac{\sqrt{2}-1}{1}$$

$$= \sqrt{2}-1$$

$$\therefore \tan \theta = \frac{2 \tan \frac{\theta}{2}}{1 - \tan^2 \frac{\theta}{2}} = \frac{2(\sqrt{2}-1)}{1 - (2+1-2\sqrt{2})}$$

$$= \frac{2(\sqrt{2}-1)}{1-3+2\sqrt{2}} = \frac{2(\sqrt{2}-1)}{2\sqrt{2}-2}$$

$$\Rightarrow \tan \theta = 1$$

14. (b) Given $\frac{x}{3} = \frac{y}{4} = \frac{z}{5} = \alpha$ (say)

$$\therefore x = 3\alpha, y = 4\alpha \text{ and } z = 5\alpha$$

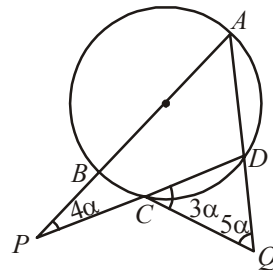

Since, $\angle DCQ = \angle BCP = 3\alpha$

(vertically opposite angle)

In $\triangle DCQ$, $\angle CDQ = 180^\circ - (3\alpha + 5\alpha) = 180^\circ - 8\alpha$ by

proportion of cyclic quadrilateral,

$$\angle QDC = \angle CBA = 180^\circ - 8\alpha$$

$$\Rightarrow \angle PBC = 8\alpha$$

In $\triangle PBC$,

$$\angle P + \angle B + \angle C = 180^\circ$$

$$\therefore 4\alpha + 8\alpha + 3\alpha = 180^\circ$$

$$\Rightarrow \alpha = \frac{180^\circ}{15} \Rightarrow \alpha = 12^\circ$$

$$\therefore x = 36^\circ, y = 48^\circ, z = 60^\circ$$

15. (b) The expression $3x^3 - kx^2 + 4x + 16$ is divisible by $x - \frac{k}{2}$.

Then, $x = \frac{k}{2}$ satisfy the equation

$$\Rightarrow 3\left(\frac{k}{2}\right)^3 - k\left(\frac{k}{2}\right)^2 + 4\left(\frac{k}{2}\right) + 16 = 0$$

$$\Rightarrow \frac{3k^3 - 2k^3 + 16k + 128}{8} = 0$$

$$\Rightarrow k^3 + 16k + 128 = 0$$

$$\Rightarrow (k+4)(k^2 - 4k + 32) = 0$$

$$\Rightarrow k+4 = 0$$

$$\Rightarrow k = -4$$

16. (a) Here $d = a + 3$
 $a + a + 3 = 103$
 $2a = 100$
 $a = 50$

So, numbers are 50, 51, 52 and 53

$$\therefore b \times c = 51 \times 52 = 2652$$

17. (a) Let $f_1(x) = x^3 + mx^2 - x + 2m$
and $f_2(x) = x^2 + mx - 2$
Let $m = 1$

$$\therefore f_1(x) = x^3 + x^2 - x + 2$$

$$\text{and } f_2(x) = x^2 + x - 2 = (x+2)(x-1)$$

When $x = 1$,

$$f(1) = 1 + 1 - 1 + 2 \neq 0$$

When $x = -2$,

$$f(-2) = (-2)^3 + (-2)^2 - (-2) + 2 = 0$$

Required value of m is 1.

18. (d) Mean of y and $\frac{1}{y} = M$

$$\Rightarrow \frac{y + \frac{1}{y}}{2} = M \Rightarrow y + \frac{1}{y} = 2M \quad \dots (i)$$

Now, mean of y^3 and $\frac{1}{y^3}$ is

$$\frac{y^3 + \frac{1}{y^3}}{2} = \frac{\left(y + \frac{1}{y}\right)^3 - 3\left(y + \frac{1}{y}\right)}{2}$$

$$\Rightarrow \frac{y^3 + \frac{1}{y^3}}{2} = \frac{(2M)^3 - 6M}{2}$$

$$= \frac{(2M)\left[(2M)^2 - 3\right]}{2} = M(4M^2 - 3)$$

19. (b) $\tan \theta = \frac{a}{b}$

$$\frac{a \sin \theta - b \cos \theta}{a \sin \theta + b \cos \theta} = \frac{a \tan \theta - b}{a \tan \theta + b}$$

$$= \frac{a \times \frac{a}{b} - b}{a \times \frac{a}{b} + b} = \frac{a^2 - b^2}{a^2 + b^2}$$

20. (b) Let $y = \sin \theta + \cos \theta$

$$\therefore \frac{dy}{d\theta} = \cos \theta - \sin \theta, y \text{ is maximum when}$$

$$\frac{dy}{dx} = 0$$

$$\cos \theta = \sin \theta \Rightarrow \theta = 45^\circ$$

$$\therefore \text{maximum } y = \sin 45^\circ + \cos 45^\circ$$

$$= \frac{1}{\sqrt{2}} + \frac{1}{\sqrt{2}} = \frac{2}{\sqrt{2}} = \sqrt{2}$$

21. (c) Given, $a \cos \theta - b \sin \theta = c$

On squaring both sides, we get

$$a^2 \cos^2 \theta + b^2 \sin^2 \theta - 2ab \cos \theta \sin \theta = c^2$$

$$\Rightarrow a^2 (1 - \sin^2 \theta) + b^2 (1 - \cos^2 \theta) - 2ab \sin \theta \cos \theta = c^2$$

$$\Rightarrow a^2 + b^2 - c^2 = a^2 \sin^2 \theta + b^2 \cos^2 \theta + 2ab \sin \theta \cos \theta$$

$$\Rightarrow (a \sin \theta + b \cos \theta)^2 = a^2 + b^2 - c^2$$

$$\Rightarrow a \sin \theta + b \cos \theta = \pm \sqrt{a^2 + b^2 - c^2}$$

22. (a)

23. (c) $20 + 12 + 16 = 48$

24. (a) Area of the field = Area of rectangle + Area of circle with diameter 35 m + Area of circle with diameter 42 m.

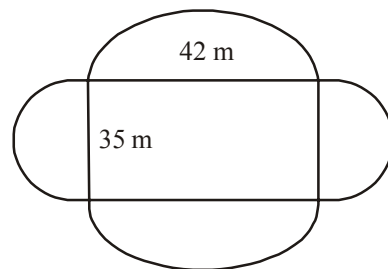

$$= 42 \times 35 + 2 \times \frac{1}{2} \times \frac{22}{7} \times (21)^2 + 2 \times \frac{1}{2} \times \frac{22}{7} \times (17.5)^2$$

$$= 1470 + 1386 + 962.5 = 3818.5 \text{ m}^2$$

25. (d) Perimeter of the square = circumference of the circle

$$\text{We have, } 4 \times 11 = 2\pi r \Rightarrow r = \frac{4 \times 11}{2 \times \pi}$$

$$\text{Area of the circle} = \pi r^2$$

$$= \pi \times \left(\frac{4 \times 11}{2 \times \pi} \right)^2 = 49\pi$$

$$= 154 \text{ cm}^2$$

26. (c) When $9^6 - 1$ is divided by 8, the remainder is zero.
 $\therefore 9^6 - 11$ is divided by 8, the remainder is $1 + 1 = 2$.

27. (c) $\left(\sqrt{\frac{625}{784}} - \sqrt{\frac{16}{49}} \right) = \frac{\sqrt{625}}{\sqrt{784}} - \frac{\sqrt{16}}{\sqrt{49}} = \frac{25}{28} - \frac{4}{7} = \frac{9}{28}$

$$\sqrt{\frac{81}{144}} = \frac{\sqrt{81}}{\sqrt{144}} = \frac{9}{12} = \frac{3}{4}$$

$$\text{Hence, } ? = \frac{9}{28} \div \frac{3}{4} = \frac{9}{28} \times \frac{4}{3} = \frac{3}{7}$$

28. (c) Let numbers be x and y .
 \therefore Product of two numbers = their (LCM \times HCF)

$$\Rightarrow xy = 630 \times 9$$

$$\text{Also, } x + y = 153 \text{ (given)}$$

$$\text{since } x - y = \sqrt{(x + y)^2 - 4xy}$$

$$\Rightarrow x - y = \sqrt{(153)^2 - 4(630 \times 9)}$$

$$= \sqrt{23409 - 22680} = \sqrt{729} = 27$$

29. (b) Total age of the family of five members = $24 \times 5 = 120$

$$\begin{aligned} \text{Total age of the family of five members} \\ \text{before 8 years} \\ = 120 - 5 \times 8 = 120 - 40 = 80 \end{aligned}$$

$$\text{So, Required average age} = \frac{80}{5} = 16 \text{ yr}$$

30. (b) Error = $1 \text{ kg} - 960 \text{ g}$
 $= 1000 \text{ g} - 960 \text{ g} = 40 \text{ g}$.

$$\therefore \text{Gain \%} = \frac{40}{1000 - 40} \times 100$$

$$= \frac{40}{960} \times 100 = 4 \frac{1}{6} \%$$

31. (c) Ratio of equivalent capitals of A, B and C for 1 month

$$\begin{aligned} &= 35000 \times 12 : 20000 \times 5 : 15000 \times 7 \\ &= 35 \times 12 : 20 \times 5 : 15 \times 7 = 84 : 20 : 21 \end{aligned}$$

$$\text{Sum of the ratios} = 84 + 20 + 21 = 125$$

$$\therefore \text{B's share} = ₹ \left(\frac{20}{125} \times 84125 \right) = ₹ 13460$$

32. (a) A's one day's work = $\frac{1}{6}$

$$\text{B's one day's work} = \frac{1}{8}$$

$$\text{C's one day's work} = \frac{1}{12}$$

$$\text{A's share} : \text{B's share} : \text{C's share}$$

$$= \frac{1}{6} : \frac{1}{8} : \frac{1}{12}$$

Multiplying each ratio by the L.C.M. of their denominators, the ratios become 4 : 3 : 2

$$\therefore \text{B's share} = \frac{1350 \times 3}{9} = ₹ 450$$

33. (a) Let each side of the square be x km and let the average speed of the plane around the field be y km/h. Then,

$$\frac{x}{200} + \frac{x}{400} + \frac{x}{600} + \frac{x}{800} = \frac{4x}{y}$$

$$\Rightarrow \frac{25x}{2400} = \frac{4x}{y} \Rightarrow y = \left(\frac{2400 \times 4}{25} \right) = 384.$$

$$\therefore \text{Average speed} = 384 \text{ km/h.}$$

34. (d) Side of square carpet = $\sqrt{\text{Area}}$

$$= \sqrt{169} = 13 \text{ m}$$

After cutting of one side,

$$\text{Measure of one side} = 13 - 2 = 11 \text{ m}$$

and other side = 13 m (remain same)

$$\therefore \text{Area of rectangular room} = 13 \times 11 = 143 \text{ m}^2$$

35. (c) Here, in whole transaction, there is neither gains nor loss, therefore,

Amount of gain in one watch

$$= \text{Amount of loss in other watch}$$

$$\Rightarrow 0.15 \times \text{CP}_1 = 0.10 \times \text{CP}_2$$

$$\Rightarrow \frac{\text{CP}_1}{\text{CP}_2} = \frac{0.10}{0.15} = \frac{2}{3}$$

$$\text{Also } \text{CP}_1 + \text{CP}_2 = 560$$

$$\therefore \text{CP}_1 = \frac{2}{(2+3)} \times 560 = ₹ 224$$

$$\text{and } \text{CP}_2 = 560 - 224 = ₹ 336$$

36. (a) Let 1 man's 1 day's work = x and 1 boy's 1 day's work = y.
 Then, $6x + 8y = \frac{1}{10}$ and $26x + 48y = \frac{1}{2}$.
 Solving these two equations, we get :
 $x = \frac{1}{100}$ and $y = \frac{1}{200}$.
 \therefore (15 men + 20 boys)'s 1 day's work
 $= \left(\frac{15}{100} + \frac{20}{200} \right) = \frac{1}{4}$.
 \therefore 15 men and 20 boys can do the work in 4 days.

37. (b) Let the distance between the two stations be x km.
 Then, $\frac{x}{50} - \frac{10}{6} = \frac{x}{30} - \frac{50}{6}$
 $\Rightarrow \frac{x}{50} - \frac{1}{6} = \frac{x}{30} - \frac{5}{6}$
 or $\frac{x}{30} - \frac{x}{50} = \frac{2}{3}$ or $x = 50$ km
 Thus distance between the station A and B = 50 km

38. (d) $\frac{3a + 5b}{3a - 5b} = \frac{5}{1}$
 By componendo and dividendo,
 $\frac{3a + 5b + 3a - 5b}{3a + 5b - 3a + 5b} = \frac{5 + 1}{5 - 1}$
 $\Rightarrow \frac{6a}{10b} = \frac{6}{4} \Rightarrow \frac{a}{b} = \frac{6}{4} \times \frac{10}{6} = \frac{5}{2}$

39. (d) $\left(x + \frac{1}{x}\right)\left(x - \frac{1}{x}\right)$
 $\left(x^2 + \frac{1}{x^2} - 1\right)\left(x^2 + \frac{1}{x^2} + 1\right)$
 $= \left(x^2 - \frac{1}{x^2}\right)\left[\left(x^2 + \frac{1}{x^2}\right)^2 - 1\right]$
 $= \left(x^2 - \frac{1}{x^2}\right)\left[\left(x^4 + \frac{1}{x^4} + 2 - 1\right)\right]$
 $= \left(x^2 - \frac{1}{x^2}\right)\left(x^4 + \frac{1}{x^4} + 1\right) = x^6 - \frac{1}{x^6}$

40. (c) $\tan 4^\circ \cdot \tan 43^\circ \cdot \tan 47^\circ \cdot \tan 86^\circ$
 $= \tan 4^\circ \cdot \tan 43^\circ \cdot \tan (90^\circ - 43^\circ) \cdot \tan (90^\circ - 4^\circ)$
 $= \tan 4^\circ \cdot \tan 43^\circ \cdot \cot 43^\circ \cdot \cot 4^\circ = 1$
 [tan (90° - θ) = cot θ; tan θ, cot θ = 1]

41. (a) Dehradun is capital of Uttarakhand. Similarly, Aizawl is capital of Mizoram.

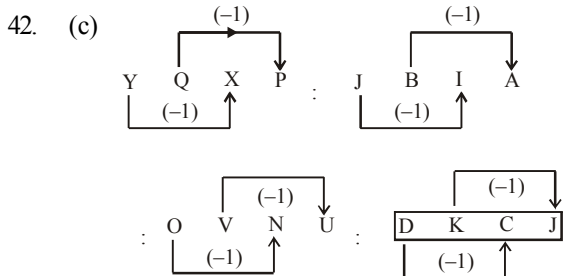

43. (d) As, $(1)^3 : 1$
 Similarly,
 $(10)^3 : 1000$

44. (b) Here, only 63 is not belonging to group because it is divisible by 3.

45. (c) Mumbai, Kolkata and Cochin all are coastal city. Similarly, Chennai is also a coastal city.

46. (c)
 $C \xrightarrow{+2} E \xrightarrow{+2} G \quad J \xrightarrow{+2} L \xrightarrow{+2} N \quad Q \xrightarrow{+2} S \xrightarrow{+2} U$

Similarly, $H \xrightarrow{+2} J \xrightarrow{+2} L$

47. (c) $\begin{matrix} 285 & 253 & 221 & 189 & 157 \\ \hline & -32 & -32 & -32 & -32 \end{matrix}$

48. (d)
 PR ES EN TA TI ON \rightarrow EN ES TA IT PR ON
 1 2 3 4 5 6 \rightarrow 3 2 4 5 1 6
 Similarly,

IN TE LL IG EN CE \rightarrow LL TE IG EN IN CE
 1 2 3 4 5 6 \rightarrow 3 2 4 5 1 6

49. (d) RETENTION

50. (b) ba/ b ba a / b bbaaa/ b bbb a a a

51. (b) Clearly, no. of students in the class = 14+1 + 44 \Rightarrow 59.

52. (b)

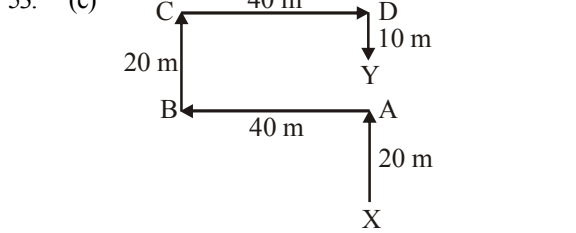

Required distance = XY = AX + AY
 = 20 + 10
 = 30 m, North

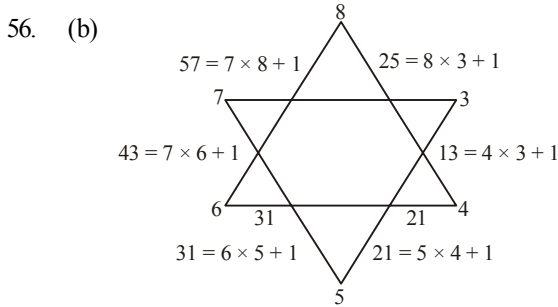
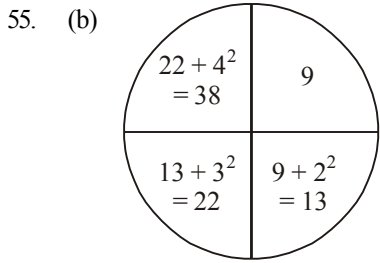
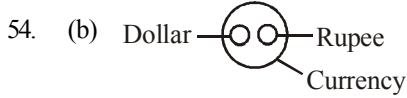

57. (b) Clearly, we have to first find two numbers whose difference is 2 and of which the smaller one is a perfect square and the bigger one a perfect cube. Such numbers are 25 and 27. Thus, Nitin is now 26 years old. Since the next perfect cube after 27 is 64, So required time period = (64 - 26) years = 38 years.

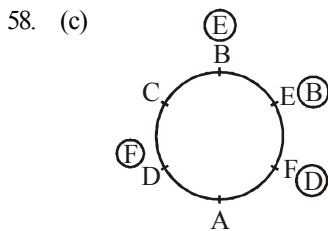

Now, A is to the left of D.
 59. (c) Arguments :
 I. (✗) It does not tell about real meaning.
 II. (✓) Heavy bags spoil the posture of the children.

III. (✗) More load does not mean to get more knowledge

IV. (✓) knowledge can not be gained by taking more load.

60. (d)
 61. (a) The numbers 1, 2, 5 and 6 are on the adjacent faces of the number 3. So, the number 4 lies opposite 3.
 62. (a) 63. (c) 64. (a)
 65. (c) G ⇒ 04, 10, 22, 30, 43
 O ⇒ 58, 65, 76, 86, 99
 D ⇒ 01, 11, 24, 33, 40

Option	G	O	D
(a)	10	11	65
(b)	95	79	12
(c)	30	65	40
(d)	00	10	75

66. (a) The given series when written in the reverse order becomes.
 13, 11, 5, 0, 1, 2, 6, 4, 8, 3, 0, 7, 9, 3, 7
 The 7th number from the left is 6. The 4th number to the right of 6 is 0.

67. (d)
 ne ri so → good rainy day
 si ne po → day is wonderful
 ri jo → good boy

So, the code for rainy is 'so'.

68. (a) As,
 S M O O T H
 ↓ ↓ ↓ ↓ ↓ ↓
 1 3 5 5 7 9
 R O U G H
 ↓ ↓ ↓ ↓ ↓
 9 7 5 3 1
 and
 H A R D
 ↓ ↓ ↓ ↓
 9 4 9 8

It clearly shown that only first option conatins 1527.

So,
 S O F T
 ↓ ↓ ↓ ↓
 1 5 2 7

Thus, the correct code for soft will be 1527.

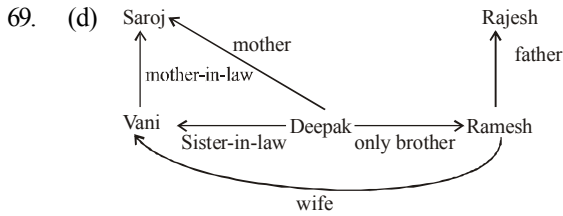

So, it is clear from the above family tree that saroj is Mother to Deepak.

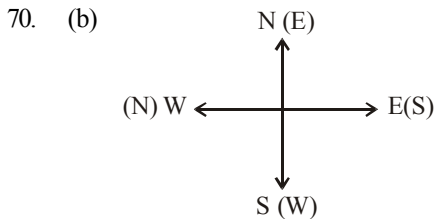

When the arrow turns, East becomes South, North becomes East, West becomes North and South becomes West.

So, the traveller must be actually travelling in the South thinking it is West.

(Q.No. 71–72): On the basis of given information, the final sitting arrangement of eight persons in a straight line facing North is as following

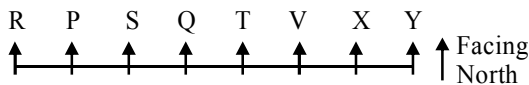

- 71. (c) Q is second to the right of P.
- 72. (d) R and Y are sitting at the two extreme ends of the line.
- 73. (a) There are 25 players who are neither artists nor doctors because this is the only region of the circle which is not common with either rectangle or triangle.
- 74. (c) Required number = 22 + 3 = 25
- 75. (d) There are 30 artists who are neither doctors nor players because this is the only region of the rectangle which is not common with either circle or triangle.
- 76. (d) Four members in the sequence.

ME 5 PB 2 A 7 K N 9 T R U 4 6 I J D F 1 Q 3
 W 8 V I S Z

77. (a) FDJI64URT9NK7A2 **B** P5EM1Q3
 W8VISZ

B 14th from right end.

(Q. Nos 78-80) Arrangement according to the question is as follows

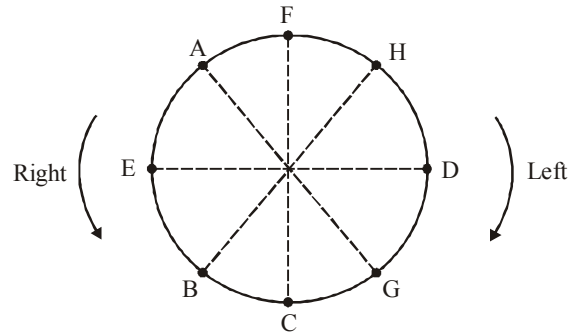

- 78. (c) Clearly, H is sitting exactly between F and D.
- 79. (d) DGC AFH EAF C None B
 ↑ ↑ ↑ ↑
 Skipped Skipped Skipped No Member
 is skipped in between

So, CB does not belong to the group.

- 80. (d) Clearly, G is sitting second to the left of H.
- 81. (a) Article 22 proceeds to guarantee certain fundamental rights to every arrested person.
- 82. (c) Hypermetropia Myopia is corrected by spectacles having concave lens. Near point of a person suffering from hypermetropia is more than 25cm.
- 83. (d) Cryogenics is the study of the production and behaviour of materials at very low temperatures.
- 84. (b) Some of the important factors of production are: (i) Land (ii) Labour (iii) Capital (iv) Enterprnuer. Land is a passive factor whereas labour is an active factor of production
- 85. (d) When total utility is maximum at the 5th unit, marginal utility is zero
- 86. (c) Revealed preference theory, pioneered by American economist Paul Samuelson, is a method of analyzing choices made by individuals
- 87. (a) One carat is equal to 0.2 grams
- 88. (c) Wood spirit is a poisonous colorless liquid used as a solvent and fuel; ingestion may cause blindness or death. Called also methyl or wood alcohol.

89. (d) Naphthalene is an organic compound with formula $C_{10}H_8$. It is the simplest polycyclic. Naphthalene is the most abundant single component of coal tar.
90. (d) Agronomy is the science and technology of producing and using plants for food, fuel, fiber, and land reclamation
91. (b) Guru Gobind Singh was The Tenth Nanak or the last of the Sikhpreachers to live.
92. (c) The Tattwabodhini Sabha ("Truth Propagating/Searching Society") was a group started in Calcutta on 6 October 1839 as a splinter group of the Brahmo Samaj, reformers of Hinduism and Indian Society. The founding member was Debendranath Tagore
93. (c) After the revolt, the British pursued the policy of divide and rule, towards the general populace.
94. (a) Prithvi (Sanskrit: prthvi "Earth") is a tactical surface-to-surface short-range ballistic missile .This class of Prithvi missile was inducted into the Indian Army in 1994
95. (b) FIFA's decision to award Russia the right to host the 2018 World Cup surprised many - including some of the country's leaders
96. (b) Habeas corpus ("You may have the body") is a recourse in law whereby a person can report an unlawful detention or imprisonment before a court, usually through a prison official
97. (d) Professor K.C. Wheare, who regards the American constitution as the model of a true federation has described the Indian constitution as 'quasi federal', that is 'a unitary state with subsidiary federal features rather than a federal state with subsidiary unitary features
98. (b) Many people believe Hitler was the personification of evil. In this Sibert Medal-winning biography, James Cross Giblin penetrates this façade and presents a picture of a complex person-at once a brilliant, influential politician and a deeply disturbed man. Giblin explores the forces that shaped the man as well as the social conditions that furthered his rapid rise to power.
99. (c) Cows are raised in many different countries around the world, mainly for the cowsnatural resources such as milk, meat
100. (c) Monera Kingdom- All the organisms of this kingdom are prokaryotes
101. (a) Anupama Mohan is one of the best-known disciples of Kuchipudi.
102. (a) 103. (b) 104. (a) 105. (b) 106. (b)
107. (c) 108. (d) 109. (d) 110. (d) 111. (d)
112. (c) 113. (c) 114. (a) 115. (a)
116. (b) Argentina, Argentina women's hockey team defeated Netherlands women's team to win the women's Hockey Junior World Cup 2016 in Santiago, Chile.
117. (b) December 7, Every year 7th December was celebrated as the International Civil Aviation Day since 1994 to promote safety, efficiency of air transport. 2016 Theme: "Working together to ensure no country is left behind".
118. (b) 119. (a) 120. (b)

ARITHMETIC

1. What is the value of

$$2 + \sqrt{2} + \frac{1}{2 + \sqrt{2}} - \frac{1}{2 - \sqrt{2}} ?$$

- (a) 2 (b) $2 - \sqrt{2}$
 (c) $4 + \sqrt{2}$ (d) $2\sqrt{2}$

2. What is the value of
- $1.\overline{34} + 4.\overline{12}$
- ?

- (a) $\frac{133}{90}$ (b) $\frac{371}{90}$
 (c) $5\frac{219}{990}$ (d) $5\frac{461}{990}$

3. A sum of money is divided among A, B, C and D in the ratio 3 : 5 : 8 : 9 respectively. If the share of D is ₹ 1,872 more than the share of A, then what is the total amount of money of B & C together?

- (a) ₹ 4,156 (b) ₹ 4,165
 (c) ₹ 4,056 (d) ₹ 4,068

4. What approximate compound interest can be obtained on an amount of ₹ 3,980 after 2 years at 8 p.c.p.a. ?

- (a) 650 (b) 680
 (c) 600 (d) 662

5. A man walks at the speed of 5 km/hr and runs at the speed of 10 km/hr. How much time will the man require to cover the distance of 28 km, if he covers half (first 14 km) of his journey walking and half of his journey running ?

- (a) 8.4 hrs (b) 6 hrs
 (c) 5 hrs (d) 4.2 hrs

6. In a 30 litres mixture of water and milk, 50% is milk. How much pure milk need to be added to this mixture to make mixture 30% water?

- (a) 10 litres (b) 18 litres
 (c) 15 litres (d) 20 litres

7. A bag contains 5 green and 7 red balls. Two balls are drawn. The probability that one is green and the other is red is

- (a) $\frac{5}{132}$ (b) $\frac{7}{132}$
 (c) $\frac{35}{66}$ (d) $\frac{31}{66}$

8. By selling 8 dozen pencils, a shopkeeper gains the selling price of 1 dozen pencils. What is the gain?

- (a) $12\frac{1}{2}\%$ (b) $13\frac{1}{7}\%$
 (c) $14\frac{2}{7}\%$ (d) $87\frac{1}{2}\%$

9. Two houses are collinear with the base of a tower and are at distance 3 m and 12 m from the base of the tower. The angles of elevation from these two houses of the top of the tower are complementary. What is the height of the tower?

- (a) 4m (b) 6m
 (c) 7.5m (d) 36m

- 10.

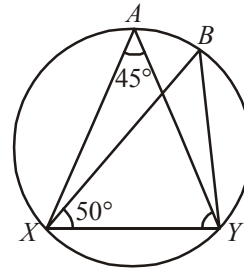

In the figure given above, what is $\angle BYX$ equal to?

- (a) 85° (b) 50°
 (c) 45° (d) 90°

11. In the given figure,
- $\triangle ABC$
- is a right angled triangle, right angled at A. Semi-circles are drawn on the sides AB, BC and AC. Then, the area of shaded portion is equal to which one of the following?

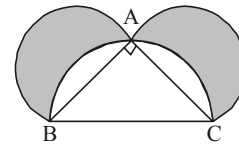

- (a) Area of DABC
 (b) 2 times the area of DABC
 (c) Area of semi-circle ABC
 (d) None of the above

12. In the given figure, the side of square ABCD is 7 cm. What is the area of the shaded portion, formed by the arcs BD of the circles with centre at C and A?

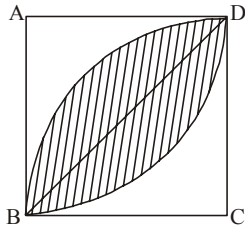

- (a) 7 cm^2 (b) 28 cm^2
 (c) 14 cm^2 (d) 21 cm^2
13. In the figure given below $AO = CD$, where O is the centre of the circle. What is the value of $\angle APB$?

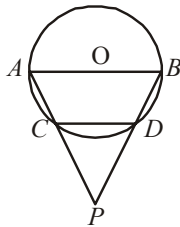

- (a) 60° (b) 50°
 (c) 45° (d) 30°
14. The length of a line segment AB is 2 unit. It is divided into two parts at the point C such that $AC^2 = AB \times CB$. What is the length of CB ?
- (a) $3\sqrt{2}$ units (b) $3 - \sqrt{5}$ units
 (c) $2 - \sqrt{5}$ units (d) $\sqrt{3}$ units
15. If $\frac{37}{13} = 2 + \frac{1}{x + \frac{1}{y + \frac{1}{z}}}$

where x, y, z are natural numbers, then what is z equal to?

- (a) 1
 (b) 2
 (c) 3
 (d) Cannot be determined due to insufficient data
16. What is $27 \times 1.\bar{2} \times 5.52\bar{6}2 \times 0.\bar{6}$ equal to?
- (a) $121.\bar{57}$ (b) $121.\bar{75}$
 (c) $121.\bar{75}$ (d) None of these

DIRECTIONS (Q. 17): What should come in place of the question mark (?) in the following questions?

17. $8^{9.4} \times 4^{12.8} \times 64^{8.1} = 16^?$
 (a) 41.8 (b) 16.2
 (c) 18.4 (d) 25.6
18. If $\tan x = \frac{3}{4}$, where $0^\circ < x < 90^\circ$, then what is the value of $\sin x \cos x$?

- (a) $\frac{3}{5}$ (b) $\frac{4}{5}$
 (c) $\frac{12}{25}$ (d) $\frac{13}{25}$

19. If $\frac{\cos x}{1 + \operatorname{cosec} x} + \frac{\cos x}{\operatorname{cosec} x - 1} = 2$, then which one of the following is one of the values of x ?

- (a) $\frac{\pi}{2}$ (b) $\frac{\pi}{3}$
 (c) $\frac{\pi}{4}$ (d) $\frac{\pi}{6}$

20. If α and β are the roots of $ax^2 + bx + c = 0$, then

what is the value of $\left(\frac{1}{\alpha^2} - \frac{1}{\beta^2}\right)^2$?

- (a) $\frac{b^2(b^2 - 4ac)}{c^4}$ (b) $\frac{b(b^2 - 4ac)}{c^2}$
 (c) $\frac{(b^2 - 4ac)}{c^2}$ (d) $\frac{(b^2 - 4ac)}{c^4}$

DIRECTIONS (Q. 21 - 23): Study the following table carefully in answer the questions that follow :

Number of Executives recruited by Six different organisations over the years

Organisation	P	Q	R	S	T	U
2004	458	512	418	502	476	492
2005	522	536	472	500	482	523
2006	480	495	464	508	488	518
2007	506	505	428	444	490	534
2008	427	485	422	512	510	498
2009	492	488	444	499	512	510

21. What is the total number of Executives recruited by all the organisations together in the year 2006?
 (a) 2927 (b) 3042
 (c) 2864 (d) 2953
22. What is the ratio of the total number of Executives recruited by organisation U in the years 2007 and 2009 together to the total number of Executives recruited by organisation P in the same years?
 (a) 436 : 517 (b) 499 : 522
 (c) 517 : 436 (d) 522 : 499

23. What is the average number of Executives recruited by organisation S over all the years together? (rounded off to the nearest integer)
- (a) 494 (b) 482
(c) 514 (d) 506
24. A hollow cylindrical iron pipe of length 1.4 m has base radius 2.5 cm and thickness of the metal is 1 cm. What is the volume of the iron used in the pipe?
- (a) 2640 cu cm (b) 2604 cu cm
(c) 2460 cu cm (d) None of these
25. A solid metallic cube of edge 4 cm is melted and recast into solid cubes of edge 1 cm. If x is the surface area of the melted cube and y is the total surface area of all the cubes recast, then what is $x : y$?
- (a) 2 : 1 (b) 1 : 2
(c) 1 : 4 (d) 4 : 1
26. If *381 is divisible by 11, then the digit at the place of * is :
- (a) 0 (b) 1
(c) 4 (d) 7
27. $\frac{\sqrt{1156}}{\sqrt{289}} = ?$
- (a) 24 (b) 25
(c) 23 (d) 22
28. Product of two co-prime numbers is 117. Their L.C.M. should be:
- (a) 1
(b) 117
(c) equal to their H.C.F.
(d) cannot be calculated
29. The average of four consecutive odd numbers is 36. What is the smallest of these numbers ?
- (a) 31 (b) 35
(c) 43 (d) None of these
30. By selling 33 metres of cloth, a man gains the sale price of 11 metres. The gain % is
- (a) 50% (b) 25%
(c) $33\frac{1}{3}\%$ (d) 20%
31. Ninad, Vikas and Manav enter into a partnership. Ninad invests some amount at the beginning. Vikas invests double the amount after 6 months and Manav invests thrice the amount invested by Ninad after 8 months. They earn a profit of ₹45,000 at the end of the year. What is Manav's share in the profit?
- (a) ₹25,000 (b) ₹15,000
(c) ₹12,000 (d) ₹9,000
32. 40 men can cut 60 trees in 8 hrs. If 8 men leave the job how many trees will be cut in 12 hours ?
- (a) 72 (b) 60
(c) 48 (d) 36
33. A monkey ascends a greased pole 12 metres high. He ascends 2 metres in first minute and slips down 1 metre in the alternate minute. In which minute, he reaches the top ?
- (a) 21st (b) 22nd
(c) 23rd (d) 24th
34. A circular grass lawn of 35 metres in radius has a path 7 metres wide running around it on the outside. Find the area of path.
- (a) 1694 m^2 (b) 1700 m^2
(c) 1598 m^2 (d) None of these
35. The cost price of 20 articles is equal to the selling price of 25 articles. The loss percent in the transaction is
- (a) 5 (b) 20
(c) 25 (d) 30
36. 10 horses and 15 cows eat grass of 5 acres in a certain time. How many acres will feed 15 horses and 10 cows for the same time, supposing a horse eats as much as 2 cows ?
- (a) $40/7$ acres (b) $39/8$ acres
(c) $40/11$ acres (d) $25/9$ acres
37. A car travels 25 km an hour faster than a bus for a journey of 500 km. If the bus takes 10 hours more than the car, then the speeds of the bus and the car are
- (a) 25 km/h and 40 km/h respectively
(b) 25 km/h and 60 km/h respectively
(c) 25 km/h and 50 km/h respectively
(d) None of these
38. If $x : y = 3 : 4$, then $(7x + 3y) : (7x - 3y)$ is equal to :
- (a) 5 : 2 (b) 4 : 3
(c) 11 : 3 (d) 37 : 19
39. If $x + \frac{1}{x} = \sqrt{3}$, then the value of $x^{18} + x^{12} + x^6 + 1$ is
- (a) 0 (b) 1
(c) 2 (d) 3
40. If $\frac{\tan \theta + \cot \theta}{\tan \theta - \cot \theta} = 2$, ($0 \leq \theta \leq 90$), then the value of $\sin \theta$ is
- (a) $\frac{2}{\sqrt{3}}$ (b) $\frac{\sqrt{3}}{2}$
(c) $\frac{1}{2}$ (d) 1

**GENERAL INTELLIGENCE &
REASONING**

DIRECTIONS (Qs. 41-43) : In questions, select the related word/letters/number from given alternatives.

41. ACE : FHJ :: OQS : ?
 (a) TVX (b) UWY (c) PRT (d) RTU
42. Saint : Meditation :: Scientist : ?
 (a) Research (b) Knowledge
 (c) Spiritual (d) Rational
43. 18 : 5 :: 12 : ?
 (a) 4 (b) 10 (c) 3 (d) 6

DIRECTIONS (Qs. 44 - 45) : In questions, find the odd word/letters/number pair from the given alternatives.

44. (a) Kolkata (b) Vishakhapatnam
 (c) Bengaluru (d) Haldia
45. (a) HGFE (b) PONM
 (c) DCBA (d) MSTU

DIRECTIONS (Qs. 46-47) : In questions below, a series is given with one term missing. Choose the correct alternative from the given ones that will complete the series.

46. FAG, GAF, HAI, IAH, _____
 (a) JAK (b) HAK (c) JAI (d) HAL
47. 3, 6, 9, 15, 24, 39, 63, ?
 (a) 100 (b) 87 (c) 102 (d) 99
48. If A = 1, AGE = 13, then CAR = ?
 (a) 19 (b) 20 (c) 21 (d) 22
49. Arrange the following words as per order in the dictionary:
 1. Emplane 2. Empower
 3. Embrace 4. Elocution
 5. Equable
 (a) 5, 1, 3, 2, 4 (b) 4, 2, 1, 3, 5
 (c) 4, 3, 1, 2, 5 (d) 4, 5, 2, 3, 1

DIRECTION (Qs. 50) : In question below, which one set of letters when sequentially placed at the gaps in the given letter series shall complete it?

50. LU_TUPLUBTU_LUBT_P_UBTUP
 (a) LBPU (b) BPUL
 (c) PBUL (d) BUPL
51. Govind is 48 years old. He is twice as old as his son Prem is now. How old was Prem seven years before ?
 (a) 16 (b) 17 (c) 13 (d) 18
52. Pointing to a man, a lady said "His mother is the only daughter of my mother". How is the lady related to the man?
 (a) Mother (b) Daughter
 (c) Sister (d) Aunt

53. After walking 10 m, Shankar turned left and covered a distance of 6 m, then turned right and covered a distance of 20 m. In the end, he was moving towards the south. From which direction did Shankar start his journey?
 (a) West (b) North
 (c) South (d) East

54. If '-' stands for '+', '+' stands for '×', '×' stands for '-' then which one of the following is not correct ?
 (a) $22 + 7 - 3 \times 9 = 148$
 (b) $33 \times 5 - 10 + 20 = 228$
 (c) $7 + 28 - 3 \times 52 = 127$
 (d) $44 - 9 + 6 \times 11 = 87$

55.

11		22		121				
3	28	4	5	57	3	6	?	5
	5			20			25	

 (a) 176 (b) 115
 (c) 157 (d) 131

56.

	63		
	7	9	1
3	1	7	?

 (a) 3 (b) 9
 (c) 5 (d) 2

57. Five policemen are standing in a row facing south. Shekhar is to the immediate right of Dhanush. Bala is between Basha and Dhanush. David is at the extreme right end of the row. Who is standing in the middle of the row?
 (a) Bala (b) Basha
 (c) Shekhar (d) Dhanush

DIRECTIONS (Qs. 58) : In the following question, one statement is given followed by two conclusions I and II. You have to consider the statements to be true even if they seem to be at variance from commonly known facts. You have to decide which of the given conclusions, if any follow from the given statements.

58. **Statement :** Songs always have singers to sing them.

Conclusions:

- I. Singers make a song.
 II. There is no un-sung song.
 (a) Only conclusion II follows
 (b) Both conclusions I and II follow
 (c) Neither conclusion I nor II follows
 (d) Only conclusion I follows

59. Which of the following states the relationship between Sociology, Psychology and Humanities ?

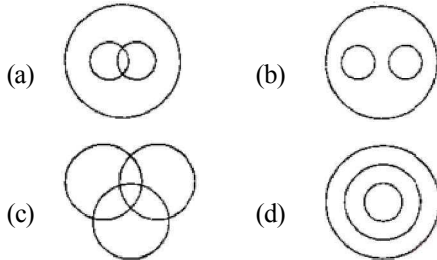

60. Select the related figure from the given alternatives.

Question figures

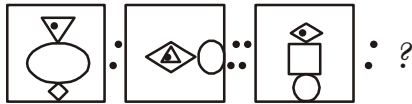

Answer figures

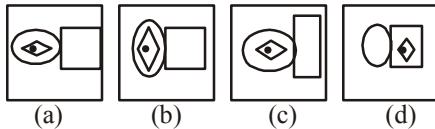

61. From the given alternatives select the word which can be formed using the letters given in the word.

ULTRANATIONALISM

- (a) ULTRAMONTANE
- (b) ULTRAMODERN
- (c) ULTRAIST
- (d) ULULATE

62. In the following question, select the answer figure in which the question figure is hidden / embedded.

Question Figure:



Answer Figures:

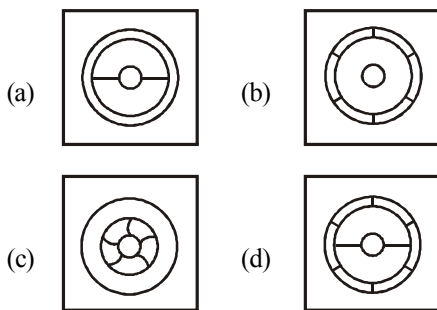

DIRECTIONS (63-64) : In each of the following questions, a piece of paper is folded and cut as shown below in the question figures. From the given answer figures, indicate how It will appear when opened?

63. **Question Figures:**

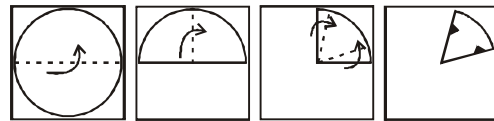

Answer Figures:

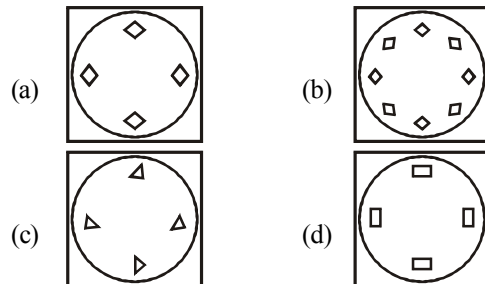

64. **Question Figures:**

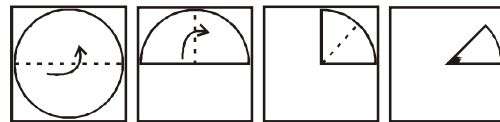

Answer Figures:

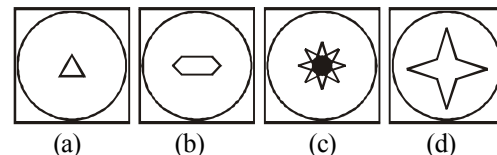

65. A word is represented by only one set of numbers as given in anyone of the alternatives. The sets of numbers given in the alternatives are represented by two classes of alphabets as in two matrices given below. The columns and rows of matrix I are numbered from 0 to 4 and that of matrix II numbered from 5 to 9. A letter from these matrices can be represented first by its row and next by its column e.g.. 'B' can be represented by 01, 10, 22, etc. and 'F' can be represented by 55, 76, 86, etc. Similarly, you have to identify the set for the given word - CAGE.

Matrix-I

	0	1	2	3	4
0	A	B	C	D	E
1	B	C	D	E	A
2	C	D	B	A	E
3	D	C	B	E	A
4	E	B	A	C	D

Matrix-II

	5	6	7	8	9
5	F	G	H	I	J
6	G	F	I	J	H
7	I	F	G	J	H
8	H	F	G	I	J
9	J	F	G	J	I

- (a) 95, 82, 31, 14 (b) 20, 00, 65, 40
 (c) 14, 20, 41, 86 (d) 00, 21, 41, 95
66. In a certain code, a number 13479 is written as AQFJL and 2568 is written as DMPN. How is 396824 written in that code?
 (a) QLPNMJ (b) QLPNMF
 (c) QLPMNF (d) QLPNDF
67. In a certain code OVER is written as \$#%*. and VIST is written as #+×-. How is SORE written in that code?
 (a) ×\$*% (b) %×\$*
 (c) ×*\$% (d) ×%*\$
68. A boy goes to see a film and finds a man who is his relative. The man is the husband of the sister of his mother. How is the man related to the boy?
 (a) Brother (b) Nephew
 (c) Uncle (d) Father
69. Laxman went 15 km to the west from my house, then turned left and walked 20 km. He then turned East and walked 25 km and finally turning left covered 20 km. How far was he from my house?
 (a) 5 km (b) 10 km
 (c) 40 km (d) 80 km
70. Rearrange the first four letters, in any way, of the word DECISION. Find how many words can be formed by using all the four words.
 (a) One (b) Two
 (c) Three (d) More than three
71. In the following question a word is given followed by four different words, one of which can be formed by using the letter of the given word find the word.
'IMMEDIATELY'
 (a) DIALECT (b) LIMITED
 (c) DIAMETER (d) DICTATE
72. Five boys took part in a race. Raj finished before Mohit but behind Gaurav. Ashish finished before Sanchit but behind Mohit. Who won the race?
 (a) Raj (b) Gaurav
 (c) Mohit (d) Ashish

DIRECTIONS (Qs. 73-75) : Study the following information carefully to answer the given questions.

Eight friends A, B, C, D, E, F, G and H are sitting around a circle facing the centre but not necessarily in the same order. G sits third to left of D. Only one person sits between D and F. B sits second to right of H. H is not an immediate neighbour of D. C is not an immediate neighbour of D. E is an immediate neighbour of H.

73. What is the position of E with respect to the position of C?
 (a) Third to the left (b) Second to the left
 (c) Immediate right (d) Third to the right
74. Who amongst the following sits exactly between A and G?
 (a) B (b) C
 (c) E (d) F
75. Four of the following five are alike in a certain way and thus form a group. Which is the one that does not belong to that group?
 (a) CG (b) AE
 (c) HD (d) EC

DIRECTIONS (Q. 76-77): Below is given a figure made of three circles intersecting one another. These circles represent graduates, typists and Government employees. The intersecting regions have been denoted by a, b, c, e, f, g and h, respectively. Study the diagram carefully and answer the questions that follow.

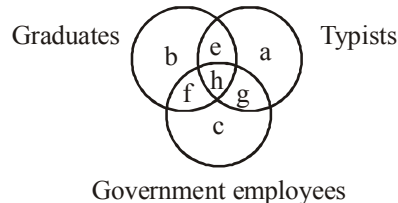

76. Which of the following letters represents the typists who are only graduates?
 (a) e (b) h (c) g (d) a
77. Which of the following letters represents the typists who are government employees but not graduates?
 (a) e (b) g (c) f (d) h

DIRECTIONS (Qs. 78-80): Answer these questions referring to the symbol-letter-number sequence given below:

E G 4 B H 7 5 @ K 8 D N £ Q Z \$ W 3 C 1 9 * 1 B 2 S 6

78. How many such consonants are there in the above sequence which are immediately preceded by a symbol and immediately followed by a digit?
 (a) One (b) Two
 (c) None (d) Three

79. What should come in place of the question mark (?) in the following sequence?
4H@, K D Q, ?, 9 I S
(a) ZW1 (b) NQ\$
(c) @8N (d) \$W9
80. Which of the following is exactly in the midway between the ninth from left end and the seventh from right end?
(a) Q (b) Z (c) \$ (d) W

GENERAL AWARENESS

81. Which one of the following is not a computer language?
(a) Cobol (b) Visual Basic
(c) HTML (d) Netscape
82. Who among the following was the first Governor General of India?
(a) Lord Amherst
(b) Lord William Bentinck
(c) Sir Charles Metcalfe
(d) Robert Clive
83. Which one of the following is not a constituent of biogas?
(a) Methane (b) Carbon dioxide
(c) Hydrogen (d) Nitrogen dioxide
84. In which one of the following sessions was the Indian National Congress split into moderates and extremists?
(a) Nagpur (b) Allahabad
(c) Surat (d) Calcutta
85. Bar is a unit of which one of the following?
(a) Force (b) Energy
(c) Pressure (d) Frequency
86. Which of the following metals are present in haemoglobin and chlorophyll, respectively?
(a) Fe and Mg (b) Fe and Zn
(c) Mg and Zn (d) Zn and Mg
87. A mother of blood group O has a group O child. What could be the blood group of father of the child?
(a) Only O (b) A or B or O
(c) A or B (d) Only AB
88. Who among the following was the founder of the Muslim League?
(a) Muhammad Ali Jinnah
(b) Shaukat Ali
(c) Nawab Salimullah
(d) Aga Khan
89. Which one among the following is **not** a source of tax revenue for the Central Government in India?
(a) Income tax (b) Customs duties
(c) Service tax (d) Motor Vehicle tax
90. Which of the following does **not** form part of current account of Balance of Payments?
(a) Export and import of goods
(b) Export and import of services
(c) Income receipts and payments
(d) Capital receipts and payments
91. Which one of the following Schedules of the Constitution of India includes the disqualification of a Legislator on grounds of defection?
(a) 8th Schedule (b) 7th Schedule
(c) 9th Schedule (d) 10th Schedule
92. Which one of the following causes the chikungunia disease?
(a) Bacteria (b) Helminthic worm
(c) Protozoan (d) Virus
93. Who among the following recommends to the Parliament for the abolition of the Legislative Council in a State?
(a) The President of India
(b) The Governor of the concerned State
(c) The Legislative Council of the concerned State
(d) The Legislative Assembly of the concerned State
94. Which one of the following vitamins helps in clotting of blood?
(a) Vitamin-A (b) Vitamin-B₆
(c) Vitamin-D (d) Vitamin-K
95. The 'Thomas Cup' is associated with
(a) Table Tennis (b) Lawn Tennis
(c) Badminton (d) Billiards
96. Which one among the following pairs is correctly matched?
(a) The Second Battle of Tarain : Defeat of Jaichand of Kannauj by Muhammad of Ghori
(b) The First Battle of Panipat : Defeat of Sikander Lodhi by Babur
(c) The Battle of Chausa : Defeat of Humayun by Sher Shah
(d) The Battle of Khanwa : Defeat of Rana Pratap by Akbar
97. What is the purpose of adding baking soda to dough?
(a) To generate moisture
(b) To give a good flavour
(c) To give good colour
(d) To generate carbon dioxide
98. The 'Arthashastra' is a treatise on which one of the following?
(a) Economics
(b) Environment
(c) Political Philosophy
(d) Religion in Administration

99. Which one of the following glands in the human body stores iodine?
 (a) Parathyroid (b) Thyroid
 (c) Pituitary (d) Adrenal
100. India's first integrated Defense Communication Network (DCN) has been launched in which of the following cities?
 (a) New Delhi (b) Lucknow
 (c) Ahmedabad (d) Kochi
101. The book "The mind of the terrorist: the Psychology of terrorism from the IRA to al-Qaeda" has been authored by whom?
 (a) Amitav Ghosh (b) Ashwin Sanghi
 (c) Kunal Basu (d) Jerrold M. Post
102. The Government of India (GoI) has extended the ban on the import of milk and milk products of China till which year?
 (a) June 2017 (b) March 2017
 (c) December 2017 (d) January 2017
103. What is the recently extended deadline for states to join Union Government's Ujwal Discom Assurance Yojana (UDAY) scheme?
 (a) March 2017 (b) January 2018
 (c) March 2018 (d) January 2017
104. As of now, how many countries are members of Nuclear Suppliers Group (NSG)?
 (a) 48 (b) 56
 (c) 64 (d) 96
105. India's first AYUSH university will be set up in which state of India?
 (a) Sikkim (b) Haryana
 (c) Karnataka (d) West Bengal
106. Junk e-mail is also called
 (a) Crap (b) Spoof
 (c) Sniffer script (d) Spam
107. A program designed to destroy data on your computer which can travel to 'infect' other computers is called a
 (a) Disease (b) Torpedo
 (c) Hurricane (d) Virus
108. File extension is used
 (a) For naming the file
 (b) To ascertain that file name is not lost
 (c) To identify file
 (d) To identify file type
109. ALU of CPU has
 (a) RAM space
 (b) Register
 (c) Byte space
 (d) Secondary storage space
110. What happens when operating system is located in RAM?
 (a) Copying (b) Device driving
 (c) Booting (d) Multitasking
111. Gorakhpur which has the longest railway platform in the world is located in which of the following states?
 (a) Odisha (b) West Bengal
 (c) Uttar Pradesh (d) Chhattisgarh
112. Which of the following stations has all the three gauges viz. broad, metre and narrow?
 (a) Lucknow (b) Chandigarh
 (c) Shimla (d) Siliguri
113. What is the width of broad gauge railway line in India?
 (a) 5 feet 3 inches (b) 5 feet 6 inches
 (c) 4 feet 11 inches (d) 5 feet 4 inches
114. Match the manufacturing units with their locations
- | Manufacturing Unit | State |
|----------------------------------|----------------|
| A. Chittaranjan Locomotive Works | 1. Tamilnadu |
| B. Integral Coach Factory | 2. Punjab |
| C. Wheel and Axle Plant | 3. West Bengal |
| D. Rail Coach Factory | 4. Karnataka |
- (a) A - 3; B - 4; C - 1; D - 2
 (b) A - 2; B - 1; C - 4; D - 3
 (c) A - 3; B - 1; C - 4; D - 2
 (d) A - 3; B - 1; C - 2; D - 4
115. Which of the following stations was formerly known as Victoria Terminus?
 (a) Churchgate Railway Station
 (b) Mumbai Central
 (c) Lokmanya Tilak Terminus
 (d) Chhatrapathi Shivaji Terminus
116. Which Country will host FIFA World Cup 2022?
 (a) Qatar (b) Brazil
 (c) France (d) Russia
117. Which country recently issued currency based on polymer rather than paper?
 (a) India
 (b) TheUnitedStatesofAmerica
 (c) England
 (d) France
118. Which male athlete has been crowned IAAF male athlete of the year 2016?
 (a) UsainBolt (b) BritonMoFarah
 (c) ThiagoBraz (d) EliudKipchoge
119. The winner of the International Children's Peace Prize 2016 belongs to which country?
 (a) India (b) Pakistan
 (c) Bangladesh (d) Nepa
120. Who has been named as the Forbes Asia's Businessman of the Year for 2016 ?
 (a) Wang Jianlin (b) Huanming Yang
 (c) Cheng Wei (d) Haojing Shao

Hints & Explanations

1. (a) $2 + \sqrt{2} + \frac{1}{2 + \sqrt{2}} - \frac{1}{2 - \sqrt{2}}$
 $= 2 + \sqrt{2} + \frac{2 - \sqrt{2} - 2 - \sqrt{2}}{4 - 2}$
 $= 2 + \sqrt{2} + \frac{(-2\sqrt{2})}{2} = 2 + \sqrt{2} - \sqrt{2} = 2$
2. (d) $\therefore 1.\overline{34} = \frac{134 - 1}{99} = \frac{133}{99}$
 and $4.\overline{12} = \frac{412 - 41}{90} = \frac{371}{90}$
 $\therefore 1.\overline{34} + 4.\overline{12} = \frac{133}{99} + \frac{371}{90} = \frac{1330 + 4081}{990}$
 $= \frac{5411}{990} = 5\frac{461}{990}$
3. (c) Share of B + C = $\frac{1872}{9 - 3} \times (5 + 8) = ₹ 4056$
4. (d) Equivalent % interest for compound rate of interest of 8% for 2 years
 $= 8 + 8 + \frac{8 \times 8}{100} = 16.64\%$
 So, interest = 16.64% of 3980 \approx 662
5. (d) Total time required = $\frac{14}{5} \frac{14}{10}$
 $= \frac{28}{10} \frac{14}{10} = 4.2$ hrs
6. (d) 30 litres mixture contains 15 litres of water. When milk added to this, quantity of water will same in sance (i.e. 15l). Let x l of pure milk to be added, then 30% of $(30 + x) = 15$
 solve, $x = 20$
7. (c) There are $5 + 7 = 12$ balls in the bag and out of these two balls can be drawn in ${}^{12}C_2$ ways. There are 5 green balls, therefore, one green ball can be drawn in 5C_1 ways; similarly, one red ball can be drawn in 7C_1 ways so that the number of ways in which we can draw one green ball and the other red is ${}^5C_1 \times {}^7C_1$. Hence, P (one green and the other red)
 $= \frac{{}^5C_1 \times {}^7C_1}{{}^{12}C_2} = \frac{5}{1} \times \frac{7}{1} \times \frac{1 \times 2}{12 \times 11} = \frac{35}{66}$

8. (c) Let the cost price = ₹ x
 Profit = ₹ x
 Cost price of 8 dozen pencil = ₹ $7x$
 Gain per cent = $\frac{x}{7x} \times 100$
 $= \frac{100}{7} = 14\frac{2}{7}\%$
9. (b) Let the height of the tower be h m and $\angle CBD = \theta$ then $\angle DAC = 90^\circ - \theta$ (Because both angles are complementary)

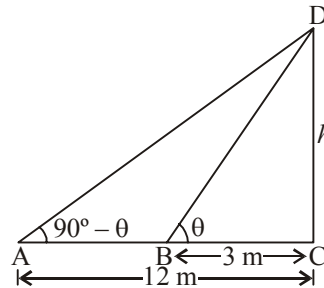

\therefore In $\triangle BCD$,

$$\tan \theta = \frac{CD}{BC} \Rightarrow \tan \theta = \frac{h}{3}$$

Now, in $\triangle ACD$

$$\tan (90^\circ - \theta) = \frac{CD}{AC} \Rightarrow \cot \theta = \frac{h}{12}$$

$$\frac{1}{\tan \theta} = \frac{h}{12}$$

$$h \tan \theta = 12$$

Put the value of $\tan \theta$

$$h \times \frac{h}{3} = 12$$

$$h^2 = 36 \quad \therefore h = 6$$

Then, height of tower = 6 m.

10. (a) We know that, the triangle of same segment of a circle makes an equal angles.
 $\therefore \angle XBY = \angle XAY = 45^\circ$
 In $\triangle BXY$, $\angle BXY + \angle XBY + \angle BYX = 180^\circ$
 $\Rightarrow 50^\circ + 45^\circ + \angle BYX = 180^\circ$
 $\therefore \angle BXY = 50^\circ$
 $\Rightarrow \angle BYX = 180^\circ - 95^\circ = 85^\circ$

11. (a) In ΔABC ,

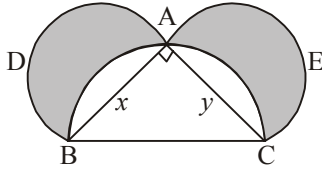

$$BC = \sqrt{x^2 + y^2}$$

$$\therefore \text{Area of } \Delta ABC = \frac{1}{2} \times x \times y = \frac{1}{2} xy$$

$$\text{Area of semi-circle BACB} = \frac{\pi(x^2 + y^2)}{4}$$

\therefore Area of shaded portion = Semi-circle ABDA + Area of semi-circle AECA - (Area of semi-circle BACB - Area of ΔABC)

$$= \frac{\pi x^2}{4} + \frac{\pi y^2}{4} - \pi \left(\frac{x^2 + y^2}{4} \right) + \text{Area of } \Delta ABC$$

$$= \text{Area of } \Delta ABC$$

12. (b)

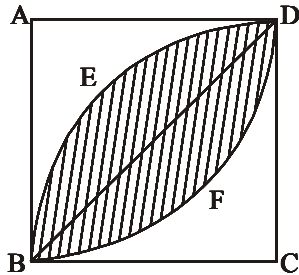

The above figure is symmetrical about BD

Area of shaded part

$$= 2 \times \text{Area of BEDB}$$

$$= 2 \times (\text{Area of BCDEB} - \text{Area of } \Delta BCD)$$

$$= 2 \left(\frac{\pi r^2}{4} - \frac{1}{2} \times BC \times CD \right)$$

$$= 2 \left(\frac{22}{7 \times 4} 7 \times 7 - \frac{1}{2} \times 7 \times 7 \right)$$

$$= 2 \times \frac{28}{2} = 28 \text{ cm}^2$$

13. (a)

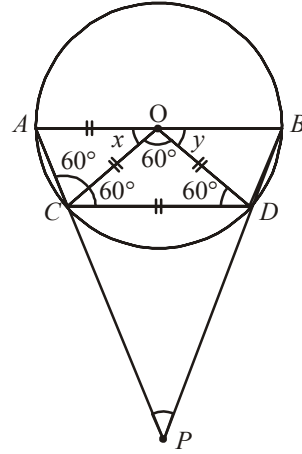

$$AO = CD$$

$$\Rightarrow OC = OD = CD$$

($\because AO = OC = OD = \text{radii}$)

So, ΔCOD is equilateral,

$$\angle x + \angle y = 180 - 60$$

and $\angle x = \angle y$

$$\therefore \angle 2x = 120^\circ$$

$$\angle x = 60^\circ$$

$$\angle DCP = 180^\circ - 120^\circ = 60^\circ$$

and $\angle CDP = 60^\circ$

$$\therefore \angle APB = 360^\circ - (60^\circ + 120^\circ + 120^\circ) = 60^\circ$$

14. (b) Given, $AC^2 = AB \times CB$

$$\Rightarrow x^2 = 2 \times (2 - x)$$

$$\Rightarrow x^2 = 4 - 2x$$

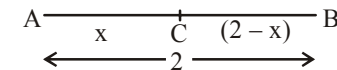

$$\Rightarrow x^2 + 2x - 4 = 0$$

$$\Rightarrow x = \frac{-2 \pm \sqrt{4 + 16}}{2 \times 1}$$

$$\Rightarrow x = -1 \pm \sqrt{5}$$

$$\text{Now, } BC = 2 - (-1 + \sqrt{5}) = 3 - \sqrt{5}$$

$$15. (b) \frac{37}{13} = 2 + \frac{1}{x + \frac{1}{y + \frac{1}{z}}}$$

$$\Rightarrow \frac{37}{13} \text{ can be expressed as}$$

$$= 2 + \frac{1}{2} = 2 + \frac{1}{1+1}$$

$$= 2 + \frac{1}{11} = 2 + \frac{1}{5 + \frac{1}{2}}$$

Now, this is compared by

$$2 + \frac{1}{x + \frac{1}{y + \frac{1}{z}}} = 2 + \frac{1}{1 + \frac{1}{5 + \frac{1}{2}}}$$

$$\boxed{\therefore z = 2}$$

16. (d) $27 \times 1.2 \times 5.5262 \times 0.6$

$$= 27 \times 1 \frac{2}{9} \times 5 \frac{4736}{9000} \times \frac{6}{9}$$

$$= 27 \times \frac{11}{9} \times \frac{49736}{9000} \times \frac{6}{9}$$

$$= \frac{11 \times 49736 \times 2}{9000} = \frac{1094192}{9000} = 121.577$$

17. (d) $8^{9.4} \times 4^{12.8} \times 64^{8.1} = 16^?$

$$8^{2 \times 4.7} \times 4^{12.8} \times 64^{8.1} = 16^?$$

$$64^{4.7} \times 4^{12.8} \times 64^{8.1} = 16^?$$

$$64^{4.7+8.1} \times 4^{12.8} = 16^?$$

$$(64 \times 4)^{12.8} = 16^?$$

$$(256)^{12.8} = 16^?$$

$$16^{2 \times 12.8} = 16^?$$

$$16^{25.6} = 16^?$$

$$? = 25.6$$

18. (c) Given, $\tan x = \frac{3}{4}$, $0^\circ < x < 90^\circ$

$$\therefore \sin x = \frac{\tan x}{\sqrt{1 + \tan^2 x}}, \quad 0^\circ < x < 90^\circ$$

$$= \frac{\frac{3}{4}}{\sqrt{1 + \frac{9}{16}}} = \frac{\frac{3}{4}}{\sqrt{\frac{25}{16}}} = \frac{3}{5} \text{ and}$$

$$\cos x = \frac{1}{\sqrt{1 + \tan^2 x}} = \frac{1}{\sqrt{1 + \left(\frac{3}{4}\right)^2}} = \frac{1}{\sqrt{\frac{16+9}{16}}} = \frac{4}{5}$$

$$\therefore \sin x \cos x = \frac{3}{5} \times \frac{4}{5} = \frac{12}{25}$$

19. (c) Given, $\frac{\cos x}{1 + \operatorname{cosec} x} + \frac{\cos x}{\operatorname{cosec} x - 1} = 2$

$$\Rightarrow \frac{2 \cos x \operatorname{cosec} x}{\operatorname{cosec}^2 x - 1} = 2$$

$$\Rightarrow \frac{\cos x \operatorname{cosec} x}{\cot^2 x} = 1$$

$$\Rightarrow \tan x = 1$$

$$\Rightarrow x = \frac{\pi}{4}$$

20. (a) α and β are the roots of the equation $ax^2 + bx + c = 0$

$$\therefore \alpha + \beta = -\frac{b}{a} \text{ and } \alpha\beta = \frac{c}{a}$$

$$\therefore \left(\frac{1}{\alpha^2} - \frac{1}{\beta^2}\right)^2 = \left(\frac{\beta^2 - \alpha^2}{\alpha^2\beta^2}\right)^2$$

$$= \frac{(\alpha + \beta)^2 \{(\alpha + \beta)^2 - 4\alpha\beta\}}{(\alpha^2\beta^2)^2}$$

$$= \frac{b^2 \left(\frac{b^2}{a^2} - \frac{4c}{a}\right)}{\left(\frac{c^2}{a^2}\right)^2}$$

$$= \frac{b^2}{c^4} (b^2 - 4ac)$$

$$= \frac{b^2}{c^4} (b^2 - 4ac)$$

21. (d) Total executives recruited were 2953.

22. (d) Required ratio equals 1044 : 998

$$= 522 : 499$$

23. (a) Required average number of executives =

$$\frac{\text{sum of no. of all executives}}{6} = \frac{2965}{6} \approx 494$$

24. (a) \therefore Volume of pipe, $V = \pi(r_1^2 - r_2^2) \times h$

$$= \frac{22}{7} [(3.5)^2 - (2.5)^2] \times 140$$

$$= \frac{22}{7} (12.25 - 6.25) \times 140$$

$$= 22 \times 6 \times 20 = 2640 \text{ cu cm}$$

25. (c) Volume of solid cube = $(4)^3 = 64 \text{ cm}^3$
 Volume of recast cube = $(1)^3 = 1 \text{ cm}^3$
 \therefore Total surface area of cube : Total surface area of recast cube
 $= x : y$
 $\Rightarrow x : y = 6(4)^2 : 6(1)^2 \times 64 = 1 : 4$
26. (d) Since 7381 is completely divisible by 11.
 \therefore The value of 1 * is 7.
27. (b)
28. (b) H.C.F of co-prime numbers is 1.
29. (d) $x + x + 2 + x + 4 + x + 6 = 4 \times 36$
 $\Rightarrow 4x + 12 = 144 \Rightarrow 4x = 144 - 12$
 $\Rightarrow 4x = 132 \Rightarrow x = \frac{132}{4} = 33$
30. (a) Gain = S.P. of 33 metres – C.P. of 33 metres
 = S.P. of 11 metres
 \Rightarrow S.P. of 22 metres = C.P. of 33 metres
 \therefore % gain = $\frac{\text{gain}}{\text{C.P. of metres}} \times 100$
 $= \frac{\text{S.P. of 11 metres}}{\text{C.P. of 33 metres}} \times 100$
 $= \frac{\text{S.P. of 11 metres}}{\text{S.P. of 22 metres}} \times 100 = \frac{11}{22} \times 100$
 $= 50\%$
31. (b) Ratio of profit = $1 \times 12 : 2 \times 6 : 3 \times 4 = 1 : 1 : 1$
 \therefore Manav's share = $45000 \times \frac{1}{3} = ₹ 15000$
32. (a) $M_1 = 40, D_1 = 8$ (As days and hrs both denote time)
 $W_1 = 60$ (cutting of trees is taken as work)
 $M_2 = 40 - 8 = 32, D_2 = 12, W_2 = ?$
 Putting the values in the formula
 $M_1 D_1 W_1 = M_2 D_2 W_2$
 We have, $40 \times 8 \times W_2 = 32 \times 12 \times 60$
 or, $W_2 = \frac{32 \times 12 \times 60}{40 \times 8} = 72$ trees.
33. (a) In 2 minutes, he ascends = 1 metre
 \therefore 10 metres, he ascends in 20 minutes.
 \therefore He reaches the top in 21st minute.
34. (a) Radius of a circular grass lawn (without path) = 35 m
 \therefore Area = $\pi r^2 = \pi(35)^2$
 Radius of a circular grass lawn (with path)
 $= 35 + 7 = 42 \text{ m}$
 \therefore Area = $\pi r^2 = \pi(42)^2$
 \therefore Area of path = $\pi(42)^2 - \pi(35)^2$
 $= \pi(42^2 - 35^2)$
 $= \pi(42 + 35)(42 - 35)$
 $= \pi \times 77 \times 7$
 $= \frac{22}{7} \times 77 \times 7 = 1694 \text{ m}^2$
35. (c) Let C.P. of 1 article = ₹ 1
 then C.P. of 25 articles = ₹ 25
 and S.P. of 25 articles = ₹ 20
 \therefore loss % = $\frac{25 - 20}{20} \times 100 = 25\%$
36. (a) 1 horse = 2 cows, 10 horses = 20 cows.
 \Rightarrow 10 horses + 15 cows = 20 + 15 = 35 cows.
 15 horses + 10 cows = 40 cows. Now 35 cows eat 5 acres.
 \Rightarrow 40 cows eat $5 \times \frac{40}{35} = 5 \frac{5}{7}$ acres.
 Here we have converted everything in terms of cows, you can work in terms of horses also.
37. (c) Let the speed of the bus be $x \text{ km/h}$.
 then speed of the car = $(x + 25) \text{ km/h}$
 $\therefore \frac{500}{x} = \frac{500}{x + 25} \times 10$
 $\Rightarrow x^2 + 25x - 1250 = 0 \Rightarrow x = 25$
 Thus speed of the bus = 25 km/h
 Speed of the car = 50 km/h
Alternative:
 Difference in speeds 25 km/hr is in only option (c).
38. (c) $\frac{x}{y} = \frac{3}{4} \Rightarrow \frac{7x}{3y} = \frac{7}{3} \times \frac{3}{4} = \frac{7}{4}$
 By componendo and dividendo,
 $\frac{7x - 3y}{7x + 3y} = \frac{7 - 4}{7 + 4} = \frac{3}{11}$
39. (a) $x + \frac{1}{x} = \sqrt{3}$
 Cubing both sides,
 $x^3 + \frac{1}{x^3} + 3\left(x + \frac{1}{x}\right) = (\sqrt{3})^3 \Rightarrow x^3 + \frac{1}{x^3} + 3\sqrt{3} = 3\sqrt{3}$

$$\Rightarrow x^3 + \frac{1}{x^3} = 0$$

Now,

$$x^{18} + x^{12} + y^6 + 1 = x^{12}(x^6 + 1) + 1(x^6 + 1)$$

$$= (x^{12} + 1)(x^6 + 1)$$

$$= (x^{12} + 1) \cdot x^3 \left(x^3 + \frac{1}{x^3} \right) = 0$$

40. (b) $\frac{\tan \theta + \cot \theta}{\tan \theta - \cot \theta} = \frac{2}{1}$
By componendo and dividendo,

$$\frac{2 \tan \theta}{2 \cot \theta} = \frac{3}{1}$$

$$\Rightarrow \frac{\sin \theta}{\cos \theta} \cdot \frac{\sin \theta}{\cos \theta} = 3$$

$$\Rightarrow \sin^2 \theta = 3 \cos^2 \theta$$

$$\Rightarrow \sin^2 \theta = 3(1 - \sin^2 \theta)$$

$$\Rightarrow 4 \sin^2 \theta = 3$$

$$\Rightarrow \sin^2 \theta = \frac{3}{4}$$

$$\Rightarrow \sin \theta = \frac{\sqrt{3}}{2}$$

41. (c)

A	C	E
+5 ↓	+5 ↓	+5 ↓
F	H	J

Similarly,

O	Q	S
+5 ↓	+5 ↓	+5 ↓
T	V	X

42. (a) As, a saint practices meditation. Similarly, a scientist does research.

43. (c) $18/3 - 1 = 5$
 $12/3 - 1 = \boxed{3}$

44. (c)

45. (d)

H	$\xrightarrow{(-)}$	G	$\xrightarrow{(-)}$	F	$\xrightarrow{(-)}$	E
P	$\xrightarrow{(-)}$	O	$\xrightarrow{(-)}$	N	$\xrightarrow{(-)}$	M
D	$\xrightarrow{(-)}$	C	$\xrightarrow{(-)}$	B	$\xrightarrow{(-)}$	A
M	$\xrightarrow{(+)}$	S	$\xrightarrow{(+)}$	T	$\xrightarrow{(+)}$	U

M S T U is odd word

46. (a) $F \xrightarrow{+1} G \xrightarrow{+1} H \xrightarrow{+1} I \xrightarrow{+1} J$
 $A \xrightarrow{+0} A \xrightarrow{+0} A \xrightarrow{+0} A \xrightarrow{+0} A$
 $G \xrightarrow{-1} F \xrightarrow{+3} I \xrightarrow{-1} H \xrightarrow{+3} K$

47. (c) $3 + 3 = 6$
 $6 + 3 = 9$
 $9 + 6 = 15$
 $15 + 9 = 24$
 $24 + 15 = 39$
 $39 + 24 = 63$
 $63 + 39 = 102$

48. (d) As, $A + G + E = 1 + 7 + 5 = 13$
Similarly, $C + A + R = 3 + 1 + 18 = 22$

49. (c) As per dictionary

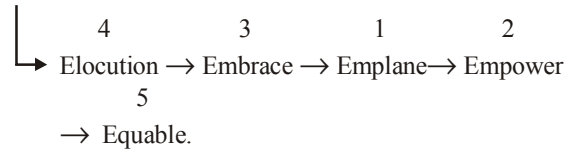

50. (b) Words LUB and TUP are in consecutive order.
LUB/TUP/LUB/TUP/LUB/TUP/
LUB/TUP

51. (b) Govind's age = 48 years
According to question
Prem's age = $48/2 = 24$ years
Prem's age seven years before = $24 - 7 = 17$ years.

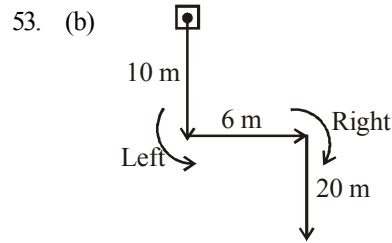
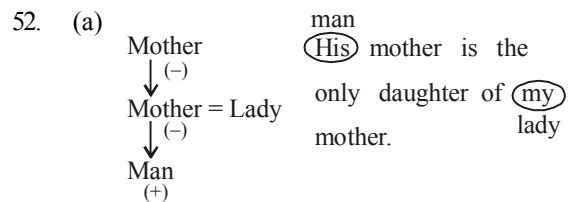

From the diagram, it is clear that Shankar started his journey from North to South.

54. (c) By options—
 (a) $22 \times 7 + 3 - 9 = 148$
 $154 + 3 - 9$
 $157 - 9 = 148$ (Correct)
 (b) $33 - 5 + 10 \times 20 = 228$
 $33 - 5 + 200$
 $200 + 33 - 5$
 $233 - 5 = 228$ (Correct)
 (c) $7 \times 28 + 3 - 52 = 127$
 $196 + 3 - 52$
 $199 - 52 = 147$ (Incorrect)
 (d) $44 + 9 \times 6 - 11 = 87$
 $44 + 54 - 11$
 $98 - 11 = 87$ (Correct)

55. (a)

11	22	121
$\boxed{\begin{matrix} 11 + 5 + 4 \times 3 \\ = 16 + 12 = 28 \end{matrix}}$	$\boxed{\begin{matrix} 22 + 20 + 5 \times 3 \\ = 42 + 15 = 57 \end{matrix}}$	$\boxed{\begin{matrix} 121 + 25 + 6 \times 5 \\ = 146 + 30 = 176 \end{matrix}}$
5	20	25

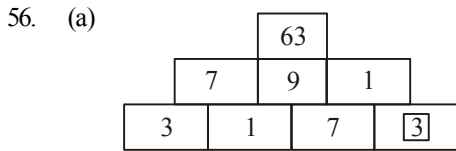

$\Rightarrow 63$
 $\Rightarrow 7 \times 1 \times 9 = 63$
 $\Rightarrow 3 \times 1 \times 7 \times \boxed{3} = 63$

57. (d) Standing arrangement : (facing south)

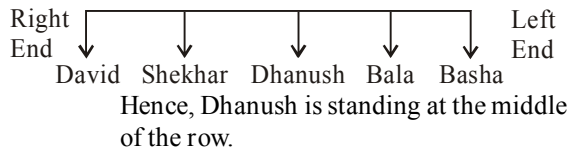

58. (d) Any written piece is recognised as song when it is sung by a singer. Therefore, only Conclusion I follows.

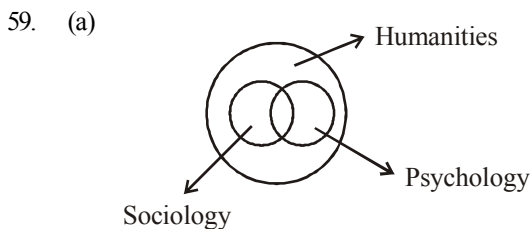

60. (a) The middle element adjacent to the right side line after rotating 90° anticlockwise. The bottom element goes up on the top and becomes enlarge. The top element becomes the inner figure of bottom element.
61. (c) By options—
 (a) can not be formed as there is no 'E' in the given word.
 (b) can not be formed as there is no 'D' in the given word.
 (d) can not be formed as there is no 'E' and only 'U' in the given word.
 So, option (c) can be formed.
62. (d) 63. (b) 64. (c)
 65. (b) $C \Rightarrow 02, 11, 20, 31, 43$
 $A \Rightarrow 00, 14, 23, 34, 42$
 $G \Rightarrow 56, 65, 77, 87, 97$
 $E \Rightarrow 04, 13, 24, 33, 40$

Option	C	A	G	E
(a)	95	82	31	14
(b)	20	00	65	40
(c)	14	20	41	86
(d)	00	24	41	95

66. (d) Given
- | | | | | | | | | |
|---|---|---|---|---|---|---|---|---|
| 1 | 3 | 4 | 7 | 9 | 2 | 5 | 6 | 8 |
| A | Q | F | J | L | D | M | P | N |
- From the above table, 396824 is coded as:

Thus,

3	9	6	8	2	4
Q	L	P	N	D	F

67. (a) Given,
- | | | | | | | | |
|----|---|---|---|---|---|---|---|
| O | V | E | R | V | I | S | T |
| \$ | # | % | * | # | + | × | - |

From the above table, SORE is coded as :

S	O	R	E
×	\$	*	%

68. (c) The sister of one's mother is one's maternal aunt. Hence, the man is the husband of the boy's maternal aunt.

69. (b) The direction movement of laxman is as following:

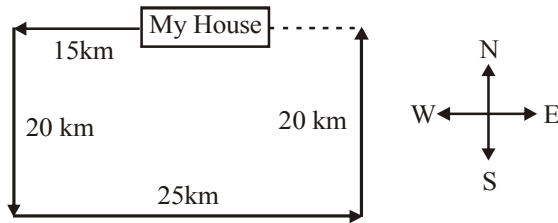

From the above diagram, required distance is = $25 - 15 = 10$ km.

70. (a) The first four letters are D, E, C, I and only word DICE can be formed. so, the answer is option (a).
71. (d) 'LIMITED' is the only word which can be formed using the letters of given word.
72. (b) The order in which the five boys reach the finishing line is, Gaurav > Raj > Mohit > Ashish > Sanchit.
Hence, Gaurav won the race.

(73-75):

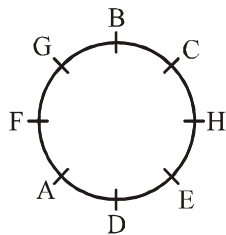

73. (b) Clearly, E is second to the left of C.
74. (d) F sits exactly between A and G.
75. (c) Except HD, in all other pairs, first member is present on the clockwise side of other.

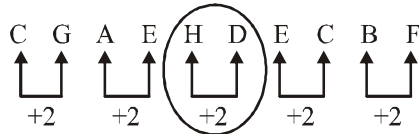

76. (a) Letter e represents the typists who are only graduates but not Government employees.
77. (b) Letter g represent the typists who are only Government employees but not graduates
78. (b) E G 4 B H 7 5 @ K 8 D N £ Q Z \$ W 3 C 1 9
* 1 B 2 S 6

79. (a) The first, second and third element of each group is sixth element to the right of the respective element of previous group as given in all in the sequence.
80. (b) There are 27 elements in all in the sequence. So, $(27 - 9 - 7 =)$ 11 elements are between the 9th from left and 7th from right. Hence, $(9 + 6 =)$ 15th element from the left and will be the required answer.
81. (d) Netscape is an Internet browser that was popular during the early 1990's.
82. (a)
83. (d) Nitrogen dioxide (NO_2) is not a component of biogas.
84. (c) The 23rd Session (1907) of the Congress was held at Surat. In the session, there was an open clash between the Moderates and the Extremists and ultimately it led to a split in the Congress.
85. (c) $1 \text{ Bar} = 10^5 \text{ Pa}$. Both bar and Pa are the unit of pressure.
86. (a) Fe and Mg metals are present in haemoglobin and chlorophyll respectively.
87. (b) The blood group of father of the child could be A or B or O.
88. (c) The All India Muslim League, a political organization was founded in 1906 by Aga Khan under the Nawab of Dhaka Salimullah. Its main purpose was to safeguard the political rights of Muslims in India.
89. (d) Motor Vehicle tax is not a source of tax revenue for the central government in India.
90. (d) Capital receipts and payments do not form part of current account of Balance of Payment.
91. (d) The 10th Schedule to the Indian Constitution is known as Anti-Defection Law. It was inserted by the 52nd Amendment Act 1985 to the Constitution. It sets the provisions for disqualification of elected members on the grounds of defection to another political party.
92. (d) Chikungunia is caused by chikenguniya virus which is an insect borne virus of genus *Alphavirus*. Symptoms show high fever, maculopapular rash, headache, etc.
93. (d)
94. (d) Vitamin-K adds in blood clotting. Vitamin-K acts as an essential cofactor for factor-II, VII, IX, X and also for proteins Z, C and S.

95. (c) Thomas Cup is associated with Badminton.
96. (b) First Battle of Panipat (1526) was fought between two mega-powers- Babur, then ruler of Kabul and Ibrahim Lodhi, king of Delhi Sultanate. It was fought near Panipat (present day Haryana). Babur won the battle and established the Mughal Empire. Second Battle of Panipat (1556) was fought between Akbar (Ruler of Mughal Dynasty) and Muhammad Adil Shah (ruler of Pashtan Suri Dynasty), along with his Prime Minister Hemu. Third Battle of Panipat (1761) was fought between the Afghans and the Marathas. The battle lasted for two months which ultimately resulted in the defeat of Marathas and end of their dominance in India.
97. (d) Baking soda has sodium bicarbonate as the chief constituent. It decomposes on heating giving carbon dioxide. This causes dough, cakes, biscuits etc. to expand and become light.
98. (c) The Arthashastra is a treatise on Political philosophy. The book, written in Sanskrit, discusses theories and principles of governing a state. The meaning of Arthashastra is 'Science of Polity'. It is written by Kautilya.
99. (b) Thyroid gland in human body contains iodine. Deficiency of iodine creates goitre disease. Which is observed by the enlargement of larynx.
100. (a) 101. (d) 102. (b) 103. (a)
104. (a) 105. (b) 106. (d) 107. (d)
108. (d) 109. (b) 110. (c) 111. (c)
112. (d) 113. (b) 114. (c) 115. (d)
116. (a) The 2022 FIFA World Cup will be hosted by Qatar. During a meeting between Qatari Prime Minister Sheikh Abdullah Bin Nasser Bin Khalifa Al Thani and Home Minister Rajnath Singh, India on December 3, 2016, India agreed to train Qatar's police for the FIFA World Cup 2022.
117. (c) 118. (a) 119. (a)
120. (c) Cheng Wei, Co-founder and Chief Executive of China's largest ride-sharing service provider Didi Chuxing (Didi) is Forbes Asia's Businessman of the Year for 2016. According to Forbes Asia, Didi has attracted 300 million users in 400 Chinese cities in just four years.

ARITHMETIC

- What is the value of $\sqrt{7.84} + \sqrt{0.0784} + \sqrt{0.000784} + \sqrt{0.00000784}$?
 (a) 3.08 (b) 3.108
 (c) 3.1008 (d) 3.1108
- A three-digit number is divisible by 11 and has its digit in the unit's place equal to 1. The number is 297 more than the number obtained by reversing the digits. What is the number ?
 (a) 121 (b) 231
 (c) 561 (d) 451
- What is 40% of 50% of $\frac{3}{4}$ of 3200 ?
 (a) 480 (b) 560
 (c) 420 (d) 600
- A bag contains 5 white and 7 black balls and a man draws 4 balls at random. The odds against these being all black is :
 (a) 7 : 92 (b) 92 : 7
 (c) 92 : 99 (d) 99 : 92
- A trader marked a watch 40% above the cost price and then gave a discount of 10%. He made a net profit of ₹ 468 after paying a tax of 10% on the gross profit. What is the cost price of the watch?
 (a) ₹ 1200 (b) ₹ 1800
 (c) ₹ 2000 (d) ₹ 2340
- 42 men take 25 days to dig a pond. If the pond would have to be dug in 14 days, then what is the number of men to be employed?
 (a) 67 (b) 75
 (c) 81 (d) 84
- If the diameter of a wire is decreased by 10%, by how much per cent (approximately) will the length be increased to keep the volume constant?
 (a) 5% (b) 17%
 (c) 20% (d) 23%
- From a series of 50 observations, an observation with value 45 is dropped but the mean remains the same. What was the mean of 50 observations?
 (a) 50 (b) 49
 (c) 45 (d) 40
- Mr Duggal invested ₹20,000 with rate of interest @ 20 pcpa. The interest was compounded half-yearly for the first one year and in the next year it was compounded yearly. What will be the total interest earned at the end of two years?
 (a) ₹ 8,800 (b) ₹ 9,040
 (c) ₹ 8,040 (d) ₹ 9,800
- If the area of a circle, inscribed in an equilateral triangle is $4\pi \text{ cm}^2$, then what is the area of the triangle?
 (a) $12\sqrt{3} \text{ cm}^2$ (b) $9\sqrt{3} \text{ cm}^2$
 (c) $8\sqrt{3} \text{ cm}^2$ (d) 18 cm^2
- In a right angled $\triangle ABC$, $\angle C = 90^\circ$ and CD is perpendicular to AB . If $AB \times CD = CA \times CB$, then $\frac{1}{CD^2}$ is equal to
 (a) $\frac{1}{AB^2} - \frac{1}{CA^2}$ (b) $\frac{1}{AB^2} - \frac{1}{CB^2}$
 (c) $\frac{1}{BC^2} - \frac{1}{CA^2}$ (d) $\frac{1}{BC^2} - \frac{1}{CA^2}$, if $CA > CB$
- E is the mid-point of the median AD of a $\triangle ABC$, If BE produced meets the side AC at F , then CF is equal to
 (a) $\frac{AC}{3}$ (b) $\frac{2AC}{3}$
 (c) $\frac{AC}{2}$ (d) None of these
- If three vertices of a regular hexagon are chosen at random, then the chance that they form an equilateral triangle is :
 (a) $\frac{1}{3}$ (b) $\frac{1}{5}$
 (c) $\frac{1}{10}$ (d) $\frac{1}{2}$
- A ladder of 17 ft length reaches a window which is 15 ft above the ground on one side of the street. Keeping its foot at the same point the ladder is turned to the other side of the street and now it reaches a window 8 ft high. What is the width of the street?
 (a) 23 ft (b) 15 ft
 (c) 25 ft (d) 30 ft

15. What is the value of

$$\frac{1}{1+\sqrt{2}} + \frac{1}{\sqrt{2}+\sqrt{3}} + \dots + \frac{1}{\sqrt{15}+\sqrt{16}} ?$$

- (a) 0 (b) 1
(c) 2 (d) 3

16. If $x + \left(\frac{1}{x}\right) = p$, then what is $x^6 + \left(\frac{1}{x^6}\right)$ equal to?

- (a) $p^6 + 6p$ (b) $p^6 - 6p$
(c) $p^6 + 6p^4 + 9p^2 + 2$ (d) $p^6 - 6p^4 + 9p^2 - 2$

17. If $(x + y + z = 0)$, then what is $(x + y)(y + z)(z + x)$ equal to?

- (a) $-xyz$
(b) $x^2 + y^2 + z^3$
(c) $x^3 + y^3 + z^3 + 3xyz$
(d) xyz

18. If $2x^2 \cos 60^\circ - 4 \cot^2 45^\circ - 2 \tan 60^\circ = 0$, then what is the value of x ?

- (a) 2 (b) 3
(c) $\sqrt{3} - 1$ (d) $\sqrt{3} + 1$

19. If $\sin \theta + \operatorname{cosec} \theta = 2$, then what is the value of $\sin^4 \theta + \operatorname{cosec}^4 \theta$?

- (a) 2 (b) 2^2
(c) 2^3 (d) 1

20. What is the expression :

$$(\sin^4 x - \cos^4 x + 1) \operatorname{cosec}^2 x \text{ equal to?}$$

- (a) 1 (b) 2
(c) 0 (d) -1

DIRECTIONS (Q. 21-23) : Study the following Pie-chart carefully and answer the questions given below.

Survey conducted on 10500 people to find out various Professionals in the town and percentage of Female Professionals amongst them

Various Professionals = 10500

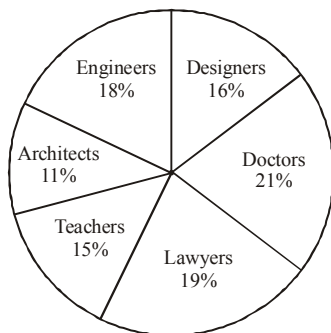

Percentage of Female Professionals

Doctors	20%
Engineers	60%
Architects	40%
Teachers	80%
Lawyers	40%
Designers	35%

21. What is the difference between the total number of male and female professionals in the town ?

- (a) 1284 (b) 1134
(c) 1054 (d) 1164

22. Female Doctors are what per cent of the female Teachers in the town?

- (a) 42 (b) 28
(c) 15 (d) 35

23. What is the ratio of the number of male Architects to the number of male Teachers in the town ?

- (a) 11 : 5 (b) 3 : 2
(c) 5 : 11 (d) 2 : 3

24. The ratio of the length and the breadth of a rectangle is 4 : 3 and the area of the rectangle is 1728 sq cm. What is the ratio of the breadth and the area of the rectangle ?

- (a) 1 : 38 (b) 1 : 24 (c) 1 : 42 (d) 1 : 48

25. A person has four iron bars whose lengths are 24 m, 36 m, 48 m and 72 m respectively. This person wants to cut pieces of same length from each of four bars. What is the least number of total pieces if he is to cut without any wastage?

- (a) 10 (b) 15 (c) 20 (d) 25

26. The sum of first 20 odd natural numbers is equal to :

- (a) 210 (b) 300 (c) 400 (d) 420

27. $\sqrt{24^4} + 224 = ? \times 20^2$

- (a) 20 (b) 4 (c) 2 (d) 16

28. The HCF and LCM of two numbers are 44 and 264 respectively. If the first number is divided by 2, the quotient is 44. What is the other number?

- (a) 108 (b) 44
(c) 124 (d) 132

29. In a class, there are 32 boys and 28 girls. The average age of the boys in the class is 14 yr and the average age of the girls in the class is 13 yr. What is the average age of the whole class ? (Rounded off to two digits after decimal)

- (a) 13.50 (b) 13.53
(c) 12.51 (d) 13.42

30. A man sold two watches for Rs 1000 each. On one he gains 25% and on the other 20% loss. Find how much % does he gain or lose in the whole transaction?
- (a) $\frac{100}{41}$ % loss
 (b) $\frac{100}{41}$ % gain
 (c) No gain, no loss
 (d) Cannot be determined
31. Sarita started a boutique investing an amount of ₹ 50,000. Six months later Neeta joined her with an amount of ₹ 80,000. At the end of one year they earned a profit of ₹ 18,000. What is Sarita's share in the profit?
- (a) ₹ 9000 (b) ₹ 8000
 (c) ₹ 12000 (d) ₹ 10000
32. A man can do a piece of work in 10 days but with the assistance of his son, the work is done in 8 days. In how many days, his son alone can do the same piece of work?
- (a) 15 days (b) 22 days
 (c) 30 days (d) 40 days
33. A man is walking at a speed of 10 km per hour. After every kilometre, he takes rest for 5 minutes. How much time will he take to cover a distance of 5 kilometres?
- (a) 48 min. (b) 50 min.
 (c) 45 min. (d) 55 min.
34. A cylindrical bucket of height 36 cm and radius 21 cm is filled with sand. The bucket is emptied on the ground and a conical heap of sand is formed, the height of the heap being 12 cm. The radius of the heap at the base is :
- (a) 63 cm (b) 53 cm
 (c) 56 cm (d) 66 cm
35. By selling 66 metres of cloth a man loses the selling price of 22 metres. Find the loss per cent.
- (a) 20% (b) 25%
 (c) 30% (d) 35%
36. 2 men and 3 boys can do a piece of work in 10 days while 3 men and 2 boys can do the same work in 8 days. In how many days can 2 men and 1 boy to the work ?
- (a) $12\frac{1}{2}$ days (b) $11\frac{1}{2}$ days
 (c) $15\frac{1}{2}$ days (d) $13\frac{1}{2}$ days
37. A car covers 420 km with a constant speed. If its speed were 10 km/h more it would have taken one hour less to cover the distance. Find the speed of the car.
- (a) 60 km/h (b) 55 km/h
 (c) 50 km/h (d) 48 km/h
38. If $\frac{x}{2y} = \frac{6}{7}$, the value of $\frac{x-y}{x+y} \cdot \frac{14}{19}$ is :
- (a) $\frac{13}{19}$ (b) $\frac{15}{19}$
 (c) 1 (d) $1\frac{1}{19}$
39. If for two real constants a and b, the expression $ax^3 + 3x^2 - 8x + b$ is exactly divisible by $(x+2)$ and $(x-2)$, then
- (a) $a=a, b=12$ (b) $a=12, b=2$
 (c) $a=2, b=-12$ (d) $a=-2, b=12$
40. The value of $(1 + \sec 20^\circ + \cot 70^\circ)(1 - \operatorname{cosec} 20^\circ + \tan 70^\circ)$ is
- (a) -1 (b) 2
 (c) 1 (d) 0

GENERAL INTELLIGENCE & REASONING

DIRECTIONS (Qs. 41-42) : In questions, select the related word/letters/number from given alternatives.

41. ACE : BDF :: GIK : ?
- (a) HJL (b) AXP
 (c) CFG (d) GFC
42. hive : bee :: eyrie : ?
- (a) Pigeon (b) Sparrow
 (c) Parrot (d) Eagle

DIRECTIONS (Qs. 43-44) : In questions, find the odd word/letters/number pair from the given alternatives.

43. (a) vwqp (b) yxmn
 (c) gflk (d) cbrs
44. (a) (324,18) (b) (441,72)
 (c) (117,81) (d) (186,14)
45. Which one of the given responses would be a meaningful order of the following words?
1. Sowing 2. Tilling
 3. Reaping 4. Weeding
- (a) 3, 1, 2, 4 (b) 2, 1, 4, 3
 (c) 1, 2, 4, 3 (d) 1, 3, 2, 4

DIRECTIONS (Qs. 46-47) : In questions below, a series is given with one term missing. Choose the correct alternative from the given ones that will complete the series.

46. -1, 0, ?, 8, 15, 24
- (a) 4 (b) 3
 (c) 2 (d) 1

47. 24, 35, 20, 31, 16, 27, __, __
 (a) 9, 9 (b) 5, 30
 (c) 8, 25 (d) 12, 23
48. In a language FIFTY is written as CACTY, CAR as POL, TAR as TOL, how can TARIFF be written in that language?
 (a) TOEFEL (b) TOEFDD
 (c) TOLADD (d) TOLACC
49. Which one set of letters when sequentially placed at the gaps in the given letter series shall complete it?
 rx _ sx _ z _ txy _ _ yz
 (a) yy r x s (b) y y s x r
 (c) y y r s x (d) y y x r s
50. A is in the east of B which is in the North of C. If D is in the South of C., then in which direction of A, is D.
 (a) North – West (b) South
 (c) East – East (d) South–West
51. Four positions of a dice are given below, Identify the number at the bottom then top is 6.

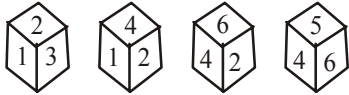

- (a) 1 (b) 3
 (c) 4 (d) 5
52. Introducing a boy, a girl said, "He is the son of the daughter of the father of my uncle." How is the boy related to the girl?
 (a) Brother (b) Nephew
 (c) Uncle (d) Son-in-law
53. In the following figure, the boys who are cricketer and sober are indicated by which number ?

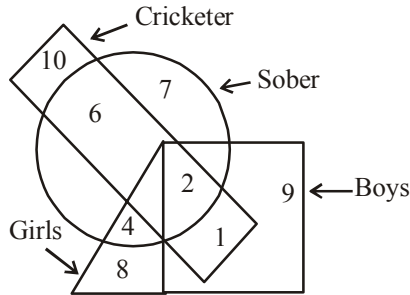

- (a) 6 (b) 5
 (c) 4 (d) 2
54. Some equations are solved on the basis of a certain system. Find the correct answer for the unsolved equation on that basis.
 $5 * 6 = 35, 8 * 4 = 28, 6 * 8 = ?$
 (a) 46 (b) 34
 (c) 23 (d) 38

DIRECTIONS (55-56) : In each of the following questions, select the missing number from the given responses.

55.

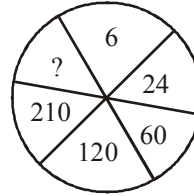

- (a) 330 (b) 336
 (c) 428 (d) 420
56. $\begin{matrix} 12 & 15 & 16 \\ 03 & 04 & 05 \\ 04 & 06 & 04 \\ 40 & 66 & ? \end{matrix}$
 (a) 104 (b) 320
 (c) 25 (d) 84
57. Six girls are standing in such a way that they form a circle, facing the centre. Subbu is to the left of Pappu, Revathi is between Subbu and Nisha, Aruna is between Pappu and Keertana. Who is to the left of Pappu ?
 (a) Keertana (b) Nisha
 (c) Aruna (d) Subbu

DIRECTIONS (Qs. 58) : In the following question, two statements are given followed by four conclusions I, II, III and IV. You have to consider the statements to be true even if they seem to be at variance from commonly known facts. You have to decide which of the given conclusions, if any follow from the given statements.

58. Statements :

- I. Some cats are dogs.
 II. No dog is a toy.

Conclusions :

- I. Some dogs are cats.
 II. Some toys are cats.
 III. Some cats are not toys.
 IV. All toys are cats.
 (a) Only Conclusions I and either II or III.
 (b) Only Conclusions II and III follow
 (c) Only Conclusions I and II follow
 (d) Only Conclusion I follows
59. At present, the ratio between the ages of Arun and Deepak is 4 : 3. After 6 years, Arun's age will be 26 years. What is the age of Deepak at present?
 (a) 15 years (b) 19 years
 (c) 24 years (d) 12 years

DIRECTION (Qs. 60): In Question which one of the following diagrams represents the correct relationship among :

60. Lion, Fox and Carnivorous

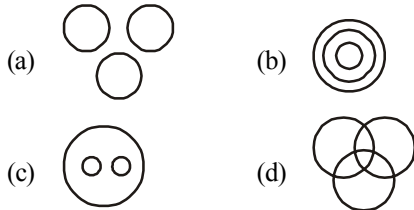

DIRECTIONS (61-62) : In each of the following questions, if a mirror is placed on the line AB, then which of the answer figures is the right image of the given figure?

61. Question Figure:

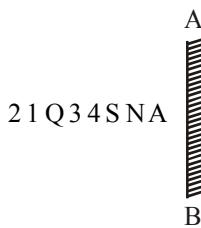

Answer Figures:

- (a) AN24EQ1Q
- (b) AN24EQ1Q
- (c) 21Q34SNA
- (d) ANS4EQ12

62. Question Figure:

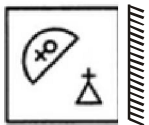

Answer Figures:

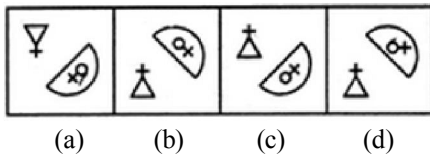

63. How many triangles are there in the following square ?

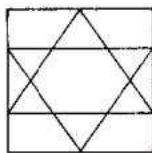

- (a) 7
- (b) 12
- (c) 6
- (d) 9

64. Find out the alternative figure which contains figure (X) as its part.

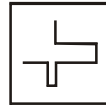

(X)

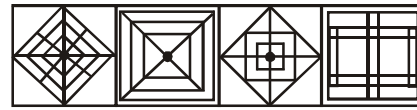

(a) (b) (c) (d)

DIRECTION (Qs. 65) : A word is represented by only one set of numbers as given in any one of the alternatives. The sets of numbers given in the alternatives are represented by two classes of alphabets as in two matrices given below. The columns and rows of Matrix I are numbered from 0 to 4 and that of Matrix II are numbered from 5 to 9. A letter from these matrices can be represented first by its row and next by its column e.g., 'E' can be represented by 01, 13 etc., and 'L' can be represented by 56, 77 etc. Similarly, you have to identify the set for the word given in each question.

65.

Matrix I

	0	1	2	3	4
0	Z	M	G	R	C
1	J	L	D	B	G
2	M	B	C	M	H
3	R	L	N	G	I
4	B	D	M	R	J

Matrix II

	5	6	7	8	9
5	X	K	T	E	S
6	Q	A	U	X	P
7	U	V	O	W	E
8	T	Y	A	F	U
9	O	O	E	V	A

LANE

- (a) 11, 66, 33, 96
- (b) 31, 87, 32, 97
- (c) 31, 66, 33, 97
- (d) 11, 67, 32, 97

66. 'Talk' is related to 'Speak' in a certain way. Similarly, 'Honest' is related to 'Truthful'. Following the same logic, 'Listen' is related to '.....'.

- (a) Music
- (b) Ears
- (c) Hear
- (d) Ignore

67. Three of the following are alike in a certain way and form a group. Find the odd one out.
 (a) Bird (b) Insect
 (c) Aeroplane (d) Kite
68. If the 1st half of the English alphabet is written in the backward order, then find the 15th letter to the left of 20th letter from left.
 (a) H (b) I
 (c) Y (d) X
69. Select the combination of numbers so that letters arranged accordingly will form a meaningful word.
 R A C E T
 1 2 3 4 5
 (a) 1,2,3,4,5 (b) 3,2,1,4,5
 (c) 5,2,3,4,1 (d) 5,1,2,3,4
70. Veena walked 5m towards north, took a left turn and walked 7 m. She took a left turn again and walked 8m before taking a left turn and walking 7 m. She then took a final left turn and walked 1 m before stopping. How far is Veena from the starting point?
 (a) 3m (b) 6m (c) 4m (d) 2m
71. A, B, C, D and E each has different heights. D is only shorter than B. E is shorter than A and C. Who is the shortest of them?
 (a) E (b) A
 (c) C (d) Data inadequate
72. ENGLAND is written as 1234526 and FRANCE as 785291. How will GREECE be written in this coding scheme?
 (a) 381191 (b) 381911
 (c) 394132 (d) 562134
73. In the following diagram, the triangle represents doctors, the circle represents players and the rectangle represents singers. Which region represents doctors who are singers but not players?

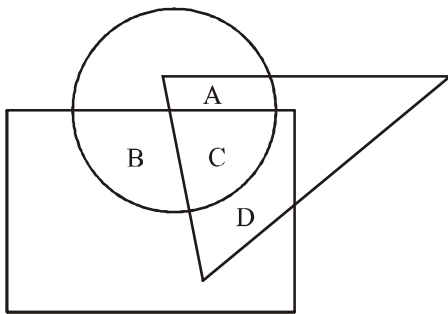

- (a) A (b) B
 (c) C (d) D

74. Pointing to a photograph Arun said, 'She is the mother of my brother's son's wife's daughter.' How is Arun related to the lady's husband?
 (a) Uncle (b) Daughter-in-law
 (c) Cousin (d) Brother
75. How many such pairs of letters are there in the word 'KINDNESS' each of which have as many letters between them in word as in the alphabets?
 (a) Nil (b) One
 (c) Two (d) Three

DIRECTIONS (Qs. 76-77) : In each of the questions given below a group of digits is given followed by four combinations of letters/symbols. You have to find out which of the four combinations correctly represents the group of digits based on the letter/symbol codes and the conditions given below. If none of the four combinations represents the group of digits correctly, give (e) i.e. "None of these" as the answer.

Digit:	3	9	6	2	8	7	5	4	1
Symbol :	K	T	\$	F	H	#	%	D	M

Conditions for the coding the group of digits:

- If the first digit is odd and last digit is even, the codes for the first and the last digits are to be interchanged.
 - If the first as well as the last digit is even, both are to be coded by the code for last digit.
 - If the first as well as the last digit is odd, both are to be coded as 'X'.
76. **564923**
 (a) %\$DTFK (b) K\$DTFK
 (c) X\$DTFX (d) K\$DTF%
77. **658247**
 (a) \$%HFD# (b) #%HFDS
 (c) %\$HFD# (d) #%HFDS

DIRECTIONS (Qs. 78-80) : Study the following information carefully to answer the questions given below.

P, T, V, R, M, D, K and W are sitting around a circular table facing the centre. V is second to the left of T. T is fourth to the right of M. D and P are not immediate neighbours of T. D is third to the right of P. W is not an immediate neighbour of P. P is to the immediate left of K.

78. Who is second to the left of K?
 (a) P (b) R
 (c) M (d) W
79. Who is to the immediate left of V?
 (a) D (b) M
 (c) W (d) Data inadequate
80. Who is the third to the right of V?
 (a) T (b) K
 (c) P (d) None of these

GENERAL AWARENESS

81. Which one of the following is a programme that converts high level language to machine language?
 (a) Linker (b) Assembler
 (c) Interpreter (d) Compiler
82. Classification of an enterprise into public or private sector is based on
 (a) number of employees in the enterprise
 (b) ownership of assets of the enterprise
 (c) employment conditions for workers in the enterprise
 (d) nature of products manufactured by the enterprise
83. Which one of the following glands produces the growth hormone (somatotrophin)?
 (a) Adrenal (b) Pancreas
 (c) Pituitary (d) Thyroid
84. Who among the following was elected as the President of All India Khilafat Conference met at Delhi in 1919?
 (a) Motilal Nehru (b) Mahatma Gandhi
 (c) M A Jinnah (d) Shaukat Ali
85. Which one of the following Indian states does not have a common international border with Bangladesh?
 (a) Manipur (b) Paschim Banga
 (c) Tripura (d) Asom
86. Who among the following is the author of the book. 'The Namesake'?
 (a) Arundhati Roy (b) Amitava Ghosh
 (c) Jhumpa Lahiri (d) Kiran Desai
87. Who among the following was not a member of the Constituent Assembly?
 (a) Sardar Vallabhbhai Patel
 (b) Acharya JB Kriplani
 (c) Lok Nayak Jayprakash
 (d) K M Munshi
88. Carbon dioxide is called a greenhouse gas because
 (a) its concentration remains always higher than other gases
 (b) it is used in photosynthesis
 (c) it absorbs infrared radiation .
 (d) it emits visible radiation
89. Laser is a device to produce
 (a) a beam of white light
 (b) coherent light
 (c) microwaves
 (d) X-rays
90. In the human body, Cowper's glands form a part of which one of the following system?
 (a) Digestive system
 (b) Endocrine system
 (c) Reproductive system
 (d) Nervous system
91. Mist is a result of which one of the following
 (a) Condensation (b) Evaporation
 (c) Sublimation (d) Saturation
92. 'Dyarchy' was first introduced in India under
 (a) Morley-Minto reforms
 (b) Montford reforms
 (c) Simon Commission plan
 (d) Government of India Act, 1935
93. When Lord Mountbatten became the first Governor-General of India, who among the following became the Governor-General for Pakistan?
 (a) Lord Mountbatten
 (b) Muhammad Ali Jinnah
 (c) Liaquat Ali Khan
 (d) Shaukat Ali
94. Fiscal Policy in India is formulated by
 (a) the Reserve Bank of India
 (b) the Planning Commission
 (c) the Finance Ministry
 (d) the Securities and Exchange Board of India
95. Fat can be separated from milk in a cream separation because of
 (a) cohesive force (b) gravitational force
 (c) centrifugal force (d) centripetal force
96. The average fixed cost curve will always be
 (a) a rectangular hyperbola
 (b) a downward sloping convex to the origin curve
 (c) a downward sloping straight line
 (d) a U-shaped curve
97. Malaria in the human body is caused by which one of the following organisms?
 (a) Bacteria (b) Virus
 (c) Mosquito (d) Protozoan
98. The focal length of convex lens is
 (a) the same for all colours
 (b) shorter for blue light than for red
 (c) shorter for red light than for blue
 (d) maximum for yellow light
99. The Name of Ram Prasad Bismil is associated with
 (a) Kanpur Conspiracy Case
 (b) Alipore Conspiracy Case
 (c) Kakori Conspiracy Case
 (d) Meerut Conspiracy Case

100. The Indian Research Station 'Himadri' is located at
 (a) Siachen (b) Darjeeling
 (c) Arctic Region (d) Antarctica
101. What is the theme of the first-ever "National Yoga Olympiad", which has been organized by the NCERT?
 (a) Yoga for Peace and Dhyana
 (b) Yoga for Health and Harmony
 (c) Yoga for Kriya and Harmony
 (d) Yoga for Emotional and Mental development
102. Mohammad Shahid is associated with which sports?
 (a) Hockey (b) Badminton
 (c) Wrestling (d) Boxing
103. KG Subramanyan, who passes away recently, was a famous personality of which field?
 (a) Art (b) Journalism
 (c) Sports (d) Politics
104. Who has won the 2016 wins Iceland's presidential election?
 (a) David Oddsson
 (b) Olafur Ragnar Grimsson
 (c) Gudni Johannesson
 (d) Andri Snær Magnason
105. Which of the following countries has become the newest member of the Missile Technology Control Regime (MTCR)?
 (a) Canada (b) India
 (c) Brazil (d) Poland
106. What is the keyboard short-cut for new slide?
 (a) Ctrl + M (b) Ctrl + N
 (c) Ctrl + Shift + N (d) Ctrl + S
107. Vertical space between lines of text in document is called
 (a) Double space (b) Line gap
 (c) Single space (d) Line spacing
108. Full form of CD-RW is
 (a) Compact Drum, Read, Write
 (b) Compact Diskette, Read, Write
 (c) Compact Disc, Read-only then Write
 (d) Compact Disc-Rewritable
109. Password makes users capable
 (a) To enter into system quickly
 (b) To use time efficiently
 (c) To retain the secrecy of files
 (d) To make file structure simple
110. Files deleted from hard disc are sent to
 (a) Dustbin (b) Floppy Disc
 (c) Clip board (d) Recycle bin
111. Fairy Queen, the world's oldest steam locomotive in regular operation, plies between New Delhi and -
 (a) Shimla (b) Alwar
 (c) Kalka (d) Gwalior
112. Who of the following was the first Railway Minister of independent India?
 (a) John Mathai
 (b) Lal Bahadur Shastri
 (c) Jawaharlal Nehru
 (d) Shanmugham Shetty
113. Shatabdi Express trains were introduced in 1989 to commemorate the 100th anniversary of which of the following personalities?
 (a) Swami Vivekanand
 (b) Mahatma Gandhi
 (c) Jawaharlal Nehru
 (d) Rabindranath Tagore
114. Who was the Governor General of India when Railways were first introduced in India?
 (a) Lord Canning
 (b) Lord Dalhousie
 (c) Lord William Bentick
 (d) Lord Ripon
115. In which city is the Wheel and Axle Plant of the Indian Railways located?
 (a) Kapurthala (b) Varanasi
 (c) Bangalore (d) Rae Bareilly
116. Who won the 2016 World Chess Championship?
 (a) Sergey Karjakin
 (b) Garry Kasparov
 (c) Viswanathan Anand
 (d) Magnus Carlsen
117. What was the theme of the 2016 World AIDS Day?
 (a) Getting to zero
 (b) The time to act is now
 (c) Hands up for #HIVprevention
 (d) None of the above
118. The UNESCO recently added rumba dance to its coveted list of Intangible Cultural Heritage. The dance belongs to which of the following countries?
 (a) Brazil (b) Colombia
 (c) Cuba (d) Argentina
119. Which words was picked by Dictionary.com as the Word of the Year for 2016?
 (a) Post Truth (b) Xenophobia
 (c) Chatbot (d) Adulthood
120. Indian railways will introduced which system to check collisions between tracks to reduce train accidents by keeping a record of the track maintenance and will also provide better visibility during foggy days?
 (a) Rail Saver (b) Tri-Netra
 (c) i-Netra (d) Track Saver

Hints & Explanations

1. (d)
- $$\begin{aligned} & \sqrt{7.84} + \sqrt{0.0784} + \sqrt{0.000784} + \sqrt{0.00000784} \\ &= \sqrt{\frac{784}{100}} + \sqrt{\frac{784}{10000}} + \sqrt{\frac{784}{1000000}} + \sqrt{\frac{784}{100000000}} \\ &= \frac{28}{10} + \frac{28}{100} + \frac{28}{1000} + \frac{28}{10000} \\ &= 2.8 + 0.28 + 0.028 + 0.0028 = 3.1108 \end{aligned}$$
2. (d) On taking option (d).
The reverse digit of 451 is 154.
Now, $154 + 297 = 451$ is equal to the original number.
3. (a) 40% of 50% of $\frac{3}{4}$ of 3200
- $$= \frac{4}{10} \times \frac{5}{10} \times \frac{3}{4} \times 3200 = 4 \times 5 \times 3 \times 8 = 480$$
4. (b) There are $7 + 5 = 12$ balls in the bag and the number of ways in which 4 balls can be drawn is ${}^{12}C_4$ and the number of ways of drawing 4 black balls (out of seven) is 7C_4 .
Hence, P(4 black balls)
- $$\frac{{}^7C_4}{{}^{12}C_4} = \frac{7 \cdot 6 \cdot 5 \cdot 4}{1 \cdot 2 \cdot 3 \cdot 4} \times \frac{1 \cdot 2 \cdot 3 \cdot 4}{12 \cdot 11 \cdot 10 \cdot 9} = \frac{7}{99}$$
- Thus the odds against the event 'all black balls' are
- $$\left(1 - \frac{7}{99}\right) : \frac{7}{99} \text{ i.e., } \frac{92}{99} : \frac{7}{99} \text{ or } 92 : 7$$
5. (c) Let the cost price of the watch = ₹x
After 40% marked price and 10% discount
- $$= x \times \frac{90}{100} \times \frac{140}{100} = \frac{126x}{100}$$
- $$\text{Profit} = \frac{126x}{100} - x = \frac{26x}{100}$$
- According to question,
Pay 10% tax on profit
- $$= \frac{26x}{100} \times \frac{90}{100} = 468$$
- $$x = \frac{468 \times 100 \times 100}{26 \times 90} = ₹2000$$
6. (b) Let the number of men be n
- | Men | Days |
|--|---|
| $\begin{matrix} 42 \\ n \end{matrix} \downarrow$ | $\begin{matrix} 25 \\ 14 \end{matrix} \uparrow$ |
- $$\therefore \frac{n}{42} = \frac{25}{14} \Rightarrow n = 75$$
7. (d) Volume of wire = $\pi r^2 h$
- New radius of the wire = $\frac{r \times 90}{100} = \frac{9r}{10}$
Let new length of the wire be L.
 \therefore Volume of new wire
- $$= \pi \left(\frac{9r}{10}\right)^2 \times L = \frac{81}{100} \pi r^2 L$$
- According to question,
- $$\pi r^2 h = \frac{81}{100} \pi r^2 L \Rightarrow L = \frac{100}{81} h$$
- Increase in length = $\frac{100}{81} h - h = \frac{19}{81} h$
- $$\text{Percent increase} = \frac{19/81h}{h} \times 100\% = 23.46\%$$
- $$= 23\% \text{ (approx)}$$
8. (c) Let the observation mean = x
 \therefore Sum of 50 observations = 50x
According to question,
- $$\therefore \frac{50x - 45}{49} = x$$
- $$\Rightarrow 50x - 45 = 49x$$
- $$\therefore x = 45$$
9. (b) Interest earned in 1st half of a year
- $$= 20,000 \times \frac{1}{2} \times \frac{20}{100} = 2000$$
- Similarly, During second half, interest earned = 2200
During second year, interest earned = 4840 (Note : Interest is calculated as compound)
Total interest earned at the end of two years = $2000 + 220 + 4840 = ₹9040$.
10. (a) Since, area of circle = $4\pi \text{ cm}^2$ (given)
 $\Rightarrow \pi r^2 = 4\pi \Rightarrow r = 2 \text{ cm}$

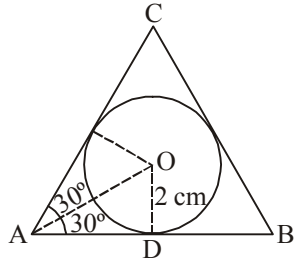

In $\triangle OAD$, $\tan 30^\circ = \frac{OD}{AD} \Rightarrow AD = 2\sqrt{3}$ cm

Now, $AB = 2AD = 4\sqrt{3}$ cm
 \therefore Area of equilateral $\triangle ABC = \frac{\sqrt{3}}{4}(AB)^2 = \frac{\sqrt{3}}{4}(4\sqrt{3})^2 = 12\sqrt{3}$ cm²

11. (c)

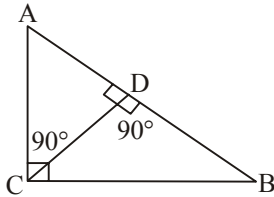

In $\triangle ABC$
 $CD \perp AB$
 and $AB \times CD = CA \times CB$... (i)
 In $\triangle CDB$
 $BC^2 = BD^2 + CD^2$... (ii)
 $CD^2 = BC^2 - BD^2$
 From eq. (i) and (ii)
 $\frac{1}{CD^2} = \frac{1}{BC^2} - \frac{1}{CA^2}$

12. (b) We draw a line segment parallel to BF .

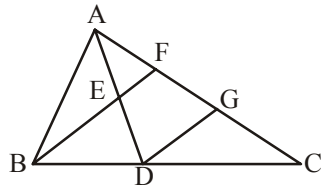

In $\triangle ADG$
 BF or $EF \parallel DG$ and $AE = ED$ (since, E is mid-point of AD)
 $\therefore AF = GC$... (i)
 Similarly, in $\triangle BCF$,
 $DG \parallel BF$ and $BD = DC$
 $FG = GC$... (ii)

From Eqs. (i) and (ii),

$$CF = \frac{2}{3} AC$$

13. (c) Three vertices can be selected in 6C_3 ways.

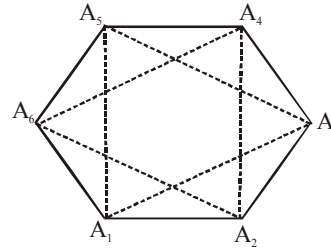

The only equilateral triangles possible are $A_1A_3A_5$ and $A_2A_4A_6$

$$P = \frac{2}{{}^6C_3} = \frac{2}{20} = \frac{1}{10}$$

14. (a)

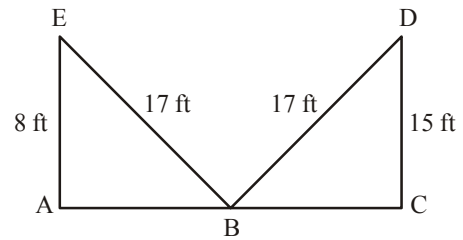

In $\triangle ABE$,
 $BE^2 = AE^2 + AB^2 \Rightarrow AB^2 = 17^2 - 8^2$
 or $AB^2 = 289 - 64 = 225 \Rightarrow AB = 15$ ft
 In $\triangle BCD$,
 $BD^2 = BC^2 + CD^2 \Rightarrow BC^2 = 17^2 - 15^2$
 $= 289 - 225 = 64$
 $\Rightarrow BC = 8$ ft
 \therefore Width of the street = $AB + BC = 15 + 8 = 23$ ft

15. (d)

$$\frac{1}{1+\sqrt{2}} + \frac{1}{\sqrt{2}+\sqrt{3}} + \dots + \frac{1}{\sqrt{15}+\sqrt{16}}$$

(on rationalisation)

$$= \frac{1-\sqrt{2}}{1-2} + \frac{\sqrt{2}-\sqrt{3}}{2-3} + \dots + \frac{\sqrt{15}-\sqrt{16}}{15-16}$$

$$= -1(1-\sqrt{2} + \sqrt{2}-\sqrt{3} + \dots + \sqrt{15}-\sqrt{16})$$

$$= -1(1-4) = 3$$

16. (d) Given, $x + \frac{1}{x} = p$

$$\Rightarrow \left(x + \frac{1}{x}\right)^2 = p^2$$

$$\Rightarrow x^2 + \frac{1}{x^2} + 2 = p^2$$

$$\Rightarrow x^2 + \frac{1}{x^2} = p^2 - 2 \quad \dots (i)$$

$$\Rightarrow \left(x^2 + \frac{1}{x^2}\right)^3 = (p^2 - 2)^3$$

$$\Rightarrow x^6 + \frac{1}{x^6} + 3\left(x^2 + \frac{1}{x^2}\right) = p^6 - 8 - 6p^2(p^2 - 2)$$

$$\Rightarrow x^6 + \frac{1}{x^6} + 3(p^2 - 2) = p^6 - 8 - 6p^4 + 12p^2$$

[from equation (i)]

$$\Rightarrow x^6 + \frac{1}{x^6} = p^6 - 6p^4 + 9p^2 - 2$$

17. (a) Given, $x + y + z = 0$

$$\therefore (x + y)(y + z)(z + x) = (-z)(-x)(-y) = -xyz$$

18. (d) Given, $2x^2 \cos 60^\circ - 4 \cot^2 45^\circ - 2 \tan 60^\circ = \theta$

$$\Rightarrow 2x^2 \times \frac{1}{2} - 4(1)^2 - 2 \times \sqrt{3} = 0$$

$$\Rightarrow x^2 - 4 - 2\sqrt{3} = 0$$

$$\Rightarrow x^2 = 4 + 2\sqrt{3}$$

$$\Rightarrow x^2 = 3 + 1 + 2\sqrt{3}$$

$$\Rightarrow x^2 = (\sqrt{3})^2 + (1)^2 + 2\sqrt{3} \cdot 1$$

$$\Rightarrow x^2 = (\sqrt{3} + 1)^2$$

$$\Rightarrow x = \sqrt{3} + 1$$

19. (d) $\sin \theta + \operatorname{cosec} \theta = 2$

$$\Rightarrow \sin \theta + \frac{1}{\sin \theta} = 2$$

$$\Rightarrow \sin^2 \theta - 2 \sin \theta + 1 = 0$$

$$\Rightarrow (\sin \theta - 1)^2 = 0$$

$$\Rightarrow \sin \theta = 1$$

$$\Rightarrow \sin \theta = \sin 90^\circ$$

$$\Rightarrow \theta = 90^\circ$$

$$\therefore \sin^4 \theta + \cos^4 \theta = \sin^4 90^\circ + \cos^4 90^\circ = 1 + 0 = 1$$

Alternate Method

Given that

$$\sin \theta + \operatorname{cosec} \theta = 2$$

Now, put $-\theta = 90^\circ$

$$1 + 1 = 2$$

Similarly put $\theta = -90^\circ$

$$\begin{aligned} \sin^4 \theta + \cos^4 \theta &= \sin^4 90^\circ + \cos^4 90^\circ \\ &= 1 + 0 = 1 \end{aligned}$$

20. (b) $(\sin^4 x - \cos^4 x + 1) \operatorname{cosec}^2 x$
 $= \{(\sin^2 x - \cos^2 x)(\sin^2 x + \cos^2 x) + 1\} \operatorname{cosec}^2 x$
 $[(\because a^2 - b^2 = (a + b)(a - b))]$
 $= (\sin^2 x - \cos^2 x + 1) \operatorname{cosec}^2 x$
 $= (\sin^2 x + \sin^2 x) \operatorname{cosec}^2 x$
 $(\because 1 - \cos^2 x = \sin^2 x)$
 $= 2 \sin^2 x \cdot \frac{1}{\sin^2 x} = 2$

21. (d) % of female professionals =
 $= [20\% \text{ of } 21\% + 60\% \text{ of } 18\% + 40\% \text{ of } 11\%$
 $+ 80\% \text{ of } 15\% + 40\% \text{ of } 19\% + 35\% \text{ of } 16\%]$

$$\frac{1}{100} [420 + 1080 + 440 + 1200 + 760 + 560]\%$$

$$= \frac{4460}{100}\% = 44.6\%$$

\therefore % of male professionals

$$= 100\% - 44.6\% = 55.4\%$$

\therefore Required difference

$$= (55.4 - 44.6)\% \text{ of } 10500$$

$$= 10.8\% \text{ of } 10500 = 10.8 \times 105 = 1134$$

22. (d) Required %

$$= \frac{20\% \text{ of } 21}{89\% \text{ of } 15} \times 100\% \approx \frac{20 \times 21}{80 \times 15} \times 100\%$$

$$\frac{420}{12} \approx 35\%$$

23. (a) Required ratio = $\frac{60 \times 11}{20 \times 15}$ 11 : 5

24. (d) $(4x)(3x) = 1728$

$$\Rightarrow x^2 = 144 \therefore x = 12$$

$$\Rightarrow \text{length} = 48; \text{breadth} = 36$$

$$\therefore \text{Required ratio} = \frac{36}{36 \times 48} \quad 1 : 48$$

25. (b) $24 = 12 \times 2$,
 $36 = 12 \times 3$,
 $48 = 12 \times 4$,
and $72 = 12 \times 6$
 \therefore HCF (24, 36, 48, 72) = 12
Total pieces = $2 + 3 + 4 + 6 = 15$
26. (c) Series of first 20 odd natural numbers is an arithmetic progression with 1 as the first term and the common difference 2. Sum of n terms in arithmetic progression is given by.
 $S_n = \frac{1}{2}n[2a + (n-1)d]$
Where a : First term
 d : common difference
 $\therefore S_{20} = \frac{1}{2} \times 20[(2 \times 1) + (20-1) \times 2]$
 $= 10[2 + 38] = 10 \times 40 = 400$
27. (c) $\sqrt{24^4 + 224} = ? \times 20^2$
 $\Rightarrow \frac{(24)^2 + 224}{20^2} ? \Rightarrow ? = \frac{800}{400} = 2$
28. (d) The first number = $2 \times 44 = 88$
 \therefore The second number = $\frac{\text{HCF} \times \text{LCM}}{88}$
 $= \frac{44 \times 264}{88} = 132$
29. (b) Average age of the whole class
 $= \frac{32 \times 14 + 28 \times 13}{32 + 28} = \frac{448 + 364}{60}$
 $= \frac{812}{60} = 13.53 \text{ yr}$
30. (b) When $S_1 = S_2$, then overall % gain or % loss
 $= \left[100 - \frac{2(100 + x_1)(100 - x_2)}{(100 + x_1) + (100 - x_2)} \right] \%$
 $= \left(100 - \frac{2(125)(80)}{(125) + (80)} \right) \%$
 $= \left(100 - \frac{2 \times 125 \times 80}{205} \right) \%$
 $= \frac{100}{41} \%$ gain (\because it is +ve)
31. (d) Ratio of capital = $50000 \times 12 : 80000 \times 6 = 5 : 4$
 \therefore Sarita's share = $\frac{18000 \times 5}{(5+4)} = ₹ 10000$
32. (d) (Man + Son)'s one day's work = $\frac{1}{8}$
Man's one day's work = $\frac{1}{10}$
 \Rightarrow Son's one day's work = $\frac{1}{8} - \frac{1}{10} = \frac{1}{40}$
 \therefore Son can do it in 40 days.
33. (b) Rest time = Number of rest \times Time for each rest
 $= 4 \times 5 = 20$ minutes
Total time to cover 5 km
 $= \left(\frac{5}{10} \times 60 \right) \text{ minutes} + 20 \text{ minutes} = 50 \text{ minutes.}$
34. (a) Volume of the bucket = volume of the sand emptied
Volume of sand = $\pi(21)^2 \times 36$
Let r be the radius of the conical heap.
Then, $\frac{1}{3}\pi r^2 \times 12 = \pi(21)^2 \times 36$
or $r^2 = (21)^2 \times 9$ or $r = 21 \times 3$
 $= 63 \text{ cm}$
35. (b) Loss = C.P. of 66 metres – S.P. of 66 metres
 $=$ S.P. of 22 metres
 \Rightarrow C.P. of 66 metres = S.P. of 88 metres
% loss = $\frac{\text{loss}}{\text{C.P. of 66 metres}} \times 100$
 $= \frac{\text{S.P. of 22 metres}}{\text{C.P. of 66 metres}} \times 100$
 $= \frac{\text{S.P. of 22 metres}}{\text{S.P. of 88 metres}} \times 100$
 $= \frac{22}{88} \times 100 = 25\%$
36. (a) Let 1 man's 1 days' work = x & 1 boy's 1 day's work = y
Then, $2x + 3y = \frac{1}{10}$ and $3x + 2y = \frac{1}{8}$
Solving, we get : $x = \frac{7}{200}$ and $y = \frac{1}{100}$
 \therefore (2 men + 1 boy)'s 1 day's work
 $= \left(2 \times \frac{7}{200} + 1 \times \frac{1}{100} \right) = \frac{16}{200} = \frac{2}{25}$
So, 2 men and 1 boy together can finish the work in $12 \frac{1}{2}$ days.

37. (a) Let the speed of car = S km /h.
 Also, let previous time = t hr. Then,
 $420 = St$... (i)
 Also, $420 = (S + 10)(t - 1)$
 $\Rightarrow 420 = (S + 10)\left(\frac{420}{S} - 1\right)$ [By (i)]
 $\Rightarrow S^2 + 10S - 4200 = 0$
 $\Rightarrow (S + 70)(S - 60) = 0$
 $\Rightarrow S = 60 \text{ km/h}$

38. (c) $\frac{x}{2y} = \frac{6}{7} \Rightarrow \frac{x}{y} = \left(2 \times \frac{6}{7}\right) \frac{12}{7}$
 $\therefore \frac{x-y}{x+y} + \frac{14}{19} = \frac{\frac{12}{7} - 1}{\frac{12}{7} + 1} + \frac{14}{19} = \frac{\frac{5}{7}}{\frac{19}{7}} + \frac{14}{19}$
 $= \left(\frac{5}{7} \times \frac{7}{19}\right) \frac{14}{19} + \frac{5}{19} + \frac{14}{19} = \frac{19}{19} = 1$

39. (c) $P(x) = ax^3 + 3x^2 - 8x + b$
 $\therefore P(-2) = -8a + 12 + 16 + b = 0$
 $\Rightarrow -8a + b + 28 = 0$... (i)
 $\Rightarrow P(2) = 8a + 12 - 16 + b = 2$
 $\Rightarrow 8a + b - 4 = 0$... (ii)
 By equation (i) + (ii)
 $2b + 24 = 0 \Rightarrow b = -\frac{24}{2} = -12$

From equation (i),
 $-8a - 12 + 28 = 0$
 $\Rightarrow -8a = -16 \Rightarrow a = 2$

40. (b) $(1 + \sec 20^\circ + \cot 70^\circ)(1 - \operatorname{cosec} 20^\circ + \tan 70^\circ)$
 $= [1 + \operatorname{cosec} (90^\circ - 20^\circ) + \cot 70^\circ]$
 $[1 - \sec (90^\circ - 70^\circ) + \tan 70^\circ]$
 $= [1 + \operatorname{cosec} 70^\circ + \cot 70^\circ][1 - \sec 70^\circ + \tan 70^\circ]$
 $= \left[1 + \frac{1}{\sin 70^\circ} + \frac{\cos 70^\circ}{\sin 70^\circ}\right]$
 $\left[1 - \frac{1}{\cos 70^\circ} + \frac{\sin 70^\circ}{\cos 70^\circ}\right]$
 $= \frac{(\sin^2 70^\circ + \cos 70^\circ + 1)(\sin 70^\circ + \cos 70^\circ - 1)}{\sin 70^\circ \cos 70^\circ}$
 $= \frac{\sin^2 70^\circ + \cos^2 70^\circ + 2 \sin 70^\circ \cos 70^\circ - 1}{\sin 70^\circ \cos 70^\circ}$
 $= \frac{2 \sin 70^\circ \cos 70^\circ}{\sin 70^\circ \cos 70^\circ}$
 $[\because \sin^2 70^\circ + \cos^2 70^\circ = 1]$
 $= 2$

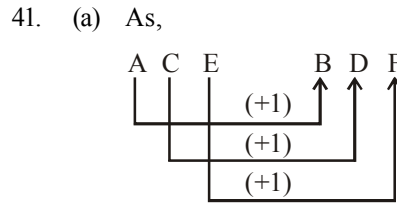

Similarly

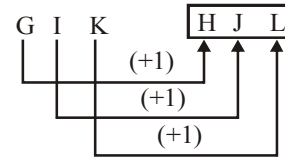

42. (d) A hive is a shelter for bees. Whereas, A eyrie is a large nest of an eagle.

43. (a) $v \xrightarrow{(+1)} w$ $p \xrightarrow{(+1)} q$
 $y \xrightarrow{(-1)} x$ $m \xrightarrow{(+1)} n$
 $g \xrightarrow{(-1)} f$ $k \xrightarrow{(+1)} l$
 $c \xrightarrow{(-1)} b$ $r \xrightarrow{(+1)} s$

44. (a) Except (a), all others are not divisible by 2nd term.

45. (b) Meaning full words

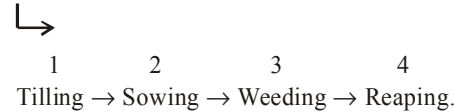

46. (b) $-1 \quad 0 \quad 3 \quad 8 \quad 15 \quad 24$
 $\quad \quad \quad \uparrow \quad \uparrow \quad \uparrow \quad \uparrow \quad \uparrow$
 $\quad \quad \quad +1 \quad +3 \quad +5 \quad +7 \quad +9$

47. (d) There are two numbers series:

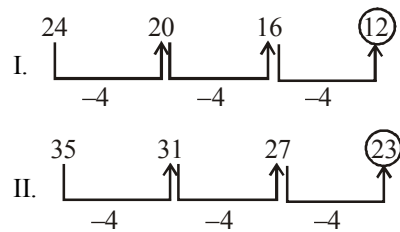

48. (d)

	F	I	F	T	Y	C	A	R	T	A	R
	↓	↓	↓	↓	↓	↓	↓	↓	↓	↓	↓
Coded as →	C	A	C	T	Y	P	O	L	T	O	L
				T	A	R	I	F	F		
				↓	↓	↓	↓	↓	↓		
				T	O	L	A	C	C		

49. (c) rtxy/ sxyz/ rtxy/ sxyz.

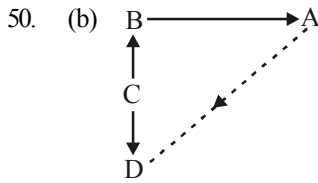

It is clearly shown that, D is in south west of A.

51. (a)
- 6 → 1 2 3 4 5
- 1 → 2 3 4 5 6
- 4 → 1 2 3 4 5 6

From above, it is clear that 3 is opposite to 4. Therefore, 1 is opposite 6.

52. (a) The father of the boy's uncle → the grandfather of the boy and daughter of the grandfather → sister of father.

53. (d)

Regions	1	2	4	6	7	8	9	10
Persons ↓								
Boys □	✓	✓	×	×	×	×	✓	×
Girls △	×	×	✓	×	×	✓	×	×
Sober ○	×	✓	✓	✓	✓	×	×	×
Cricketer ▭	✓	✓	×	✓	×	×	×	✓

Region 2 presents the boys who are cricketer and sober.

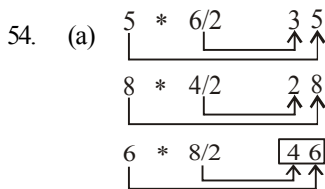

55. (b)
- $1 \times 2 \times 3 = 6$
- $2 \times 3 \times 4 = 24$
- $3 \times 4 \times 5 = 60$
- $4 \times 5 \times 6 = 120$
- $5 \times 6 \times 7 = 210$
- $6 \times 7 \times 8 = 336$

56. (d)
- First Column
- $12 \times 3 + 4 = 40$
- Second Column
- $15 \times 4 + 6 = 66$
- Third Column
- $16 \times 5 + 4 = \boxed{84}$

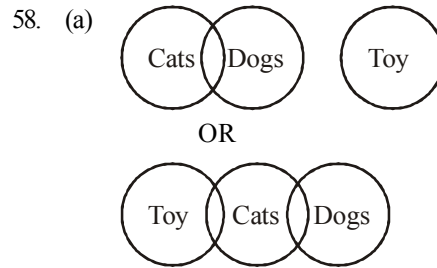
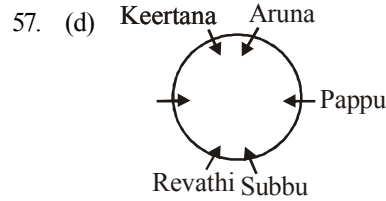

- Conclusion I : True
- II : Complementary Pair
- III : Complementary Pair
- IV : False

So, only conclusion I and either II or III.

59. (a) Suppose the present age of Arun is $4x$ years and that of Deepak is $3x$ years. 6 years hence,
- Arun's age = $4x + 6 = 26$
- $\Rightarrow 4x = 26 - 6 \quad x = \frac{20}{4} = 5$

- \therefore Present age of Deepak = $3x = 15$ years

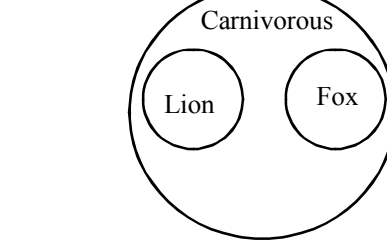

61. (b) AMZPEQIS
62. (b)
63. (b) There are 12 triangles in the given square.

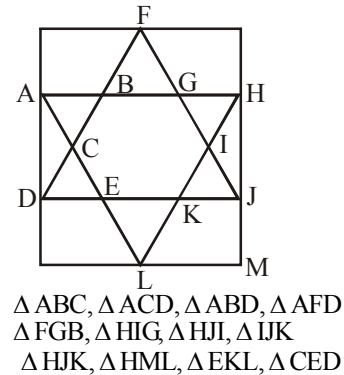

- assembly were elected by the Provincial assemblies by method of single transferable vote system of proportional representations. Members of the committee: Sardar Vallabhbhai Patel, K. M. Munshi, Acharya J.B kriplani . Lok Nayak Jai Prakash was not the member of the constituent assembly.
88. (c) Greenhouse gases catch the sun's radiation on its way back into space and reflect some of that warmth back to Earth, increasing temperatures. Carbon dioxide is known as greenhouse gas because of their ability to trap and reflect the sun's radiation back to Earth.
89. (b) A laser is a device that emits coherent light through a process called stimulated emission.
90. (c) Cowper's gland is related to reproductive system. Cowper's gland is the bulbourethral gland found in human males. They are found in pair and secrete viscous secretion called pre ejaculate that helps in coitus.
91. (a) Mist is a thin fog resulting from condensation in the air near to the earth's surface.
92. (a) Dyarchy was a system of double government introduced by British India.
93. (b) Mohammed Ali Jinnah was Indian Muslim politician, founder and first governor-general (1947-48) of Pakistan. As the first Governor-General of Pakistan, Jinnah worked to establish the new nation's government and policies, and to help settle the millions of Muslim migrants who had emigrated from the new nation of India to Pakistan after the partition. He is revered in Pakistan as Quaid-i-Azam.
94. (c) The Department of Economic Affairs (DEA) under Ministry of Finance is the nodal agency of the Union Government to formulate and monitor country's economic policies and programmes having a bearing on domestic and international aspects of economic management.
95. (c) Centrifugal force separates fat from milk.
96. (a) Total fixed costs are constant, so the average fixed cost curve diminishes with the output. Thus, the average fixed cost curve is a rectangular hyperbola.
97. (d) Malaria is a mosquito borne disease of humans and other animals caused by Plasmodium protozoan. Severe disease is largely caused by Plasmodium falciparum whereas mild forms are due to *P vivax*, *P oval* and *P malariae*.
98. (b) The focal length of a convex lens is shorter for blue light than for red.
99. (c) Ram Prasad Bismil was the famous freedom fighter who was involved in the historic Kakori train robbery. He was born in 1897 at Shahjahanpur, Uttar Pradesh. On 9th August, 1925, Ram Prasad Bismil along with his fellow followers looted the money of the British government from the train while it was passing through Kakori, Lucknow. Except Chandrashekhar Azad, all other members of the group were arrested. Ram Prasad Bismil along with others was given capital punishment. This great freedom fighter of India was executed on 19th December, 1927.
100. (c) Himadri Station is India's first Arctic research station located at Spitsbergen, Svalbard, Norway. It was inaugurated on the 1st of July, 2008 by the Minister of Earth Sciences.
101. (b) 102. (a) 103. (a) 104. (c) 105. (a)
 106. (a) 107. (d) 108. (d) 109. (c) 110. (d)
 111. (b) 112. (a) 113. (c) 114. (b) 115. (c)
 116. (d) 117. (c) 118. (c) 119. (b)
 120. (b) Indian Railways is set to launch "Tri-Netra (Terrain Imaging for diesel drivers infrared, enhanced optical and radar assisted system)" to check collisions between tracks.

ARITHMETIC

1. $\frac{1}{\sqrt{9}-\sqrt{8}} - \frac{1}{\sqrt{8}-\sqrt{7}} + \frac{1}{\sqrt{7}-\sqrt{6}} - \frac{1}{\sqrt{6}-\sqrt{5}}$
 $\frac{1}{\sqrt{5}-\sqrt{4}}$ equal to
 (a) 0 (b) 1 (c) 5 (d) $\frac{1}{3}$
2. What is the sum of the digits of the least number which when divided by 52, leaves 33 as remainder, when divided by 78 leaves 59 and when divided by 117, leaves 98 as remainder?
 (a) 17 (b) 18 (c) 19 (d) 21
3. If 1 is subtracted from the numerator of a fraction it becomes $(1/3)$ and if 5 is added to the denominator the fraction becomes $(1/4)$. Which fraction shall result, if 1 is subtracted from the numerator and 5 is added to the denominator?
 (a) $\frac{5}{12}$ (b) $\frac{7}{23}$ (c) $\frac{1}{8}$ (d) $\frac{2}{3}$
4. 38L of milk was poured into a tub and the tub was found to be 5% empty. To completely fill the tub, what amount of additional milk must be poured?
 (a) 1L (b) 2L (c) 3L (d) 4L
5. Prakash, Sunil and Anil started a business jointly investing ₹11 lakhs, ₹16.5 lakhs and ₹8.25 lakhs respectively. The profit earned by them in the business at the end of three years was ₹ 19.5 lakhs. What will be the 50% of Anil's share in the profit?
 (a) ₹4.5 lakhs (b) ₹2.25 lakhs
 (c) ₹2.5 lakhs (d) ₹3.75 lakhs
6. A ball is dropped from a height 64 m above the ground and every time it hits the ground it rises to a height equal to half of the previous. What is the height attained after it hits the ground for the 16th time?
 (a) 2^{-12} m (b) 2^{-11} m
 (c) 2^{-10} m (d) 2^{-9} m
7. If ₹ 8400 is divided among A, B and C in the ratio $\frac{1}{5} : \frac{1}{6} : \frac{1}{10}$, what is the share of A?
 (a) ₹ 3200 (b) ₹ 3400
 (c) ₹ 3600 (d) ₹ 3800
8. There are 45 male and 15 female employees in an office. If the mean salary of the 60 employees is ₹ 4800 and the mean salary of the male employees is ₹ 5000, then the mean salary of the female employees is
 (a) ₹ 4200 (b) ₹ 4500
 (c) ₹ 5600 (d) ₹ 6000
9. A train started from a station with a certain number of passengers. At the first halt, $\frac{1}{3}$ rd of its passengers got down and 120 passengers got in. At the second halt, half of the passengers got down and 100 persons got in. Then, the train left for its destination with 240 passengers. How many passengers were there in the train when it started?
 (a) 540 (b) 480 (c) 360 (d) 240
10. An equilateral triangle and a regular hexagon are inscribed in a given circle. If a and b are the lengths of their sides respectively, then which one of the following is correct.
 (a) $a^2 = 2b^2$ (b) $b^2 = 3a^3$
 (c) $b^2 = 2a^2$ (d) $a^2 = 3b^2$
11. The sides of a parallelogram are 12 cm and 8 cm long and one of the diagonals is 10 cm long. If d is the length of other diagonal, then which one of the following is correct?
 (a) $d < 8$ cm (b) $8 \text{ cm} < d < 10$ cm
 (c) $10 \text{ cm} < d < 12$ cm (d) $d > 12$ cm
12. ABC is an equilateral triangle inscribed in a circle. D is any point on the arc BC . What is $\angle ADB$ equal to?
 (a) 90° (b) 60°
 (c) 45° (d) None of the above

13. Which one of the following relations for the numbers 10, 7, 8, 5, 6, 8, 5, 8 and 6 is correct?
 (a) Mean = Median (b) Mean = Mode
 (c) Mean > Median (d) Mean > Mode
14. A round balloon of unit radius subtends an angle of 90° at the eye of an observer standing at a point, say A. What is the distance of the centre of the balloon from the point A?
 (a) $1/\sqrt{2}$ (b) $\sqrt{2}$
 (c) 2 (d) $1/2$
15. What is one of the value of x in the equation

$$\sqrt{\frac{x}{1-x}} + \sqrt{\frac{1-x}{x}} = \frac{13}{6}?$$

- (a) $\frac{5}{13}$ (b) $\frac{7}{13}$ (c) $\frac{9}{13}$ (d) $\frac{11}{3}$
16. If $pqr = 1$, what is the value of the expression
 $\frac{1}{1+p+q^{-1}} + \frac{1}{1+q+r^{-1}} + \frac{1}{1+r+p^{-1}}?$
 (a) 1 (b) -1
 (c) 0 (d) $1/3$
17. What should be subtracted from $27x^3 - 9x^2 - 6x - 5$ to make it exactly divisible by $(3x - 1)$?
 (a) -5 (b) -7
 (c) 5 (d) 7
18. If $1 + \tan \theta = \sqrt{2}$, then what is the value of $\cot \theta - 1$?
 (a) $\frac{1}{\sqrt{2}}$ (b) $\sqrt{2}$ (c) 2 (d) $\frac{1}{2}$

19. If $x + \left(\frac{1}{x}\right) = 2 \cos \alpha$, then what is the value of $x^2 + \left(\frac{1}{x^2}\right)?$
 (a) $4 \cos^2 a$
 (b) $4 \cos^2 a - 1$
 (c) $2 \cos^2 a - 2 \sin^2 a$
 (d) $\cos^2 a - \sin^2 a$
20. The angle of elevation of the top of an unfinished pillar at a point 150 m from its base is 30° . If the angle of elevation at the same point is to be 45° , then the pillar has to be raised to a height of how many metres?
 (a) 59.4 m (b) 61.4 m
 (c) 62.4 m (d) 63.4 m

DIRECTIONS (Q. 21-22): Study the following table carefully in answer the questions that follow :

Number of Executives recruited by Six different organisations over the years

Organisation	P	Q	R	S	T	U
2004	458	512	418	502	476	492
2005	522	536	472	500	482	523
2006	480	495	464	508	488	518
2007	506	505	428	444	490	534
2008	427	485	422	512	510	498
2009	492	488	444	499	512	510

21. What is the per cent increase in the number of Executives recruited by organisation R in 2005 from the previous year? (rounded off to two digits after decimal)
 (a) 18.67 (b) 12.92
 (c) 16.48 (d) 13.21
22. The number of Executives recruited by organisation T in the year 2008 forms approximately what percent of the total number of Executives recruited by all the organisations together in that year?
 (a) 11 (b) 31 (c) 18 (d) 26
23. If the area of a circle, inscribed in an equilateral triangle is $4\pi \text{ cm}^2$, then what is the area of the triangle?
 (a) $12\sqrt{3} \text{ cm}^2$ (b) $9\sqrt{3} \text{ cm}^2$
 (c) $8\sqrt{3} \text{ cm}^2$ (d) 18 cm^2
24. The HCF of $X^4 - 1$ and $X^4 - 2X^3 - 2X^2 - 2X - 3$ is
 (a) $(x^2+1)(x-1)$ (b) (x^2+1)
 (c) $(x^2+1)(x+1)$ (d) $(x+1)$
25. A cone is inscribed in a hemisphere such that their bases are common. If C is the volume of the cone and H that of the hemisphere, then what is the value of C : H?
 (a) 1 : 2 (b) 2 : 3
 (c) 3 : 4 (d) 4 : 5
26. If $x : y = 3 : 1$, then $x^3 - y^3 : x^3 + y^3 = ?$
 (a) 13 : 14 (b) 14 : 13
 (c) 10 : 11 (d) 11 : 10
27. $\sqrt{\sqrt{17956} + \sqrt{24025}} = ?$
 (a) 256 (b) 289
 (c) 155 (d) None of these

28. Three bells toll at intervals of 9, 12 and 15 minutes respectively. All the three begin to toll at 8 a.m. At what time will they toll together again?
 (a) 8.45 a.m. (b) 10.30 a.m.
 (c) 11.00 a.m. (d) 1.30 p.m.
29. The sum of five numbers is 924. The average of first two numbers is 201.5 and the average of last two number is 196. What is the third number?
 (a) 133
 (b) 129
 (c) 122
 (d) Cannot be determined
30. If the cost price is 96% of the selling price, then what is the profit percent?
 (a) 4.5% (b) 4.2%
 (c) 4% (d) 3.8%
31. If $A : B = 3 : 4$, $B : C = 8 : 10$ and $C : D = 15 : 17$. Then find $A : B : C : D$.
 (a) 9 : 12 : 13 : 11 (b) 4 : 5 : 6 : 7
 (c) 9 : 12 : 15 : 17 (d) None of these
32. X and Y can do job in 25 days and 30 days respectively. They work together for 5 days and then X leaves. Y will finish the rest of the work in how many days?
 (a) 18 days (b) 19 days
 (c) 20 days (d) 21 days
33. On a journey across Bombay, a tourist bus averages 10 km/h for 20% of the distance, 30 km/h for 60% of it and 20 km/h for the remainder. The average speed for the whole journey was
 (a) 10 km/h (b) 30 km/h
 (c) 5 km/h (d) 20 km/h
34. The area of a square field is 576 km². How long will it take for a horse to run around at the speed of 12 km/h?
 (a) 12 h (b) 10 h
 (c) 8 h (d) 6 h
35. A single discount equal to a discount series of 10% and 20% is
 (a) 25% (b) 28%
 (c) 30% (d) 35%
36. Three pipes A, B and C can fill a tank in 6 minutes, 8 minutes and 12 minutes, respectively. The pipe C is closed 6 minutes before the tank is filled. In what time will the tank be full?
 (a) 4 min (b) 6 min
 (c) 5 min (d) Data inadequate
37. A thief is noticed by a policeman from a distance of 200 m. The thief starts running and the policeman chases him. The thief and the policeman run at the rate of 10 km and 11 km per hour respectively. What is the distance between them after 6 minutes?
 (a) 100m (b) 150m
 (c) 190m (d) 200m
38. If $\frac{a}{b} = \frac{4}{5}$ and $\frac{b}{c} = \frac{15}{16}$, then $\frac{c^2 - a^2}{c^2 a^2}$ is
 (a) $\frac{1}{7}$ (b) $\frac{7}{25}$
 (c) $\frac{3}{4}$ (d) None of these
39. If $x + \frac{1}{x} = 2$ and x is real, then the value of $x^{17} + \frac{1}{x^{19}}$ is
 (a) 1 (b) 0 (c) 2 (d) -2
40. If $0 \leq \alpha \leq \frac{\pi}{2}$ and $2 \sin \alpha + 15 \cos^2 \alpha = 7$, then the value of $\sin \alpha$ is
 (a) $\frac{5}{4}$ (b) $\frac{4}{5}$ (c) $\frac{1}{4}$ (d) $\frac{1}{2}$

GENERAL INTELLIGENCE & REASONING

DIRECTIONS (Qs. 41-42) : In questions below, select the related word/letters/number from the given alternatives.

41. 9 : 24 :: ? : 6
 (a) 3 (b) 2
 (c) 1 (d) 5
42. STAR : SBUT :: WARD : ?
 (a) XBAW (b) ESBX
 (c) FAME (d) DRAW

DIRECTIONS (Qs. 43-44) : In questions find the odd word/letters//numbers pair from the given alternatives:

43. (a) (25, 49) (b) (121, 169)
 (c) (7, 169) (d) (9, 25)
44. (a) HEAT (b) MEAT
 (c) MEET (d) BEAT

DIRECTION : (Qs. 45-46) a series is given, with one term missing. Choose the correct alternative from the given ones that will complete the series.

45. BDFH, IKMO, PRTV, _
 (a) WYAC (b) WXYA
 (c) WXYZ (d) WYZA

46. 2, 65, 7, 59, 12, 53, __, __
 (a) 15, 42 (b) 17, 45
 (c) 17, 47 (d) 18, 48
47. How Many triangles are there in the given figure ?

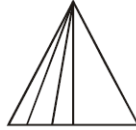

- (a) 5 (b) 12
 (c) 9 (d) 10
48. Arrange the words given below in a meaningful sequence.

1. Elephant 2. Cat
 3. Mosquito 4. Tiger
 5. Whale

- (a) 5, 3, 1, 2, 4 (b) 3, 2, 4, 1, 5
 (c) 1, 3, 5, 4, 2 (d) 2, 5, 1, 4, 3
49. If GOODNESS is coded as HNPCODTR, how can GREATNESS be written in that code?
 (a) HQFZSMFRT (b) HQFZUFRTM
 (c) HQFZUODTR (d) HQFZUMFRT

50. From the given alternatives select the word which cannot be formed using the letters of the given word.

LEGALIZATION

- (a) ALERT (b) ALEGATION
 (c) GALLANT (d) NATAL

51. Which one set of letters when sequentially placed at the gaps in the given letter series shall complete it?

B _ CCABB _ CABBC _ AB _ CCA

- (a) BCBC (b) BCCB
 (c) BBCC (d) BBBC

52. Seema walks 30 m North. Then she turns right and walks 30 m then she turns right and walks 55 m. Then she turns left and walks 20 m. Then she again turns left and walks 25m. How many metres away is she from her Original position?

- (a) 45 m (b) 50 m
 (c) 66 m (d) 55 m

53. A family consisted of a man, his wife, his three sons, their wives and three children in each son's family. How many members are there in the family?

- (a) 12 (b) 13
 (c) 15 (d) 17

54. If the 5th date of a month is Tuesday, what date will be 3 days after the 3rd Friday in the month?

- (a) 17 (b) 22
 (c) 19 (d) 18

55. Which of the following states the relationship between Manager, Labour Union and Worker?

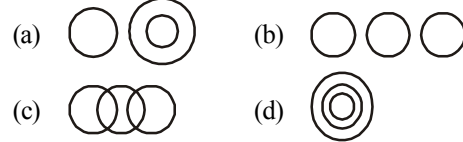

56. 12 year old Rahul is three times as old as his brother Raras. How old will Rahul be when he is twice as old as Paras?

- (a) 14 years (b) 20 years
 (c) 16 years (d) 18 years

DIRECTIONS (57-58) : In each of the following questions, select the missing number from the given responses.

57.

5	4	7	8
6	9	5	?
3	7	2	6

- (a) 6 (b) 4 (c) 10 (d) 8

- 58.

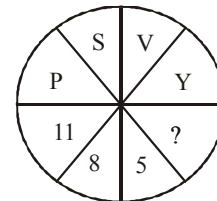

- (a) 6 (b) 7 (c) 3 (d) 2

DIRECTIONS (Qs. 59) : In question below, some statements are given followed by three conclusions respectively. You have to consider the statements to be true even if they seem to be at variance from commonly known facts. You have to decide which of the given conclusions if any, follow from the given statements.

59. **Statement :** Pictures can tell a story. All story books have pictures. Some story books have words.

Conclusions: I. Pictures can tell a story better than words can.

II. The stories in story books are very simple.

III. Some story books have both words and pictures.

- (a) Only conclusion I follows
 (b) Only conclusion II follows
 (c) Only conclusion III follows
 (d) Both conclusions I and II follow

60. There are five houses P, Q, R, S and T. P is right of Q and T is left of R and right of P. Q is right of S. Which house is in the middle ?

- (a) P (b) Q (c) T (d) R

DIRECTION (Qs. 61) : In question below, which answer figure will complete the pattern in the question figure ?

61. Question figure :

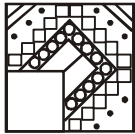

Answer figures :

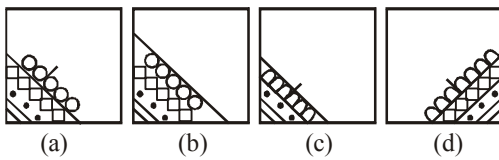

62. A Circular sheet of paper is folded in particular manner, punched once and then unfolded. Find Out the manner in which the paper was folded and punched from amongst the answer figures.

Question figure :

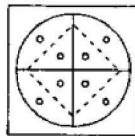

Answer figure:

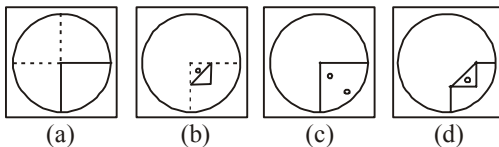

63. Select a suitable figure from the four alternatives that would complete the figure matrix.

Question figure:

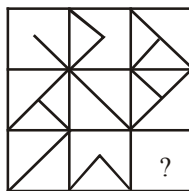

Answer figures:

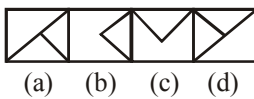

64. Which is the correct image if the picture is held in front of a mirror?

Question figure:

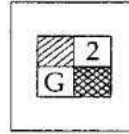

Answer figures:

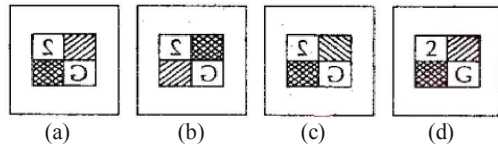

DIRECTIONS (Qs. 65) : A word is represented by only one set of numbers as given in any one of the alternatives. The sets of numbers given in the alternatives are represented by two classes of alphabets as in two matrices given below. The columns and rows of Matrix I are numbered from 0 to 4 and that of Matrix II are numbered from 5 to 9. A letter from these matrices can be represented first by its row and next by its column e.g., 'E' can be represented by 01, 13 etc., and 'L' can be represented by 56, 77 etc. Similarly, you have to identify the set for the word given in each question.

65. Matrix I

	0	1	2	3	4
0	A	E	M	N	P
1	N	P	A	E	M
2	E	M	N	P	A
3	P	A	E	M	N
4	M	N	P	A	E

Matrix II

	5	6	7	8	9
5	I	L	R	S	T
6	R	S	T	I	L
7	T	I	L	R	S
8	L	R	S	T	I
9	S	T	I	L	R

A I R S

- (a) 12, 76, 99, 78 (b) 43, 55, 86, 95
 (c) 00, 68, 78, 88 (d) 24, 69, 56, 78

66. B is the father of Q. B has only two children. Q is the brother of R. R is the daughter of P. A is the granddaughter of P and S is the father of A. How is S related to Q?
 (a) Son (b) Son-in-law
 (c) Brother (d) Brother-in-law
67. Unscramble the letters in the given words and find the odd one out.
 (a) UMRSME (b) EIWNTR
 (c) PIGRSN (d) LCUOD
68. If the first and second letters in the word DEPRESSION were interchanged, also the third and the fourth letters, the fifth and the sixth letters and so on, which of the following would be the seventh letter from the right ?
 (a) R (b) O (c) S (d) P
69. In P, Q, R, S, T and U, R is taller than only P and U. S is shorter than only T and Q. If each has different heights. then who will be at the third place when they are standing in descending order of their height and the counting is done in the same order (tallest to shortest)?
 (a) R (b) P (c) S (d) Q

DIRECTIONS (Qs. 70-71) : Read the following information carefully to answer the given questions.

V, U and T are sitting around a circle. A, B and C are also sitting around the same circle but two of them are not facing centre (they are facing the direction opposite to centre). Y is second to the left of C. U is second to the right of A. B is third to the left of T. C is second to the right of T. A is seated next to V.

70. Which of the following are not facing centre?
 (a) BA (b) CA
 (c) BC (d) Cannot be determined
71. Which of the following is the position of T in respect of B?
 (a) Third to the right
 (b) Second to the right
 (c) Third to the left
 (d) Third to the left or right

DIRECTIONS (Qs. 72-74): Answer these questions referring to the letter sequence given below:

NOPQYBZARSHIJKILMTUVGEFWXDC

72. If letters of the above given series are written in reverse order then which letter will be third to the left of eighteenth letter from your right?
 (a) Z (b) G
 (c) I (d) L
73. What will come in place of question mark (?) in the following series ?
 NDP, QWB, ZER, ?
 (a) SVJ (b) AFS
 (c) IVS (d) None of these
74. Which of the following is the fifth to the right of thirteenth letter from you left ?
 (a) T (b) J
 (c) S (d) Z
75. How many meaningful three letter English words can be formed with the letters AER, using each letter only once in each word ?
 (a) None (b) One
 (c) Three (d) Two
76. Each vowel of the word ADJECTIVE is substituted with the next letter of the English alphabetical series, and each consonant is substituted with the letter preceding it. How many vowels are present in the new arrangement ?
 (a) Four (b) One
 (c) Two (d) Three
77. In a certain code 'na pa ka so' means 'birds fly very high', 'ri so la pa' means 'birds are very beautiful' and 'ti me ka bo' means 'the parrots could fly'. Which of the following is the code for 'high' in that language ?
 (a) na (b) ka
 (c) bo (d) so
78. If the digits in the number 86435192 are arranged in ascending order, what will be the difference between the digits which are second from the right and fourth from the left in the new arrangement ?
 (a) One (b) Two
 (c) Three (d) Four
79. If it is possible to make only one meaningful word with the Third, Seventh, Eighth and Tenth letters of the word COMPATIBILITY, which of the following would be the last letter of that word ? If no such word can be made, give 'X' as your answer and if more than one such word can be formed, give your answer as 'Y'.
 (a) I (b) B
 (c) L (d) X
80. In a certain code FINE is written HGPC. How is SLIT written in that code ?
 (a) UTGR (b) UTKR
 (c) TUGR (d) None of these

GENERAL AWARENESS

81. When had Muslim league passed the resolution "Divide and Quit" movement ?
 (a) 1945 (b) 1943
 (c) 1944 (d) None of these
82. What is the ratio of money held by the public in currency to that they held in deposit ?
 (a) The currency deposit ratio
 (b) The reserve deposit ratio
 (c) Cash reserve ratio
 (d) Cash deposit ratio
83. The chemical behavior of an atom depends upon –
 (a) the number of Neutrons in the nucleus
 (b) the number of Nucleons in the nucleus
 (c) the number of Protons in its nucleus
 (d) the number of Electrons orbiting around the nucleus
84. 88th amendement of the Indian Constitution is related to –
 (a) The demarcation of new boundaries between states
 (b) The Constitution of the National Judicial Commission
 (c) Empowering the Centre to levy and appropriate Service tax
 (d) Readjustment of electoral constituencies on the basis of the population census 2001
85. The joint sitting of both Houses of Indian Parliament is held in connection with –
 (a) Constitutional amendment bill
 (b) Ordinary bill
 (c) Money bill
 (d) Election of the Vice – President of India
86. Many Fungi belonging to the genera Microporum Trichophyton and Epidermophyton are responsible for –
 (a) Filarial (b) Cancer /
 (c) Ringworms (d) AIDS
87. A boat will submerge when it displaces water equal to its own –
 (a) volume (b) weight
 (c) surface area (d) density
88. Which organ of Human body is affected by Alzheimer disease ?
 (a) Brain (b) Bone Marrow
 (c) Lung (d) Intestine
89. What is the chemical name of vitamin E ?
 (a) Calciferol (b) Tocopherol
 (c) Riboflavin (d) Phylloquinone
90. According to the Constitution of India, the Right to Property is a –
 (a) Fundamental Right
 (b) Directive Principle
 (c) Legal Right
 (d) Social Right
91. Babar declared himself as an emperor first at –
 (a) Samarqand (b) Farghana
 (c) Kabul (d) Panipat
92. How many times has financial emergency been declared in India, so far?
 (a) Five times (b) Four times
 (c) Once (d) Never
93. Economy is in the "Liquidity Trap" when –
 (a) Rate of interest on bonds is minimum
 (b) Rate of interest on bonds is maximum
 (c) Transaction demand for money is maximum
 (d) None of the above
94. Who is the author of "The Unseen Indira Gandhi" ?
 (a) K.P. Mathur
 (b) Bilal Siddique
 (c) Anurag Mathur
 (d) N.R. Narayana Murthy
95. What is 'biomagnification' ?
 (a) blowing up of environmental issues by man
 (b) growth of organisms due to food consumption
 (c) reduction of dissolved O₂ caused by microbial organisms
 (d) increase in the concentration of nondegradable pollutants as they pass through food chain
96. Subhash Chandra Bose formed the government for independent India in Singapore, on –
 (a) 22nd September, 1943
 (b) 20th October, 1943
 (c) 21st October, 1943
 (d) 22nd October, 1943
97. 'Laffer Curve' shows the relationship between –
 (a) Government Revenue and Government Expenditure.
 (b) Tax Rates and Tax Revenue.
 (c) Direct Taxes and GDP.
 (d) None of the above
98. 'Cerebral palsy' is a brain disorder found generally in –
 (a) Old people (b) Drug addicts
 (c) Small children (d) Only in ladies
99. India is not a member of which of the following constituent organizations of the World Bank Group?

- (a) International Centre for Settlement of Investment Disputes (ICSID)
 (b) International Development Association (IDA)
 (c) International Finance Corporation (IFC)
 (d) Multilateral Investment Guarantee Agency (MIGA)
- 100.** The mirror used in search light is –
 (a) Concave Mirror (b) Convex Mirror
 (c) Plane Mirror (d) None of these
- 101.** A.T.F. is related to –
 (a) Civil Aviation (b) Railways
 (c) Road transport (d) None of these
- 102.** A hybrid computer is the one having the combined properties of
 (a) Super and micro computers
 (b) Mini and micro computers
 (c) Analog and digital computers
 (d) Super and mini computers
- 103.** Which of the following statements are NOT correct?
 (a) Prithvi-II is a Surface-to-Surface Missile
 (b) Prithvi-II can carry a 500 kg nuclear warhead
 (c) Prithvi-II has a range of 350 KM
 (d) Akash is the naval variant of the Prithvi missile
- 104.** The 2016 Copa America Football tournament has been won by which of the following countries ?
 (a) Argentina (b) Colombia
 (c) Chile (d) Peru
- 105.** Which historical site has been declared as the SARRC cultural capital for 2016-17?
 (a) Bamiyan (b) Maynamati
 (c) Shilaidah (d) Mahashangarh
- 106.** What is called as the main folder on a storage device?
 (a) Platform (b) Interface
 (c) Root Directory (d) Home Page
- 107.** RAM is and
 (a) volatile, temporary
 (b) nonvolatile, permanent
 (c) nonvolatile, temporary
 (d) volatile, permanent
- 108.** Which is not an item of hardware?
 (a) An MP3 file (b) A keyboard
 (c) A monitor (d) A mouse
- 109.** The box that contains the central electronic components of the computer is the
 (a) motherboard (b) system unit
 (c) peripheral (d) input device
- 110.** Which type of device is computer monitor?
 (a) Input (b) Output
 (c) Processing (d) Software
- 111.** What is the rank of India in the world in terms of length of railroad network?
 (a) First (b) Second
 (c) Third (d) Fourth
- 112.** Which of the following ran the first train from Bori Bunder to Thane in 1853?
 (a) Bombay Baroda Railway
 (b) The Scindia Railway
 (c) Central India Railway
 (d) Great Indian Peninsula Railway
- 113.** The Maitree Express connects India with which of the following countries?
 (a) Myanmar (b) Pakistan
 (c) Bangladesh (d) Nepal
- 114.** Which of the following is the largest zone in terms of route kilometers?
 (a) Western Railways (b) Eastern Railways
 (c) Northern Railways (d) Southern Railways
- 115.** Which of the following is the largest marshalling yard in India (also the longest in Asia)?
 (a) Mughalsarai (b) Mathura
 (c) Itarasi (d) Guntakal
- 116.** Name the Chancellor of Nalanda University who has resigned from his post on 25 November 2016.
 (a) A.Goh Chok Tong (b) Vivian Balakrishna
 (c) George Yeo (d) Lee Hsien Loong
- 117.** The Cabinet Committee on Economic Affairs recently approved the setting up of Jawahar Navodaya Vidyalaya (JNV) in how many districts?
 (a) 34 (b) 48
 (c) 57 (d) 62
- 118.** Which of the following countries will chair the 2017 Energy Club of Shanghai Cooperation Organization?
 (a) Uzbekistan (b) Mongolia
 (c) Turkey (d) China
- 119.** Who will be the Chief Guest at the 14th Pravasi Bharatiya Divas (PBD) Convention which will be held in Bengaluru from January 7 to 9, 2017 ?
 (a) Mohammed bin Zayed Al Nahyan
 (b) Marcelo Rebelo de Sousa
 (c) Rodrigo Duterte
 (d) Antonio Costa
- 120.** Who is the author of the book "Gita Press and the Making of Hindu India" that won the Bhatt First Book Prize 2016?
 (a) Manu S. Pillai (b) Akshaya Mukul
 (c) Madhu Gurung (d) Sophia Khan

Hints & Explanations

$$1. \quad (c) \quad \frac{1}{\sqrt{9}-\sqrt{8}} - \frac{1}{\sqrt{8}-\sqrt{7}} + \frac{1}{\sqrt{7}-\sqrt{6}}$$

$$- \frac{1}{\sqrt{6}-\sqrt{5}} + \frac{1}{\sqrt{5}-\sqrt{4}} \text{ (on rationalisation)}$$

$$= (\sqrt{9} + \sqrt{8}) - (\sqrt{8} + \sqrt{7}) + (\sqrt{7} + \sqrt{6})$$

$$- (\sqrt{6} + \sqrt{5}) + (\sqrt{5} + \sqrt{4})$$

$$= \sqrt{9} + \sqrt{4} = 3 + 2 = 5$$

$$2. \quad (a) \quad \text{Here, } 52 - 33 = 78 - 59 = 117 - 98 = 19$$

$$\text{Now, } 52 = 13 \times 2 \times 2$$

$$78 = 13 \times 2 \times 3$$

$$117 = 13 \times 3 \times 3$$

$$\therefore \text{ LCM} = 13 \times 2 \times 2 \times 3 \times 3 = 468$$

$$\therefore \text{ Required number} = 468 - 19 = 449$$

Hence, the sum of digits is 17.

$$3. \quad (c) \quad \text{Let the numerator and denominator of a fraction are } x \text{ and } y, \text{ respectively,}$$

According to question,

$$\frac{x-1}{y} = \frac{1}{3} \Rightarrow 3x - 3 = y \Rightarrow 3x - y = 3 \dots (i)$$

$$\text{and } \frac{x}{y+5} = \frac{1}{4} \Rightarrow 4x - y = 5 \dots (ii)$$

On solving eqs. (i) and (ii), we get

$$x = 2 \text{ and } y = 3$$

\therefore Required fraction

$$= \frac{x-1}{y+5} = \frac{2-1}{3+5} = \frac{1}{8}$$

$$4. \quad (b) \quad \text{Let tub capacity } x \text{ L.}$$

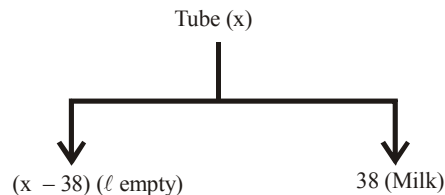

$$\text{Now, } x \times \frac{95}{100} = 38$$

$$x = 40 \text{ L,}$$

$$\text{Additional milk} = 40 \text{ L} - 38 \text{ L} = 2 \text{ L.}$$

$$5. \quad (b) \quad \text{Profit will be shared in the ratio of}$$

$$11 \times 3 : 16.5 \times 3 : 8.25 \times 3$$

$$= 11 : 16.5 : 8.25 = 44 : 66 : 33$$

Anil's share in the profit

$$= \frac{33}{143} \times 19.5 = 14.5 \text{ lakh}$$

$$50\% \text{ of Anil's share} = 2.25 \text{ lakh}$$

$$6. \quad (c) \quad \text{After 1st hit ball height will be } = \frac{1}{2} (64)$$

After 2nd hit ball height will be =

$$\left(\frac{1}{2}\right)^2 (64)$$

.....

.....

.....

After 16th hit ball height will be

$$= \left(\frac{1}{2}\right)^{16} (64) = \frac{1}{2^{16}} (2^6) = 2^{-10} \text{ m}$$

$$7. \quad (c) \quad \text{Given, } A : B : C = \frac{1}{5} : \frac{1}{6} : \frac{1}{10} = 6 : 5 : 3$$

\therefore Share of A

$$= \frac{6}{6+5+3} \times 8400 = \frac{6}{14} \times 8400 = ₹ 3600$$

$$8. \quad (a) \quad \text{Given that,}$$

Number of male employees (M) = 45

Number of female employees (F) = 15

Mean salary of male employee (\bar{x}_M)

= ₹ 5000

Total number of employees = (M + F)

$$= 45 + 15 = 60$$

Mean salary of employees (\bar{x}_{MF}) = ₹ 4800

Let mean salary of female employee is \bar{x}_F

By formula,

$$\bar{x}_{MF} = \frac{M \bar{x}_M + F \bar{x}_F}{(M + F)}$$

$$\Rightarrow 4800 = \frac{45 \times 5000 + 15 \times \bar{x}_F}{60}$$

$$\Rightarrow 4800 \times 60 - 45 \times 5000 = 15 \times \bar{x}_F$$

$$\therefore \bar{x}_F = 4800 \times 4 - 3 \times 5000$$

$$= 300(16 \times 4 - 50) = 300 \times 14 = 4200.$$

9. (d) Suppose number of passengers be x in the starting.

Number of passengers after 1st halt

$$= \left(x - \frac{x}{3}\right) + 120 = \frac{2x}{3} + 120$$

Number of passengers after 2nd halt

$$= \frac{1}{2} \left(\frac{2x}{3} + 120\right) + 100$$

According to question,

Number of passengers after 2nd halt

$$= \frac{1}{2} \left(\frac{2x}{3} + 120\right) + 100 = 240$$

$$\Rightarrow \frac{2x}{3} + 120 = (240 - 100) \times 2$$

$$\Rightarrow \frac{2x}{3} = 280 - 120$$

$$\frac{2x}{3} = 160$$

$$x = \frac{160 \times 3}{2}$$

$$x = 240$$

10. (d) We know altitude of equilateral $\triangle ABC$ is

$$\frac{\sqrt{3}}{2} a.$$

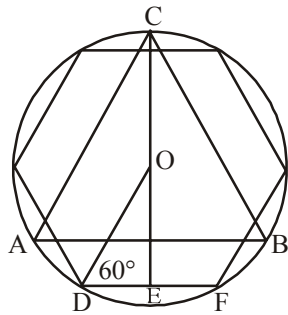

$$\therefore \text{Length of } OC = \frac{\sqrt{3}}{2} a \times \frac{2}{3} = \frac{a}{\sqrt{3}} = \text{radius}$$

$$\text{Also, } DF = b \Rightarrow DE = \frac{b}{2}$$

$$\text{In } \triangle ODE, \cos 60^\circ = \frac{DE}{OD} = \frac{b/2}{a/\sqrt{3}}$$

$$\Rightarrow \frac{1}{2} = \frac{\sqrt{3}b}{2a} \Rightarrow a = \sqrt{3}b$$

$$\therefore a^2 = 3b^2$$

11. (d) In parallelogram, $d^2 + d_2^2 = 2(l^2 + b^2)$

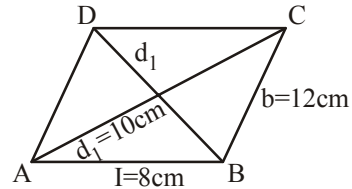

$$\therefore d^2 + (10)^2 = 2(64 + 144)$$

$$\Rightarrow d^2 = 2 \times 208 - 100$$

$$\Rightarrow d^2 = 416 - 100 = 316$$

$$\Rightarrow d = \sqrt{316}$$

$$\Rightarrow d = 17.76 \text{ cm}$$

$$d > 12$$

12. (b)

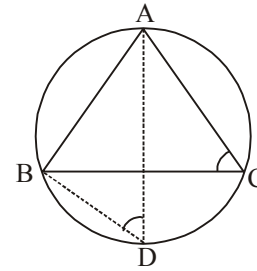

$$\angle ADB = \angle ACB = 60^\circ$$

(angles in the same segment are equal)

13. (a) Given numbers are 10, 7, 8, 5, 6, 8, 5, 8 and 6

Arrange in ascending order

$$5, 5, 6, 6, 7, 8, 8, 8, 10$$

Total term, $n = 9$ (odd)

Now,

$$(i) \text{ Mean} = \frac{5 + 5 + 6 + 6 + 7 + 8 + 8 + 8 + 10}{9}$$

$$= \frac{63}{9} = 7$$

$$(ii) \text{ Median} = \left(\frac{n+1}{2}\right)\text{th term}$$

$$= \left(\frac{9+1}{2}\right)\text{th term}$$

$$= 5\text{th term} = 7$$

(iii) Mode = 8 because of higher frequency term

$$\therefore \text{Mean} = \text{Median}$$

14. (b) Let O = Centre of the balloon
OB = OC = Radii of the balloon

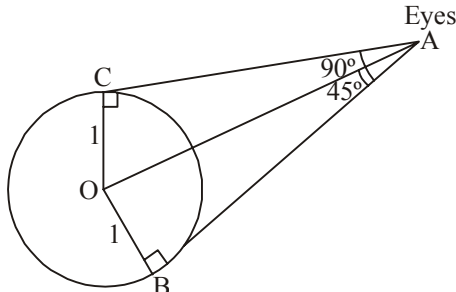

In $\triangle OBA$, $\sin 45^\circ$
 $= \frac{OB}{OA} \Rightarrow \frac{1}{\sqrt{2}} = \frac{1}{OA} \Rightarrow OA = \sqrt{2}$

15. (c) Let $\sqrt{\frac{x}{1-x}} = y$

$\therefore y + \frac{1}{y} = \frac{13}{6} \Rightarrow (y^2 + 1)6 = 13y$
 $\Rightarrow 6y^2 - 13y + 6 = 0 \Rightarrow 6y^2 - 9y - 4y + 6 = 0$
 $\Rightarrow 3y(2y - 3) - 2(2y - 3) = 0$
 $\Rightarrow (3y - 2)(2y - 3) = 0$
 $\therefore y = \frac{2}{3}$ and $\frac{3}{2}$

When, we put $y = \frac{2}{3} \Rightarrow \frac{x}{1-x} = \frac{4}{9}$

$\Rightarrow 9x = 4 - 4x \Rightarrow x = \frac{4}{13}$

When we put $y = \frac{3}{2}$

$\Rightarrow \frac{x}{1-x} = \frac{9}{4} \Rightarrow 4x = 9 - 9x$

$\therefore x = \frac{9}{13}$

16. (a) $\frac{1}{1+p+q^{-1}} + \frac{1}{1+q+r^{-1}} + \frac{1}{1+r+p^{-1}}$
 $= \frac{1}{1+p+\frac{1}{q}} + \frac{1}{1+q+\frac{1}{r}} + \frac{1}{1+r+\frac{1}{p}}$
 $= \frac{q}{1+pq+q} + \frac{r}{r+rq+1} + \frac{p}{p+rp+1}$
 $= \frac{q}{1+pq+q} + \frac{r}{\frac{1}{pq} + \frac{1}{p} + 1} + \frac{p}{p + \frac{1}{q} + 1}$
 $(\because pqr = 1)$

$= \frac{q}{1+pq+q} + \frac{rpq}{1+q+pq} + \frac{pq}{pq+1+q}$
 $= \frac{q+rpq+pq}{1+pq+q} \quad (\because pqr = 1)$
 $= \frac{q+1+pq}{1+pq+q} = 1$

17. (b)
$$\begin{array}{r} 9x^2 - 2 \\ 3x - 1 \overline{) 27x^3 - 9x^2 - 6x - 5} \\ \underline{27x^3 - 9x^2} \\ -6x - 5 \\ \underline{+ 6x + 2} \\ -7 \end{array}$$

18. (b) $1 + \tan \theta = \sqrt{2}$
 $\Rightarrow \tan \theta = \sqrt{2} - 1$
 $\therefore \cot \theta - 1 = \frac{1}{\sqrt{2} - 1} - 1 = \frac{\sqrt{2} + 1}{2 - 1} - 1 = \sqrt{2}$

19. (c) $x + \frac{1}{x} = 2 \cos \alpha$
 Squaring both sides, then we get
 $x^2 + \frac{1}{x^2} + 2 = 4 \cos^2 \alpha$
 $\Rightarrow x^2 + \frac{1}{x^2} = 2(2 \cos^2 \alpha - 1)$
 $= 2(2 \cos^2 \alpha - \sin^2 \alpha - \cos^2 \alpha)$
 $= 2 \cos^2 \alpha - 2 \sin^2 \alpha$

20. (d) Let BC = x m height of unfinished pillar
and CD = h m = Raised height of pillar

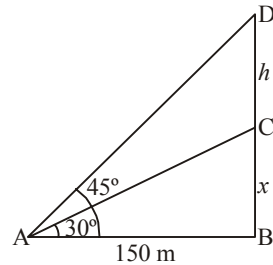

In $\triangle ABC$,
 $\tan 30^\circ = \frac{x}{150} \Rightarrow x = \frac{150}{\sqrt{3}}$

and in $\triangle ABD$,

$$\tan 45^\circ = \frac{h}{150} \Rightarrow 1 = \frac{h}{150}$$

$$\Rightarrow 150 = h + \frac{150}{\sqrt{3}} \quad [\text{from Eq. (i)}]$$

$$\Rightarrow \frac{150(\sqrt{3}-1)}{\sqrt{3}} = \Rightarrow$$

$$h = 150 \times \frac{(1.732-1)}{1.732}$$

$$= \frac{150 \times 0.732}{1.732} = 63.39 \approx 63.4 \text{ m}$$

21. (b) Required % increase

$$= \frac{54}{418} \times 100 = 12.919 \approx 12.92\%$$

22. (c) Required % = $\frac{510}{2854} \times 100 \approx 18\%$

23. (a) Since, area of circle = $4\pi \text{ cm}^2$ (given)
 $\Rightarrow \pi r^2 = 4\pi \Rightarrow r = 2 \text{ cm}$

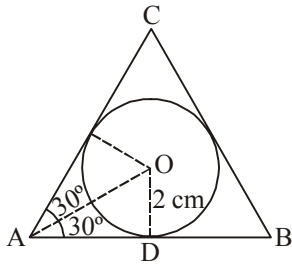

$$\text{In } \triangle OAD, \tan 30^\circ = \frac{OD}{AD} \Rightarrow AD = 2\sqrt{3} \text{ cm}$$

$$\text{Now, } AB = 2AD = 4\sqrt{3} \text{ cm}$$

\therefore Area of equilateral $\triangle ABC$

$$= \frac{\sqrt{3}}{4} (AB)^2 = \frac{\sqrt{3}}{4} (4\sqrt{3})^2$$

$$= 12\sqrt{3} \text{ cm}^2$$

24. (c) $x^4 - 1 = (x^2 - 1)(x^2 + 1) = (x - 1)(x + 1)(x^2 + 1)$
 $(x^2 + 1)$ Now $x^4 - 2x^3 - 2x^2 - 2x - 3$
 Putting $x = -1$ in this equation gives 0, so $(x + 1)$ is a factor, divide $x^4 - 2x^3 - 2x^2 - 2x - 3$ by $(x + 1)$ gives $x^3 - 3x^2 + x - 3$
 Now put $x = 3$, gives 0, so another factor is $(x - 3)$, divide $(x - 3)$ gives $x^2 + 1$ which cannot be further divided

So $x^4 - 2x^3 - 2x^2 - 2x - 3 = (x^2 + 1)(x + 1)(x - 3)$
 Now common factors in both expressions are $(x^2 + 1)(x + 1)$ which is the HCF.

25. (a) Volume of cone, $C = \frac{1}{3}\pi R^2 H$

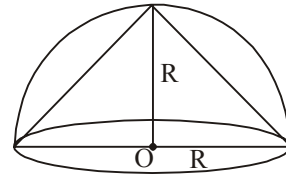

$$= \frac{1}{3}\pi R^3 \quad (\because H = R)$$

$$\text{Volume of hemisphere, } H = \frac{2}{3}\pi R^3$$

$$\therefore C : H = \frac{1}{3}\pi R^3 : \frac{2}{3}\pi R^3 \quad 1 : 2$$

26. (a) $\frac{x}{y} = \frac{3}{1} \Rightarrow \frac{x^3}{y^3} = \frac{27}{1} \Rightarrow \frac{x^3 - y^3}{x^3 - y^3} = \frac{27 - 1}{27 - 1}$

[By componendo and dividendo]

$$= \frac{26}{28} = \frac{13}{14}$$

27. (d) $\frac{\sqrt{17956}}{\sqrt{24025}} = ?$

$$\sqrt{17956} = \sqrt{2^2 \times 67^2} = 2 \times 67 = 134$$

$$\sqrt{24025} = \sqrt{5^2 \times 31^2} = 5 \times 31 = 155$$

$$\text{Hence, } ? = \frac{134}{155} = \frac{\sqrt{134 \times 17}}{\sqrt{289 \times 17}} = \frac{17}{17} = 1$$

28. (c) Bells will toll together again at a time, which is obtained by taking L.C.M. of their individual tolling intervals.

L.C.M. of 9, 12 and 15 = 180 min

They will toll together again after 180 min, i.e. 3 hours.

Time = 8 + 3 = 11 a.m.

29. (b) Third number
 $= 924 - (2 \times 2015 + 2 \times 196) = 924 - (403 + 392)$
 $= 924 - 795 = 129$

30. (b) Let S.P. = ₹ 100. Then, C.P. = ₹ 96; Profit = ₹ 4

\therefore Profit %

$$= \left(\frac{4}{96} \times 100 \right) \% = \frac{25}{6} \%$$

$$= 4.17\% \approx 4.2\%$$

31. (c) A : B = 3 : 4
B : C = 8 : 10
C : D = 15 : 17
A : B : C : D = $3 \times 8 \times 15 : 4 \times 8 \times 15 : 4 \times 10 \times 15 : 4 \times 10 \times 17$
= 9 : 12 : 15 : 17
32. (b) X's one day's work = $\frac{1}{25}$ th part of whole work.
Y's one day's work = $\frac{1}{30}$ th part of whole work.
Their one day's work = $\frac{1}{25} + \frac{1}{30} + \frac{1}{150}$ th part of whole work.
Now, work is done in 5 days
= $\frac{11}{150} \times 5 = \frac{11}{30}$ th of whole work
 \therefore Remaining work = $1 - \frac{11}{30} = \frac{19}{30}$ th of whole work
Now, $\frac{1}{30}$ th work is done by Y in one day.
 $\therefore \frac{19}{30}$ th work is done by Y in $\frac{1}{1/30} \times \frac{19}{30} = 19$ days
33. (d) Let the average speed be x km/h.
and Total distance = y km. Then,
 $\frac{0.2}{10}y + \frac{0.6}{30}y + \frac{0.2}{20}y = \frac{y}{x}$
 $\Rightarrow x = \frac{1}{0.05} = 20$ km/h
34. (c) Area of field = 576 km².
Then, each side of field = $\sqrt{576} = 24$ km
Distance covered by the horse
= Perimeter of square field
= $24 \times 4 = 96$ km
 \therefore Time taken by horse = $\frac{\text{distance}}{\text{speed}} = \frac{96}{12} = 8$ h
35. (b) Equivalent discount = $10 + 20 - \frac{10 \times 20}{100} = 30 - 2 = 28\%$
36. (a) Let it takes t minutes to completely fill the tank.
Now, $\frac{t}{6} + \frac{t}{8} + \frac{t-6}{12} = 1$
or $\frac{4t}{24} + \frac{3t}{24} + \frac{2t-12}{24} = 1$
or $9t - 12 = 24$
or $9t = 36 \Rightarrow t = 4$ min.
37. (a) Relative speed of the thief and policeman = $(11 - 10)$ km/h = 1 km/h.
Distance covered in 6 minutes
= $\left(\frac{1}{60} \times 6\right)$ km = $\frac{1}{10}$ km = 100 m.
 \therefore Distance between the thief and policeman = $(200 - 100)$ m = 100 m.
38. (b) $\frac{a}{b} = \frac{4}{5}$ and $\frac{b}{c} = \frac{15}{16} \Rightarrow \left(\frac{a}{b} \times \frac{b}{c}\right) = \left(\frac{4}{5} \times \frac{15}{16}\right) \Rightarrow \frac{a}{c} = \frac{3}{4}$
 $\therefore \frac{c^2 - a^2}{c^2} = \frac{1 - \left(\frac{a^2}{c^2}\right)}{1 - \left(\frac{a}{c}\right)^2} = \frac{1 - \frac{9}{16}}{1 - \frac{9}{16}} = \frac{7}{25}$
39. (c) $x + \frac{1}{x} = 2$
 $\Rightarrow x^2 - 2x + 1 = 0$
 $\Rightarrow (x-1)^2 = 0 \Rightarrow x = 1$
 $\therefore x^{17} + \frac{1}{x^{19}} = 1 + 1 = 2$
40. (b) $2 \sin \alpha + 15 \cos^2 \alpha = 7$
 $2 \sin \alpha + 15(1 - \sin^2 \alpha) = 7$
 $2 \sin \alpha + 15 - 15 \sin^2 \alpha = 7$
 $-15 \sin^2 \alpha + 2 \sin \alpha + 8 = 0$
 $(5 \sin \alpha - 4)(3 \sin \alpha + 2) = 0$
 $\sin \alpha = \frac{4}{5}$ or $-\frac{2}{3}$

41. (a) As, $9 \times 3 - 3 = 24$
 $3 \times 3 - 3 = 6$

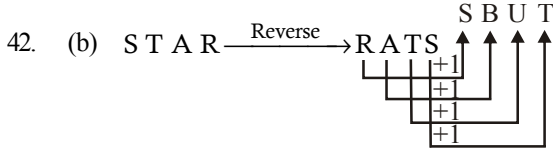

Similarly,

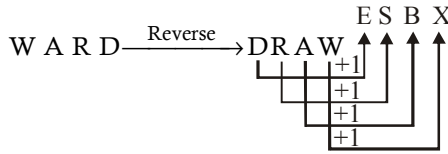

43. (c) Except in the number pair (7, 169) in all other number pairs both the numbers are perfect squares.

$(25, 49) \Rightarrow [(5)^2, (7)^2]$
 $(121, 169) \Rightarrow [(11)^2, (13)^2]$
 $(9, 25) \Rightarrow [(3)^2, (5)^2]$

44. (c) In the word MEET, the second and the third letters are the same.

45. (a)

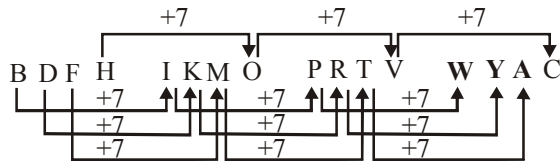

46. (c)

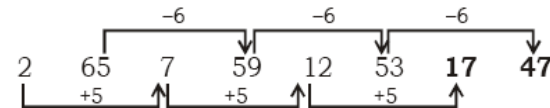

47. (d)

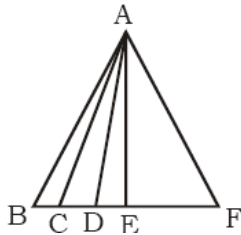

There are 10 triangles in the given figure – ABC, ABD, ABE, ABF, ACD, ACE, ACF, ADE, ADF, and AEF

48. (b) The correct order is:

3 2 4 1 5
 Mosquito \rightarrow Cat \rightarrow Tiger \rightarrow Elephant \rightarrow Whale

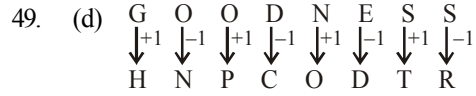

Similarly,

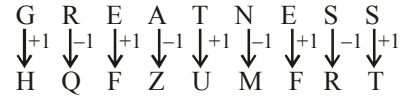

50. (a) ALERT can not be formed as there is no 'R' in the word LEGALIZATION. Hence, (a) is the correct choice.

51. (b) The sequence BBCCA is repeated
 B B C C A / B B C C A / B B C C A / B B C C A

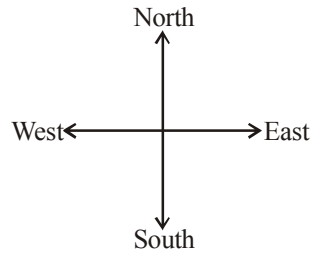
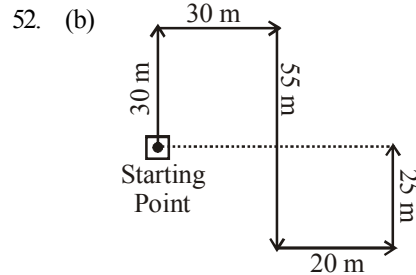

Required distance = $30\text{m} + 20\text{m} = 50\text{m}$

53. (d) A man + his wife = $1 + 1 = 2$
 His three sons + their wives = $3 + 3 = 6$
 Three children in each one's family = $3 \times 3 = 9$
 Total members = $2 + 6 + 9 = 17$

54. (d) 5th date of a month is Tuesday
 Friday will be on = $5 + 3$
 = 8th of a month
 1st Friday is on 1st of a month
 2nd Friday is on 8th of a month
 3rd Friday will be on 15th of a month
 3 days after 15th = $15 + 3 = 18$

55. (a)

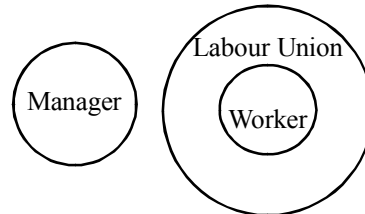

56. (c) Rahul's present age = 12 yrs,
Paras present age = 4 yrs
Let Rahul be twice as old as Paras after x yrs from now.
Then, $12 + x = 2(4 + x)$
 $= 12 + x = 8 + 2x \Rightarrow x = 4$
Hence, Rahul's required age = $12 + x \Rightarrow 16$ yrs
57. (c) As, $(5 + 4 + 7) / 2 = 8$
 $(3 + 7 + 2) / 2 = 6$
Similarly,
 $(6 + 9 + 5) / 2 = 10$.
58. (d) Putting the position of the letters in reverse order
 $P = 11, S = 8, V = 5$ and $Y = 2$.

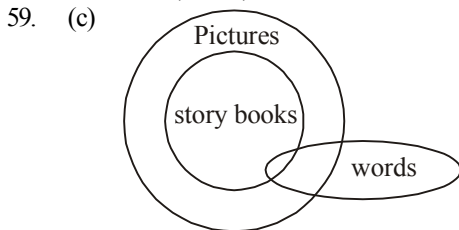

Conclusions : (a) False
(b) False
(c) True
(d) False

60. (a) $\begin{matrix} \uparrow & \uparrow & \uparrow & \uparrow & \uparrow \\ S & Q & P & T & R \end{matrix}$
61. (a) 62. (c)
63. (b) The third figure in each row comprises of parts which are not common to the first two figures.
64. (c)
(b) $\begin{matrix} A & I & R & S \\ \downarrow & \downarrow & \downarrow & \downarrow \end{matrix}$
66. (d) Let us draw the family diagram

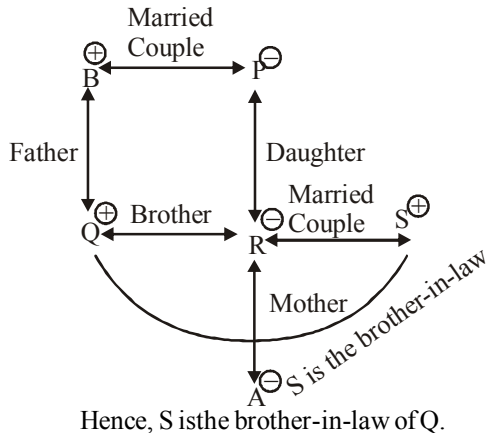

67. (d) (a) Summer (b) Winter (c) Spring (d) Cloud
All others are name of seasons.
68. (d) The new letter sequence is EDRPSEISNO.
The seventh letter from the right is P.
69. (c) According to the question, $R > P/U; T/Q > S$
 $\therefore T/Q > S > R > P/U$
 $\therefore 3^{\text{rd}}$ tallest = S

(Qs. 70-71):

Sitting Arrangement:

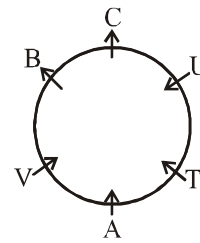

70. (c) B and C are not facing centre.
71. (d) The position of T in respect of B is third to the left or right.
72. (b) $18 + 3 = 21^{\text{st}}$ letter from the right in the reverse series or, 21^{st} letter from the left in the original series.
73. (d) $N + 3 = Q, Q + 3 = Z, Z + 3 = S$
 $D - 2 = W, W - 2 = E, E - 2 = V$
 $P + 3 = B, B + 3 = R, R + 3 = I$ Hence, $? = SVI$
74. (a) $13 + 5 = 18^{\text{th}}$ from you left
75. (c) Meaningful words : ARE, EAR, ERA
76. (c)

$\begin{matrix} A & D & J & E & C & T & I & V & E \\ +1 \downarrow -1 \downarrow -1 \downarrow +1 \downarrow -1 \downarrow -1 \downarrow +1 \downarrow - \downarrow + \downarrow \\ B & C & I & F & B & S & J & U & F \end{matrix}$

77. (a) na pa ka so \rightarrow birds fly very high
ri so la pa \rightarrow birds are very beautiful
ti me ka bo \rightarrow the parrots could fly
Thus high is coded as na.
78. (d) 1 2 3 4 5 6 7 8 9
Difference = $8 - 4 = 4$
79. (b) 1 2 3 4 5 6 7 8 9 10 11 12 13
C O M P A T I B I L I T Y
Meaningful word \Rightarrow LIM B

80. (d) $A \xrightarrow{2} F \xrightarrow{-2} H$
 $I \xrightarrow{-2} G$
 $N \xrightarrow{2} P$
 $E \xrightarrow{-2} C$
 Similarly,
 $S \xrightarrow{2} U$
 $L \xrightarrow{-2} J$
 $I \xrightarrow{2} K$
 $T \xrightarrow{-2} R$
81. (b) The communal question had become a baffling one as the Muslim League tightened its demand for Pakistan. Against the congress demand of “quit India”, the Muslim League’s new slogan was “Divide and quit”. On March 21, 1943, Muslim League observed as Pakistan Day.
82. (a) The currency deposit ratio shows the amount of currency that people hold as a proportion of aggregate deposits. An increase in cash deposit ratio leads to a decrease in money multiplier. An increase in deposit rates will induce depositors to deposit more, thereby leading to a decrease in cash to Aggregate Deposit ratio. This will in turn lead to a rise in Money Multiplier.
83. (d) The chemical behaviour of an atom depends upon the number of Electrons orbiting around the nucleus.
84. (c) 85. (b) 86. (c)
87. (b) A boat will float when the weight of the water displaced equals the weight of the boat and anything will float if it is shaped to displace its own weight of water before it reaches the point where it will submerge. Floating of the boat works on the principle of buoyancy force which is an upward force exerted by a liquid, gas or other fluid, that opposes the weight of an immersed object.
88. (a) Alzheimer’s disease affects the brain. The disease causes degeneration of brain tissues and nerve cells.
89. (b) Chemical name of Vitamin E is Tocopherols.
90. (c) The Indian Constitution does not recognize the property right as a fundamental right. In the year 1977, the 44th amendment eliminated the right to acquire, hold and dispose of property as a fundamental right. However, in another part of the Constitution, Article 300 (a) was inserted to affirm that no person shall be deprived of his property by the authority of law.
91. (d) Babur declared himself as the emperor at Panipat.
92. (d) Financial emergency in India has never been declared so far.
93. (a) A liquidity trap is a situation, described in the Keynesian Economics, in which injections of cash into the private banking system by a central bank fail to decrease interest rates and hence make monetary policy ineffective. A liquidity trap is caused when people hoard cash because they expect an adverse event such as deflation, insufficient aggregate demand, or war. Common characteristics of a liquidity trap are interest rates that are close to zero and fluctuations in the money supply that fail to translate into fluctuations in price levels.
94. (a) The book “The Unseen Indira Gandhi” has been authored by Dr. KP Mathur, who was the personal physician of the former Prime Minister Indira Gandhi for nearly 20 years till her assassination in 1984. The foreword of the book was written by her granddaughter Priyanka Gandhi Vadra. The book provides some interesting peeps into the responses of Mrs. Gandhi’s to challenges both personal and political.
95. (d) Biomagnification, also known as bioamplification or biological magnification, is the increasing concentration of a substance, such as a toxic chemical, in the tissues of organisms at successively higher levels in a food chain.
96. (c) On 21st October, 1943, Subhas Chandra Bose proclaimed the formation of the Provisional Government of Free India at the Cathay Cinema Hall. Two days later, he declared war on Britain and the United States. With help from the Japanese, he reorganised and rejuvenated the *Azad Hind Fauj* (also called the Indian National Army).

He lobbied aggressively for funds in Malaya and other parts of Southeast Asia and launched a recruitment drive for the *Azad Hind Fauj*.

97. (b) The Laffer curve, invented by Arthur Laffer, shows the relationship between tax rates and tax revenue collected by governments. The chart below shows the Laffer Curve:

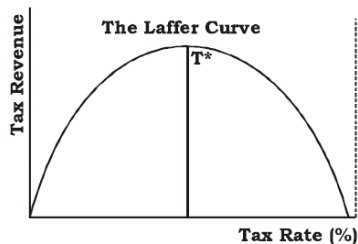

98. (c) Cerebral palsy (CP) is a group of permanent movement disorders that appear in early childhood. Signs and symptoms vary between people. Often, symptoms include poor coordination, stiff muscles, weak muscles, and tremors. There may be problems with sensation, vision, hearing, swallowing, and speaking. Often babies with cerebral palsy do not roll over, sit, crawl, or walk as early as other children their age. Difficulty with the ability to think or reason and seizures each occurs in about one third of people with CP.

99. (a) The World Bank Group consists of –
- International Bank for Reconstruction and Development (IBRD), established in 1945, which provides debt financing on the basis of sovereign guarantees;
 - International Finance Corporation (IFC), established in 1956, provides various forms of financing without sovereign guarantees, primarily to the private sector;
 - International Development Association (IDA), established in 1960, provides concessional financing (interest-free loans or grants), usually with sovereign guarantees;
 - International Centre for Settlement of Investment Disputes (ICSID), established in 1965, which works with governments to reduce investment risk;

- Multilateral Investment Guarantee Agency (MIGA), established in 1988, which provides insurance against certain types of risk, including political risk, primarily to the private sector.

India is a member of four of the five constituents of the World Bank Group viz., International Bank for Reconstruction and Development (IBRD), International Development Association (IDA), International Finance Corporation (IFC) and Multilateral Investment Guarantee Agency (MIGA). India is not a member of ICSID (International Centre for Settlement of Investment Disputes).

100. (d) A search light produces an intense parallel beam of light. This requires a reflector of large aperture. When a source is placed at the focus of a large concave mirror only the paraxial rays (not the marginal rays) are reflected as parallel beam, but when a source is placed at the focus of parabolic mirror all the rays are reflected as an intense parallel beam.
101. (a) ATF is **Aviation Turbine Fuel** related to Civil Aviation.
102. (c)
103. (d) Dhanush is the naval variant of the Prithvi missile.
104. (c) 105. (d) 106. (c) 107. (a) 108. (a)
109. (a) 110. (b) 111. (d) 112. (d) 113. (c)
114. (c) 115. (a)
116. (c) The Chancellor of Nalanda University resigned his post on November 25, 2016. He was taken this decision because of autonomy in the university.
117. (d) 118. (c)
119. (d) Prime Minister of Portuguese, Antonio Costa will be the Chief Guest at the 14th Pravasi Bharatiya Divas (PBD) Convention which will be held in Bengaluru from January 7 to 9, 2017. The Prime Minister will attend the inaugural function of the convention on January 8, 2017 and address the delegates.
120. (b) Senior journalist at the Times of India Akshaya Mukul has been awarded the Shakti Bhatt First Book Prize 2016. He has been awarded for his book "Gita Press and the Making of Hindu India".

ARITHMETIC

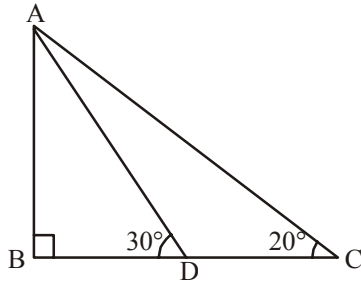
- The product of two successive numbers is 9506. Which is the smaller of the two numbers?
(a) 96 (b) 97
(c) 98 (d) 99
- What is the square root of $9 + 2\sqrt{14}$?
(a) $1 + 2\sqrt{2}$ (b) $\sqrt{3} + \sqrt{6}$
(c) $\sqrt{2} + \sqrt{7}$ (d) $\sqrt{2} + \sqrt{5}$
- There are two taps A and B to fill up a water tank. The tank can be filled in 40 min, if both taps are on. The same tank can be filled in 60 min, if tap A alone is on. How much time will tap B alone take, to fill up the same tank?
(a) 64 min (b) 80 min
(c) 96 min (d) 120 min
- In how many different ways can the letters of the word DESIGN be arranged so that the vowels are at the two ends?
(a) 48 (b) 72
(c) 36 (d) 24
- Distance between point P and Q is 480 km. A train starts from point P at 6:00 AM with 60 km/hr towards Q . Another train starts from point Q towards P at 7:00 AM with 80 km/hr. At what time the trains will meet?
(a) 9:40 AM (b) 10:30 AM
(c) 10:00 AM (d) 11:00 AM
- Naresh purchased a TV set for ₹11,250 after getting discount of 10% on the labelled price. He spent ₹150 on transport and ₹800 on installation. At what price should it be sold so that the profit earned would be 15% if no discount was offered?
(a) ₹ 12,937.50 (b) ₹ 14,030
(c) ₹ 13,450 (d) ₹ 15,467.50
- If $P : Q = \frac{3}{5} : \frac{5}{7}$ and $Q : R = \frac{3}{4} : \frac{2}{5}$, then what is $P : Q : R$ equal to?
(a) $\frac{3}{5} : \frac{5}{7} : \frac{2}{5}$ (b) $\frac{9}{20} : \frac{15}{28} : \frac{2}{7}$
(c) $\frac{3}{5} : \frac{3}{4} : \frac{2}{5}$ (d) $\frac{3}{5} : \frac{5}{7} : \frac{3}{4}$
- Arun invested a sum of money at a certain rate of simple interest for a period of four years. Had he invested the same sum at the same rate for a period of six years, the total interest earned by him would have been fifty per cent more than the earlier interest amount. What was the rate of interest per cent per annum?
(a) 4
(b) 8
(c) 5
(d) Cannot be determined
- Two-thirds of three-fourths of one-fifth of a number is 15. What is 30 per cent of that number?
(a) 45 (b) 60 (c) 75 (d) 30
- The sum of the circumference of a circle and the perimeter of a square is equal to 272 cm. The diameter of the circle is 56 cm. What is the sum of the areas of the circle and the square?
(a) 2464 sq cm
(b) 2644 sq cm
(c) 3040 sq cm
(d) Cannot be determined
- 

In the given figure, $\angle ABD = 90^\circ$, $\angle BDA = 30^\circ$ and $\angle BCA = 20^\circ$. What is $\angle CAD$?
(a) 10° (b) 20° (c) 30° (d) 15°

12. In the figure given above, YAX is a tangent to the circle with centre O . If $\angle BAX = 70^\circ$ and $\angle BAQ = 40^\circ$, then what is $\angle ABQ$ equal to?

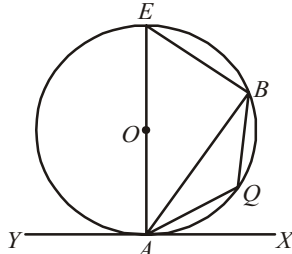

- (a) 20° (b) 30° (c) 35° (d) 40°
13. The diameter of two circles are 18 cm and 8 cm. The distance between their centres is 13 cm. What is the number of common tangents?
 (a) 1 (b) 2
 (c) 3 (d) None of these
14. A parallelogram and a rectangle stand on the same base and on the same side of the base with the same height. If I_1, I_2 be the perimeters of the parallelogram and the rectangle respectively, then which one of the following is correct?
 (a) $I_1 < I_2$ (b) $I_1 = I_2$
 (c) $I_1 > I_2$ but $I_1 \neq 2I_2$ (d) $I_1 = 2I_2$
15. If $3.7^x = 0.037^y = 10000$, then what is the value of $\frac{1}{x} - \frac{1}{y}$?
 (a) 1 (b) 2
 (c) $1/2$ (d) $1/4$
16. If $3^x + 27(3^{-x}) = 12$, then what is the value of x ?
 (a) 4 (b) 3
 (c) 1 or 2 (d) 0 or 1
17. The expression $\sin^2 x + \cos^2 x - 1 = 0$ is satisfied by how many values of x ?
 (a) Only one value of x (b) Two values of x
 (c) Infinite values of x (d) No value of x
18. If $\cos A = \tan B$, $\cos B = \tan C$ and $\cos C = \tan A$ then $\sin^2 A$ is equal to
 (a) $\frac{\sqrt{5}-1}{4}$ (b) $\frac{\sqrt{5}-1}{2}$
 (c) $\frac{3-\sqrt{5}}{2}$ (d) $\frac{\sqrt{3}-1}{2}$
19. If $\sin x + \cos x = c$ then $\sin^6 x + \cos^6 x$ is equal to
 (a) $\frac{1-6c^2-3c^4}{16}$ (b) $\frac{1+6c^2-3c^4}{4}$
 (c) $\frac{1-6c^2-3c^4}{16}$ (d) $\frac{1-6c^2-3c^4}{4}$

DIRECTIONS (Qs. 20-22): Study the following Pie-chart carefully and answer the questions given below:

A survey conducted on 5800 villagers staying in various villages and having various favourite fruits.

Favourite Fruits

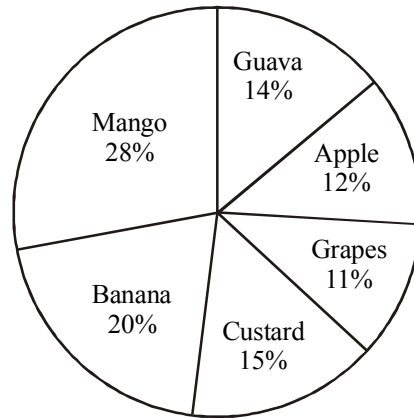

People staying in various villages

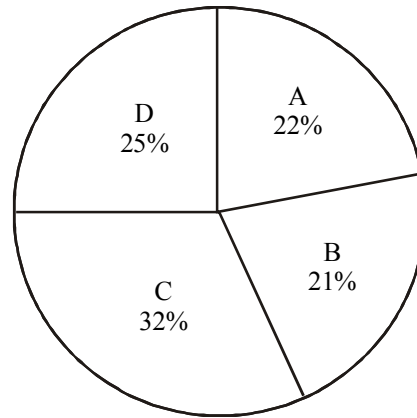

20. Mango is the favourite fruit of 50% of the people from village C. People having their favourite fruit as mango from village C form approximately what per cent of the people having their favorite fruit as mango from all the villages together?
 (a) 48 (b) 53
 (c) 61 (d) 57
21. 20% of the people from village D have banana as their favourite fruit and 12% of the people from the same village have guava as their favourite fruit. How many people from that village like other fruits?
 (a) 764 (b) 896
 (c) 874 (d) 986

22. How many people in all have custard as their favourite fruit?
 (a) 850 (b) 864
 (c) 870 (d) 812
23. A hollow cylindrical iron pipe of length 1.4 m has base radius 2.5 cm and thickness of the metal is 1 cm. What is the volume of the iron used in the pipe?
 (a) 2640 cu cm (b) 2604 cu cm
 (c) 2460 cu cm (d) None of these
24. A solid metallic cube of edge 4 cm is melted and recast into solid cubes of edge 1 cm. If x is the surface area of the melted cube and y is the total surface area of all the cubes recast, then what is $x : y$?
 (a) 2 : 1 (b) 1 : 2
 (c) 1 : 4 (d) 4 : 1
25. The angle of elevation of the top of a tower 30 m high from the foot of another tower in the same plane is 60° and the angle of elevation of the top of the second tower from the foot of the first tower is 30° . The distance between the two towers is m times the height of the shorter tower. What is m equal to?
 (a) $\sqrt{2}$ (b) $\sqrt{3}$
 (c) $\frac{1}{2}$ (d) $\frac{1}{3}$
26. When 60 is subtracted from 60% of a number, the result is 60. The number is :
 (a) 120 (b) 150
 (c) 180 (d) 200
27. $\sqrt{110.25} \times \sqrt{0.01} \div \sqrt{0.0025} - \sqrt{420.25}$ equals to:
 (a) 0.75 (b) 0.50
 (c) 0.64 (d) 0.73
28. The traffic lights at three different road crossings change after every 48 seconds, 72 seconds and 108 seconds respectively. If they all change simultaneously at 8 : 20 hours, then at what time will they again change simultaneously ?
 (a) 8 : 20 : 08 hrs (b) 8 : 24 : 10 hrs
 (c) 8 : 27 : 12 hrs (d) 8 : 30 : 15 hrs
29. The average marks of 65 students in a class was calculated as 150. It was later realised that the marks of one of the students was calculated as 142, whereas his actual marks were 152. What is the actual average marks of the group of 65 students ? (Rounded off to two digits after decimal)
 (a) 151.25 (b) 150.15
 (c) 151.10 (d) 150.19
30. A man buys 50 pencils for ₹ 100 and sells 45 pencils for ₹ 90. Find his gain or loss %.
 (a) 20% (b) 35%
 (c) 25% (d) No gain or loss
31. Find a fractions which shall bear the same ratio to $\frac{1}{27}$ that $\frac{3}{11}$ does to $\frac{5}{9}$.
 (a) 1 : 27 (b) 1 : 45
 (c) 1 : 55 (d) 1 : 65
32. A is 30% more efficient than B. How much time will they, working together, take to complete a job which A alone could have done in 23 days?
 (a) 11 days (b) 13 days
 (c) $20\frac{3}{17}$ days (d) None of these
33. In a 800 m race around a stadium having the circumference of 200 m, the top runner meets the last runner on the 5th minute of the race. If the top runner runs at twice the speed of the last runner, what is the time taken by the top runner to finish the race ?
 (a) 20min (b) 15min
 (c) 10min (d) 5min
34. A rectangular parking space is marked out by painting three of its sides. If the length of the unpainted side is 9 feet, and the sum of the lengths of the painted sides is 37 feet, then what is the area of the parking space in square feet?
 (a) 46 (b) 81
 (c) 126 (d) 252
35. The list price of a watch is ₹ 160. A retailer bought the same watch ₹ 122.40. He got two successive discounts one at 10% and the other at a rate which was not legible. What is the second discount rate?
 (a) 12% (b) 14%
 (c) 15% (d) 18%
36. 4 pipes can fill a reservoir in 15, 20, 30 and 60 hours respectively. The first was opened at 6 am, second at 7 am third at 8 am and fourth at 9 am. When will the reservoir be full ?
 (a) 11 am (b) 12 pm
 (c) 12.30 pm (d) 1.00 pm
37. Points A and B are 70 km apart on a highway. One car starts from A and the another one from B at the same time. If they travel in the same direction, they meet in 7 hours. But if they travel towards each other, they meet in one hour. The speeds of the two cars are, respectively.
 (a) 45 and 25 km/h (b) 70 and 10 km/h
 (c) 40 and 30 km/h (d) 60 and 40 km/h

38. If $3x + 7 = x^2 + P = 7x + 5$, what is the value of P ?
- (a) $\frac{1}{2}$
 (b) $8\frac{1}{4}$
 (c) $8\frac{1}{2}$
 (d) Cannot be determined
39. If $x_2 - 3x + 1 = 0$, then the value of $x^3 + \frac{1}{x^3}$ is
- (a) 9 (b) 18
 (c) 27 (d) 1
40. If $x \sin^3 \theta + y \cos^3 \theta = \sin \theta \cos \theta \neq 0$ and $x \sin \theta - y \cos \theta = 0$, then value of $(x^2 + y^2)$ is
- (a) $\sin \theta - \cos \theta$ (b) $\sin \theta + \cos \theta$
 (c) 0 (d) 1

GENERAL INTELLIGENCE & REASONING

DIRECTIONS (Qs. 41-43): In questions below, select the related word/letter/number/figure from the given alternatives.

41. King : Palace :: Eskimo : ?
 (a) Caravan (b) Asylum
 (c) Monastery (d) Igloo
42. AFKP : DINS :: WBGL : ?
 (a) ORUX (b) OSWA
 (c) OTYD (d) OQSU
43. 12 : 20 :: ?
 (a) 15 : 37 (b) 16 : 64
 (c) 27 : 48 (d) 30 : 42

DIRECTIONS (Qs. 44-45): In questions below, find the odd number/letters/number pair from the given alternatives.

44. (a) (47,49) (b) (5,7)
 (c) (29,31) (d) (11,13)
45. (a) Marigold (b) Lotus
 (c) Tulip (d) Rose

DIRECTIONS (Qs. 46 to 47): Complete the given series.

46. BDF, CFI, DHL, ?
 (a) CJM (b) EIM
 (c) EJO (d) EMI
47. 1, 3, 8, 19, 42, 89, ?
 (a) 108 (b) 184
 (c) 167 (d) 97

48. In a certain code DEPUTATION is written as ONTADEPUTI. How is DERIVATION written in that code ?
 (a) ONVADERITI (b) ONDEVARITI
 (c) ONVAEDIRITI (d) ONVADEIRIT
49. Arrange the following words as per order in the dictionary.
 1. Forecast 2. Forget 3. Foreign 4. Forsook
 5. Force
 (a) 3, 5, 1, 2, 4 (b) 5, 1, 3, 2, 4
 (c) 5, 1, 3, 4, 2 (d) 5, 1, 2, 3, 4

DIRECTIONS (Qs. 50) : In question which one set of letters/ numbers when sequentially placed at the gaps in the given series shall complete it?

50. a _ c d d _ b c d _ a b c _ d a b _
 (a) b a d d c (b) a b d d c
 (c) b a d c d (d) b d a d c
51. Sohan ranks seventh from the top and twenty-sixth from the bottom in a class. How many students are there in the class ?
 (a) 33 (b) 34
 (c) 31 (d) 32
52. Keeping his back towards the rising sun, Reshma starts walking. After a few minutes, she turns left and keeps on walking. Then a little later she turns right and then left. In which direction is she going at the moment?
 (a) East or South (b) South or West
 (c) North or South (d) West or North
53. Seema's younger brother Sohan is older than Seeta. Sweta is younger than Deepti but elder than Seema. Who is the eldest ?
 (a) Seeta (b) Deepti
 (c) Seema (d) Sweta
54. In the given figure in a garden, square represent the area where jackfruit trees are grown, circle represent mango trees and triangle represent coconut trees. Which number represent the common area in which all types of trees are grown.

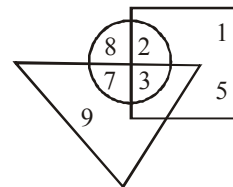

- (a) 4 (b) 3
 (c) 7 (d) 8
55. If 'a' represents \div , 'b' represents $+$, 'c' represents $-$ and 'd' represents \times then $24a 6d 4b 9c 8 = ?$
 (a) 6 (b) 17
 (c) 20 (d) 19

56. Mani is double the age of Prabhu. Ramona is half the age of Prabhu. If Mani is sixty, find out the age of Ramona.
- (a) 20 (b) 15
(c) 10 (d) 24

DIRECTIONS (Qs. 57-58) : In questions below, Select the missing number from the given responses.

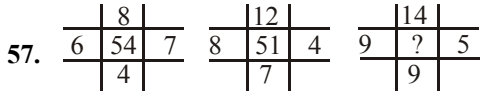

- (a) 53 (b) 71
(c) 76 (d) 68

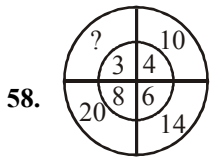

- (a) 24 (b) 12
(c) 18 (d) 19

59. How many triangles are there in the following figure?

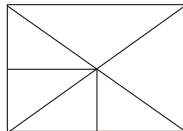

- (a) 12 (b) 8
(c) 16 (d) 15

60. Four positions of a dice are given below. Find out the opposite surface of 6.

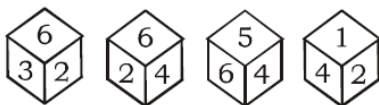

- (a) 2 (b) 3
(c) 1 (d) 5

DIRECTION: In question nos. 61 two statements are given followed by some conclusions. You have to consider the statements to be true even if they seem to be at variance from commonly known facts. You are to decide which of the given conclusion, if any, follow from the given statements.

61. Statements :

1. All students are doctors.
2. No doctor is leader.

Conclusions :

- I. All leaders are students.
 - II. Some doctors are students.
- (a) Only conclusion I follows
(b) Only conclusion II follows
(c) Both conclusions I and II follows
(d) Neither conclusion I nor II follows

DIRECTIONS (Qs. 62-63) : In questions below, which answer figure will complete the pattern in the question figure ?

62. Question figure :

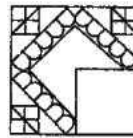

Answer figures :

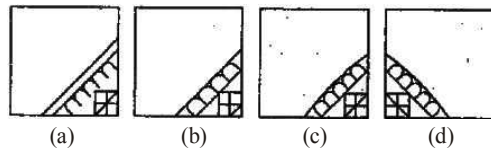

63. A piece of paper is folded and cut as shown below in the question figures. From the given answer figures, indicate how it will appear when opened.

Question figure :

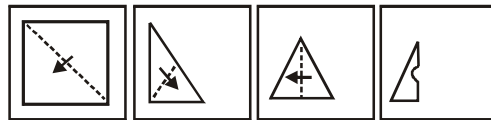

Answer figures:

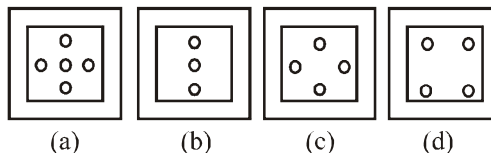

64. From the given answer figures, select the one in which the question figure is hidden/embedded.

Question figure :

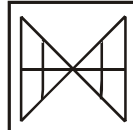

Answer figures:

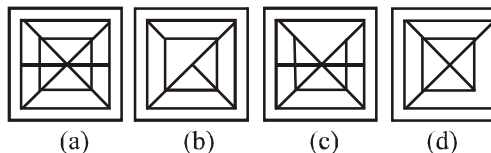

65. A word is represented by only one set of numbers as given in any one of the alternatives. The sets of numbers given in the alternatives are represented by two classes of alphabets as in two matrices given below. The columns and rows of Matrix - I are numbered from 0 to 4 and that of Matrix - II are numbered from 5 to 9. A letter from these matrices can be represented first by its row and next by its column, e.g., A can be represented by 01, 20, 42 etc. and H can be represented by 65, 57, 98 etc. Similarly, you have to identify the set for the word given in the question.

FAITH

Matrix-I

	0	1	2	3	4
0	F	A	N	O	I
1	I	O	F	A	N
2	A	N	O	I	F
3	O	F	I	N	A
4	N	I	A	F	O

Matrix-II

	5	6	7	8	9
5	S	E	H	B	T
6	H	S	E	T	B
7	B	T	S	E	H
8	E	H	T	B	S
9	T	S	E	H	B

- (a) 24, 31, 10, 59, 57 (b) 12, 20, 40, 68, 65
(c) 31, 34, 23, 76, 79 (d) 43, 42, 41, 78, 89
66. If in a certain language LATE is coded as 8 & 4 \$ and HIRE is coded as 7*3\$ then how will HAIL be coded in the same language?
(a) 7 & 8* (b) &7*8
(c) 7*& 8 (d) 7&*8
67. Four of the following five are alike in a certain way and so form a group. Which is the one that does not belong to that group?
(a) Stem (b) Tree
(c) Root (d) Branch
68. If 'Apple' is called 'Orange', 'Orange' is called 'Peach', 'Peach' is called 'Potato', 'Potato' is called 'Banana', 'Banana' is called 'Papaya' and 'Papaya' is called 'Guava', which of the following grows underground?
(a) Potato (b) Guava
(c) Apple (d) Banana

69. How many such pairs of letters are there in word ENGLISH, each of which has as many letters between its two letters as there are between them in the English alphabets?

(a) None (b) One
(c) Two (d) More than three

DIRECTIONS (Qs. 70-72) : Read the following information carefully and answer the questions, which follow :

'A - B' means 'A is father of B'.

'A + B' means 'A is daughter of B'.

'A ÷ B' means 'A is son of B'.

'A × B' means 'A is wife of B'.

70. How is P related to T in the expression 'P + S - T' ?
(a) Sister (b) Wife
(c) Son (d) Daughter
71. In the expression 'P × Q - T' how is T related to P ?
(a) Daughter (b) Sister
(c) Mother (d) Can't be determined
72. Which of the following means T is wife of P ?
(a) P × S ÷ T (b) P ÷ S × T
(c) P - S ÷ T (d) None of these

DIRECTIONS (Q. 73-75) : Study the following arrangement carefully and answer the questions given below

D 5 δ R @ A K © 3 9 B J E F \$ M P I
4 H 1 W 6 2 # U Q 8 T N

73. How many such numbers are there in the above arrangement each of which is immediately preceded by a symbol and immediately followed by a letter?
(a) None (b) One
(c) Two (d) Three
74. Which of the following is the ninth to the right of the twenty second from the right end of the above arrangement?
(a) E (b) I (c) D (d) N
75. How many such symbols are there in the above arrangement each of which is immediately preceded by a number and immediately followed by a letter?
(a) None (b) One
(c) Two (d) Three

DIRECTIONS (Q. 76-78) : Study the following arrangement carefully and answer the questions given below

M, D, K, R, T, H, W and A are sitting around a circle facing at the centre. D is second to the right of M who is fifth to the left of T. K is third to the right of R who is second to the right of D. H is second to the right of W.

76. Who is second to the right of A ?
 (a) M (b) D
 (c) K (d) Data inadequate
77. Who is third to the left of M ?
 (a) A (b) T
 (c) H (d) D
78. Who is fourth to the right of H ?
 (a) A (b) T
 (c) R (d) K
79. If all the numbers are dropped from the above arrangement, which of the following will be the eleventh from the left end ?
 (a) B (b) H (c) \$ (d)
80. How many such consonants are there in the above arrangement each of which is immediately preceded by a number and immediately followed by another consonant ?
 (a) None (b) One
 (c) Two (d) Three

GENERAL AWARENESS

81. Who among the following had founded the Theosophical Society in the United States of America?
 (a) Swami Dayanand Saraswati
 (b) Madam Blavatsky
 (c) Madam Cama
 (d) Lala Hardayal
82. 'Freon' used as refrigerants is chemically known as
 (a) chlorinated hydrocarbon
 (b) fluorinated hydrocarbon
 (c) chlorofluoro hydrocarbon
 (d) fluorinated aromatic compound
83. The humidity of air measured in percentage is called
 (a) absolute humidity (b) specific humidity
 (c) relative humidity (d) all of these
84. In which of the following years was the first Railway line between Bombay and Thane laid?
 (a) 1853 (b) 1854 (c) 1856 (d) 1858
85. Which one of the following was the original name of Tansen, the famous musician in the court of Akbar?
 (a) Mahananda Pande (b) Lal Kalwant
 (c) Baz Bahadur (d) Ramtanu Pande
86. When the productive capacity of the economic systems of a state is inadequate to create sufficient number of jobs, it is called
 (a) seasonal unemployment
 (b) structural unemployment
 (c) disguised unemployment
 (d) cyclical unemployment
87. Who of the following constitutes a Finance Commission for a State in India?
 (a) The President of India
 (b) The Governor of the State
 (c) The Union Finance Minister
 (d) The Union Cabinet
88. Who drafted the Constitution of Muslim League, 'The Green Book'?
 (a) Rahamat Ali
 (b) Muhammad Iqbal
 (c) Muhammad Ali Jinnah
 (d) Maulana Muhammad Ali Jauhar
89. Bluetooth technology allows
 (a) wireless communications between equipments
 (b) signal transmission on mobile phones only
 (c) landline to mobile phone communication
 (d) satellite television communication
90. The 'Arthashastra' is a treatise on which one of the following?
 (a) Economics
 (b) Environment
 (c) Political Philosophy
 (d) Religion in Administration
91. Who among the following was the Viceroy of India at the time of the formation of Indian National Congress?
 (a) Lord Mayo (b) Lord Ripon
 (c) Lord Dufferin (d) Lord Lansdowne
92. As which one of the following, does carbon occur in its purest form in nature?
 (a) Carbon black (b) Graphite
 (c) Diamond (d) Coal
93. Whose philosophy is called the Advaita?
 (a) Ramanujacharya (b) Shankaracharya
 (c) Nagarjuna (d) Vasumitra
94. Special Drawing Rights [SDRs] relate to
 (a) the World Bank
 (b) the Reserve Bank of India
 (c) the World Trade Organisation
 (d) the International Monetary Fund
95. The income elasticity of demand for inferior goods is
 (a) less than one (b) less than zero
 (c) equal to one (d) greater than one
96. Which schedule of the Constitution of India contains the three lists that divide powers between the Union and the states?
 (a) Fifth (b) Sixth (c) Seventh (d) Eighth
97. In which part of the Constitution, details of citizenship are mentioned?
 (a) I (b) II (c) III (d) IV
98. In which one of the following Indian States is the game of polo said to have originated?
 (a) West Bengal (b) Meghalaya
 (c) Manipur (d) Sikkim

99. 'And Then One Day : A Memoir' is an autobiography of
(a) Kamal Hasan (b) Shahrukh Khan
(c) Naseeruddin Shah (d) Karan Johar
100. Which one of the following diseases is caused by virus?
(a) Tuberculosis (b) Typhoid
(c) Influenza (d) Diphtheria
101. Movement of cell against concentration gradient is called
(a) osmosis (b) active transport
(c) diffusion (d) passive transport
102. Prokaryotic cells lack
(a) nucleolus
(b) nuclear membrane
(c) membrane bound by organelles
(d) All of these
103. Plants that grow in saline water are called
(a) halophytes (b) hydrophytes
(c) mesophytes (d) thallophytes
104. The Juno spacecraft which successfully entered the Jupiter orbit recently belonged to which space agency?
(a) National Aeronautics and Space Administration
(b) European Space Agency
(c) Japan Aerospace Exploration Agency
(d) China National Space Administration
105. The 2016 National Doctors' Day that was observed recently is observed to honour which of the following legendary physicians?
(a) Sushruta
(b) Ronald Ross
(c) Kadambini Ganguly
(d) Bidhan Chandra Roy
106. How many options does a binary choice offer?
(a) One
(b) Two
(c) Three
(d) It depends on the amount of memory in the computer
107. Which menu is selected to cut, copy, and paste?
(a) File (b) Edit
(c) Tools (d) Table
108. Storage device, inside the computer is
(a) CDROM (b) Zip Disk
(c) Super Disk (d) Hard Disk
109. The indicates how much data a particular storage medium can hold.
(a) access (b) capacity
(c) memory (d) storage
110. If you are going to a site you use often, instead of having to type in the address every time, you should
(a) save it as a file (b) make a copy of it
(c) bookmark it (d) delete it
111. Through which of the following group of states does the Konkan Railways run?
(a) Maharashtra - Karnataka - Andhra Pradesh - Kerala
(b) Maharashtra - Karnataka - Goa - Kerala
(c) Maharashtra - Karnataka - Kerala - Tamil Nadu
(d) Karnataka - Goa - Kerala - Tamil Nadu
112. Which of the following zonal headquarters - city combination is incorrect?
(a) South East Central - Bilaspur
(b) North Western - Jodhpur
(c) East Central - Hajipur
(d) West Central - Jabalpur
113. Which of the following zones administers the Matheran Hill Railway?
(a) Konkan Railways (b) Western Railways
(c) Central Railways (d) Southern Railways
114. In which city is the Indian Railway Institute of Financial Management (IRIFM) being set up as announced in the Railway Budget 2013?
(a) Secunderabad (b) Lucknow
(c) Rae Bareilly (d) Gurgaon
115. In which of the following cities is the National Rail Museum located?
(a) Mumbai (b) New Delhi
(c) Hyderabad (d) Chennai
116. The Surrogacy (Regulation) Bill, 2016 was passed in Lok Sabha on November 21, 2016 by Health Minister of India. Who is the present Health Minister of India?
(a) J P Nadda
(b) Kalraj Mishra
(c) Nitin Jairam Gadkari
(d) Dr. Harsh Vardhan
117. Uttar Pradesh Chief Minister Akhilesh Yadav on November 21, 2016 inaugurated India's longest expressway between which two Indian cities?
(a) Agra - Varanasi (b) Agra - Lucknow
(c) Varanasi - Noida (d) Noida - Lucknow
118. Tiger National Parks Of Central India has been named under which category of 'Best of the World List 2017' by National Geographic?
(a) Nature (b) Cities
(c) Culture (d) Wildlife
119. 'Women in India: Unheard Stories' a virtual artwork and exhibition was organized by which firm on November 19 2016 ?
(a) IBM (b) TCS
(c) Google (d) Microsoft
120. The Indore-Patna Express train derailment accident on November 21, 2016 took place at which place of Kanpur Dehat?
(a) Rania (b) Jhijnhak
(c) Rura (d) Pukhrayan

Hints & Explanations

1. (b) From the given alternatives,
 $97 \times 98 = 9506$
 \therefore Smaller number = 97

2. (c) $9 \quad 2\sqrt{14} \quad \sqrt{7}^2 \quad \sqrt{2}^2 \quad 2\sqrt{7} \times \sqrt{2}$
 $= \sqrt{7} \quad \sqrt{2}^2$
 $\therefore \quad \sqrt{9} \quad 2\sqrt{14} \quad \sqrt{7} \quad \sqrt{2}$

3. (d) Work done by tap B in 1 min
 $= \frac{1}{40} - \frac{1}{60} = \frac{3-2}{120} = \frac{1}{120}$

Total time taken by the tap B to fill the tank is 120 min.

4. (a) Required no. of ways
 $= {}^2P_2 \times {}^4P_4 = 48$

5. (c) When 2nd train starts i.e. at 7 AM (1 hr after 6 AM), distance covered by first train is 60 km (i.e. in 1 hr).

Now 2nd train also starts and distance between them is now $(480-60) = 420$ km

Both coming in opposite direction, so relative speed = $(60+80) = 140$ km/hr

So time = 7:00 AM + $(420/140) = 7:00$ AM + 3 hrs = 10:00 AM

6. (d) Cost price of TV when discount is not offered

$$= 11250 \times \frac{100}{90} = ₹12500$$

Total cost of TV after transport and installation

$$= 12500 + 800 + 150 = ₹13450$$

To earn 15% profit, he must sell at

$$13450 \times \frac{115}{100} = ₹15467.50$$

7. (b) Given, $P : Q = \frac{3}{5} : \frac{5}{7}$... (i)

$$Q : R = \frac{3}{4} : \frac{2}{5} \quad \dots \text{(ii)}$$

From Eq. (i),

$$P : Q = \frac{3}{5} \times \frac{3}{4} : \frac{5}{7} \times \frac{3}{4}$$

$$= \frac{9}{20} : \frac{15}{28} \quad \dots \text{(iii)}$$

From Eq. (ii),

$$Q : R = \frac{3}{4} \times \frac{5}{7} : \frac{2}{5} \times \frac{5}{7}$$

$$= \frac{15}{28} : \frac{2}{7} \quad \dots \text{(iv)}$$

From equations (iii) and (iv),

$$P : Q : R = \frac{9}{20} : \frac{15}{28} : \frac{2}{7}$$

8. (d)

9. (a) $\frac{2}{3} \times \frac{3}{4} \times \frac{1}{5} \times a = 15$; $a = \text{Number}$
 $\Rightarrow a = 150$

$$\text{Then } 30\% \text{ of } a = \frac{30}{100} \times 150 = 45$$

10. (c) Circumference of the circle
 $= \pi \times \text{diameter}$

$$= \frac{22}{7} \times 56 = 176 \text{ cm}$$

\therefore Perimeter of the square

$$= (272 - 176) = 96 \text{ cm}$$

\therefore Side of the square

$$= \left(\frac{96}{4} \right) = 24 \text{ cm}$$

\therefore Area of the square

$$= (24 \times 24) = 576 \text{ sq cm}$$

\therefore Area of the circle = πr^2

$$= \frac{22}{7} \times 28 \times 28 = 2464 \text{ sq cm.}$$

\therefore Required sum

$$= (576 + 2464) \text{ sq cm} = 3040 \text{ sq cm}$$

11. (a) In $\triangle ADC$,

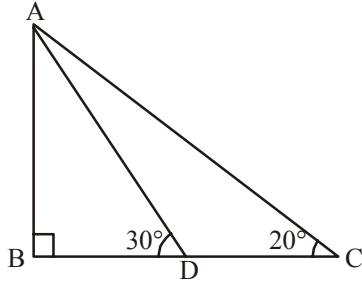

$$\angle ADC = 180^\circ - 30^\circ = 150^\circ$$

$$\therefore \angle DAC = 180^\circ - (150^\circ + 20^\circ) = 10^\circ$$

12. (b) Given, $\angle BAX = 70^\circ$ and $\angle BAQ = 40^\circ$

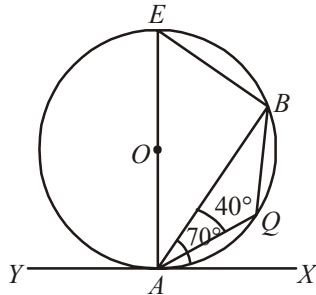

$$\angle QAX = 70^\circ - 40^\circ = 30^\circ$$

$$\therefore \angle EAX = 90^\circ$$

$$\Rightarrow \angle EAB = 90^\circ - 70^\circ = 20^\circ$$

Since, $AQBE$ is a cyclic quadrilateral.

$$\therefore \angle EAQ + \angle EBQ = 180^\circ$$

$$\Rightarrow \angle EBQ = 180^\circ - 60^\circ = 120^\circ$$

$$\text{But } \angle EBA = 90^\circ$$

$$\therefore \angle ABQ = 120^\circ - 90^\circ = 30^\circ$$

13. (c) Here, $r_1 = 9$ cm and $r_2 = 4$ cm

$$r_1 + r_2 = 9 + 4 = 13 \text{ cm}$$

$$\text{and } r_1 - r_2 = 9 - 4 = 5 \text{ cm}$$

$$\text{Also, } d = 13 \text{ cm}$$

$$\text{Here, } d = r_1 + r_2 = 13 \text{ cm}$$

Hence, two circles touch each other externally, so there are three common tangents.

14. (c) If a parallelogram and a rectangle stand on the same base and on the same side of the base with the same height, then perimeter of parallelogram is greater than perimeter of rectangle.

$$\therefore I_1 > I_2$$

15. (c) Given, $3.7^x = 0.037^y = 10000$

$$\Rightarrow 3.7^x = 10^4 \text{ and } 0.037^y = 10^4$$

$$\Rightarrow 37 \cdot 10^x = 1 \text{ and } 37 \cdot 10^y = 3$$

$$\Rightarrow 10^x = \frac{1}{37} \text{ and } 10^y = \frac{3}{37}$$

$$\therefore \frac{4}{x} - \frac{4}{y} = 3 - 1 \Rightarrow \frac{1}{x} - \frac{1}{y} = \frac{1}{2}$$

16. (c) Given, $3^x + 27(3^{-x}) = 12$

$$\text{Let } 3^x = y$$

$$\therefore y + \frac{27}{y} = 12$$

$$\Rightarrow y^2 - 12y + 27 = 0$$

$$\Rightarrow y^2 - 9y - 3y + 27 = 0$$

$$\Rightarrow (y - 3)(y - 9) = 0 \Rightarrow y = 3, 9$$

$$\text{when } y = 3;$$

$$\text{when } y = 9$$

$$\Rightarrow 3^x = 3$$

$$3^x = 9$$

$$\therefore x = 1$$

$$x = 2$$

$x = 1, 2$ are value of x .

17. (c) Given that, $\sin^2 x + \cos^2 x - 1 = 0$

$$\Rightarrow \sin^2 x + \cos^2 x = 1$$

which is an identity of trigonometric ratio and always true for every real value of x .

Therefore, the equation has an infinite solution.

18. (c) $\cos A = \tan B$

Squaring on both sides

$$\cos^2 A = \tan^2 B$$

$$\Rightarrow \tan^2 B = \frac{\sin^2 B}{\cos^2 B} = \frac{1 - \cos^2 B}{\cos^2 B}$$

$$\therefore \cos^2 A = \frac{1 - \cos^2 B}{\cos^2 B}$$

$$\cos^2 A = \frac{1 - \tan^2 C}{\tan^2 C}$$

$$\therefore \cos B = \tan C$$

$$\Rightarrow \cos^2 A \tan^2 C = 1 - \tan^2 C = 1 - \frac{\sin^2 C}{\cos^2 C}$$

$$\Rightarrow \cos^2 A \frac{\sin^2 C}{\cos^2 C} = \frac{\cos^2 C - \sin^2 C}{\cos^2 C}$$

$$\Rightarrow \cos^2 A (1 - \cos^2 C) = 2 \cos^2 C - 1$$

$$\Rightarrow \cos^2 A (1 - \tan^2 A) = 2 \tan^2 A - 1$$

$$\cos^2 A - \sin^2 A = \frac{2 \sin^2 A}{\cos^2 A} - 1$$

$$\Rightarrow 1 - 2 \sin^2 A = \frac{2 \sin^2 A - \cos^2 A}{\cos^2 A}$$

$$\Rightarrow \cos^2 A (1 - 2 \sin^2 A) = 2 \sin^2 A - \cos^2 A$$

$$\Rightarrow \cos^2 A (1 - 2 \sin^2 A) = 2 \sin^2 A - 1 + \sin^2 A$$

$$\Rightarrow (1 - \sin^2 A) (1 - 2 \sin^2 A) = 3 \sin^2 A - 1$$

$$\Rightarrow 1 - 2 \sin^2 A - \sin^2 A + 2 \sin^4 A = 3 \sin^2 A - 1$$

$$\Rightarrow 1 - 3 \sin^2 A + 2 \sin^4 A = 3 \sin^2 A - 1$$

$$\Rightarrow 2 \sin^4 A - 6 \sin^2 A + 2 = 0$$

$$\Rightarrow \sin^4 A - 3 \sin^2 A + 1 = 0$$

This is quadratic equation in $\sin^2 A$

$$(\sin^2 A)^2 - 3(\sin^2 A) + 1 = 0$$

$$\sin^2 A = \frac{3 \pm \sqrt{3^2 - 4 \cdot 1 \cdot 1}}{2}$$

$$\frac{3 + \sqrt{5}}{2}$$

$$\sin^2 A = \frac{3 + \sqrt{5}}{2} \text{ not possible because}$$

$$\sin^2 A \neq 1$$

$$\text{So } \sin^2 A = \frac{3 - \sqrt{5}}{2}$$

So none of the options are correct.

19. (b) $\sin x + \cos x = c$... (i)

Squaring both sides.

$$\Rightarrow \sin^2 x + \cos^2 x + 2 \sin x \cos x = c^2$$

$$\Rightarrow \sin x \cos x = \frac{c^2 - 1}{2} \quad \dots \text{(ii)}$$

Now, cubing eqn (i) both sides

$$\Rightarrow \sin^3 x + \cos^3 x + 3 \sin x \cos x (\sin x + \cos x) = c^3$$

$$\Rightarrow \sin^3 x + \cos^3 x + 3 \cdot \frac{(c^2 - 1)}{2} \times c = c^3$$

$$\Rightarrow \sin^3 x + \cos^3 x = c^3 - \frac{3}{2} (c^2 - 1) c$$

$$\Rightarrow \sin^3 x + \cos^3 x = c^3 - \frac{3c^3 - 3c}{2}$$

$$\sin^3 x - \cos^3 x = \frac{3c - c^3}{2} \quad \dots \text{(iii)}$$

On squaring both sides.

$$\Rightarrow \sin^6 x + \cos^6 x + 2 \sin^3 x \cos^3 x = \frac{(3c - c^3)^2}{4}$$

$$\Rightarrow \sin^6 x + \cos^6 x + 2$$

$$\left\{ \frac{(c^2 - 1)}{2} \right\}^3 = \frac{9c^2 - c^6 - 6c^4}{4}$$

$$\Rightarrow \sin^6 x + \cos^6 x =$$

$$\frac{9c^2 - c^6 - 6c^4 - c^6 - 1 - 3c^2(c^2 - 1)}{4}$$

$$\sin^6 x + \cos^6 x = \frac{1 - 6c^2 - 3c^4}{4}$$

20. (d) No of persons from village C

$$= 32\% \text{ of } 5800 = 1856$$

From village C 50% of 1856 = 928 persons favourite fruit is mango.

28% of 5800 = 1624 people's favourite fruit is mango

$$\therefore \text{Required \%} = \frac{928}{1624} \times 100 \approx 57\%$$

21. (d) People in village D = 25% of 5800 = 1450

\therefore Required no. of people

$$= \{100 - (20 + 12)\} \% \text{ of } 1450$$

$$= 68\% \text{ of } 1450 = 986$$

22. (c) Required no. = 15% of 5800 = 870

23. (a) \therefore Volume of pipe, $V = \pi r_1^2 - r_2^2 \times h$

$$= \frac{22}{7} [(3.5)^2 - (2.5)^2] \times 140$$

$$= \frac{22}{7} (12.25 - 6.25) \times 140$$

$$= 22 \times 6 \times 20 = 2640 \text{ cu cm}$$

24. (c) Volume of solid cube = $(4)^3 = 64 \text{ cm}^3$

$$\text{Volume of recast cube} = (1)^3 = 1 \text{ cm}^3$$

\therefore Total surface area of cube : Total surface area of recast cube = $x : y$

$$\Rightarrow x : y = 6(4)^2 : 6(1)^2 \times 64 = 1 : 4$$

25. (b) Let the height of shorter tower be h then distance between two tower = hm .

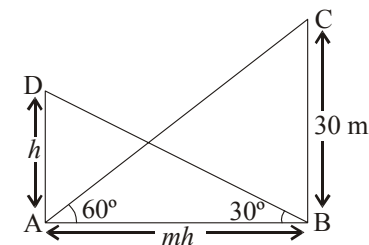

- In $\triangle ABD$, $\tan 30^\circ = \frac{h}{mh} \Rightarrow \frac{1}{\sqrt{3}} = \frac{1}{m}$
- $\therefore m = \sqrt{3}$
26. (b) Let the number be x .
Then $x - 60\%$ of $x = 60$
 $\Rightarrow x - 0.60x = 60 \Rightarrow 0.4x = 60$
 $\Rightarrow x = \frac{60}{0.4} \Rightarrow x = \frac{600}{4}$
 $x = 150$
 \therefore The number is 150.
27. (b) $\therefore \sqrt{110.25 \times \sqrt{0.01}} \div \sqrt{0.0025} - \sqrt{420.25}$
 $= 10.5 \times \frac{0.1}{0.05} - 20.5 = \frac{1.05}{0.05} - 20.5 = 21 - 20.5$
 $= 0.5$
28. (c) The traffic lights will again change at three different road crossings simultaneously after the LCM of 48, 72 and 108
i.e., after every (432 sec) 7 minutes and 12 seconds, i.e. the earliest at 8 : 27 : 12 hours.
29. (b) Actual average marks
 $= \frac{65 \times 150 + 152 - 142}{65} = \frac{9750 - 10}{65} = 150.15$
30. (d) C. P. for 50 pencils = ₹ 100
 \therefore C. P. for 45 pencils = $\frac{100}{50} \times 45 = ₹ 90$
= S.P. of 45 pencils
 \therefore No gain, no loss
31. (c) $x : \frac{1}{27} = \frac{3}{11} : \frac{5}{9}$ or, $27x = \frac{3 \times 9}{11 \times 5} \therefore x = \frac{1}{55}$
32. (b) Ratio of times taken by A and B = 100 : 130 = 10 : 13.
Suppose B takes x days to do the work.
Then, 10 : 13 :: 23 : x
 $\Rightarrow x = \left(\frac{23 \times 13}{10} \right) \Rightarrow x = \frac{299}{10}$
A's 1 day's work = $\frac{1}{23}$; B's 1 day's work
 $= \frac{10}{299}$.
(A+B)'s 1 day's work
 $= \left(\frac{1}{23} + \frac{10}{299} \right) = \frac{23}{299} + \frac{1}{13}$
 \therefore A and B together can complete the job in 13 days.
33. (c) After 5 minutes (before meeting), the top runner covers 2 rounds i.e., 400 m and the last runner covers 1 round i.e., 200 m.
 \therefore Top runner covers 800 m race in 10 minutes.
34. (c) Clearly, we have : $l = 9$ and $l + 2b = 37$ or $b = 14$.
 \therefore Area = $(l \times b) = (9 \times 14)$ sq. ft. = 126 sq. ft.
35. (c) Retailer price = list price
 $\left(1 - \frac{d_1}{100} \right) \left(1 - \frac{d_2}{100} \right)$
 $\Rightarrow 122.40 = 160 \left(1 - \frac{10}{100} \right) \left(1 - \frac{d_2}{100} \right)$
 $\Rightarrow 1 - \frac{d_2}{100} = \frac{122.40 \times 100}{160 \times 90} = 0.85$
 $\Rightarrow d_2 = (1 - 0.85) \times 100 = 15\%$
36. (d) Let the time be t hours after 6 am.
 $\therefore \frac{1}{15} \times t = \frac{(t-1)}{20} + \frac{(t-2)}{30} + \frac{(t-3)}{60} = 1$
 $\therefore 4t + 3(t-1) + 2(t-2) + (t-3) = 60$
 $\therefore t = 7$ hours \therefore It is filled at 1 pm
37. (c) Let the speed of the cars be x km/h and y km/h, respectively.
Their relative speeds when they are moving in same direction = $(x - y)$ km/h.
Their relative speeds when they are in opposite directions = $(x + y)$ km/h.
Now, $\frac{70}{x - y} = 1$ or $x + y = 70$ (i)
and $\frac{70}{(x + y)} = 7$ or $x - y = 10$ (ii)
Solving (i) and (ii), we have
 $x = 40$ km/h and $y = 30$ km/h.
38. (b) $3x + 7 = 7x + 5 \Rightarrow 7x - 3x = 2 \Rightarrow 4x = 2$
 $\Rightarrow x = \frac{1}{2}$
Now, $3x + 7 = x^2 + P$
 $\Rightarrow \frac{3}{2} + 7 = \frac{1}{4} + P$
 $\Rightarrow P = \frac{17}{2} - \frac{1}{4} = \frac{33}{4} = 8\frac{1}{4}$
39. (b) $x^2 - 3x + 1 = 0$
 $\Rightarrow x^2 + 1 = 3x \Rightarrow x + \frac{1}{x} = 3$

$$\therefore x^3 + \frac{1}{x^3} = \left(x + \frac{1}{x}\right)^3 - 3x \cdot \frac{1}{x} \left(x + \frac{1}{x}\right)$$

$$= 27 - 3 \times 3 = 18$$

40. (d) Given, $x \sin^3 \theta + y \cos^3 \theta = \sin \theta \cos \theta$... (i)
and $x \sin \theta - y \cos \theta = 0$... (ii)

From Eq. (ii),
 $x \sin \theta = y \cos \theta$
From Eq. (i)
 $y \cos \theta \cdot \sin^2 \theta + y \cos^3 \theta = \sin \theta \cos \theta$
 $y \cos \theta (\sin^2 \theta + \cos^2 \theta) = \sin \theta \cos \theta$
 $y = \sin \theta$

From Eq. (i)
 $x = \cos \theta$
 $\therefore x^2 + y^2 = \sin^2 \theta + \cos^2 \theta = 1$

41. (d) A palace is the official home of a King.
Similarly,
An igloo is a small round house of an Eskimo.

42. (c) $A \xrightarrow{5} F \xrightarrow{5} K \xrightarrow{5} P$
 $D \xrightarrow{5} I \xrightarrow{5} N \xrightarrow{5} S$
 $W \xrightarrow{5} B \xrightarrow{5} G \xrightarrow{5} L$
 $O \xrightarrow{5} T \xrightarrow{5} Y \xrightarrow{5} D$

43. (d) $12 : 20 :: \boxed{30} : \boxed{42}$
 $(3 \times 4) \quad (4 \times 5) \quad (5 \times 6) \quad (6 \times 7)$

44. (a) All others except (a) are prime numbers.
45. (b) Lotus grows in the water but rest grow on the land.

46. (c)
 $B \xrightarrow{+2} D \xrightarrow{+2} F, C \xrightarrow{+3} F \xrightarrow{+3} I, D \xrightarrow{+4} H \xrightarrow{+4} L,$
 $E \xrightarrow{+5} J \xrightarrow{+5} O$

47. (b) Each of the numbers is doubled and 1, 2, 3, 4, 5, 6 is added in turn, so $89 \times 2 + 6 = 184$.

48. (a)

1	2	3	4
DEPU	TA	TI	ON

Coded \longrightarrow

ON	TA	DEPU	TI
4	2	1	3

- Similarly,

1	2	3	4
DERI	VA	TI	ON

Coded \longrightarrow

ON	VA	DERI	TI
4	2	1	3

49. (b) $5 \quad 1 \quad 3 \quad 2 \quad 4$
Force \rightarrow Forecast \rightarrow Foreign \rightarrow Forget \rightarrow Forsook

50. (a) The sequence is : abcd d abcd d abcd d abc.
51. (d) Clearly, number of students in the class
 $= (6 + 1 + 25) = 32$

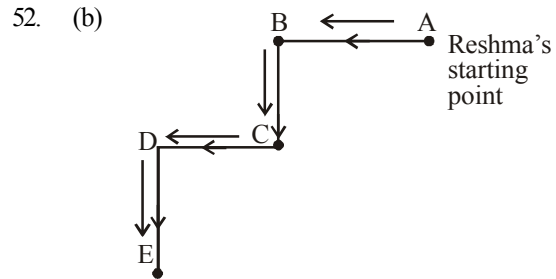

- Now, Reshma is going to south direction
53. (b) Seema > Sohan > Seeta ... (i)
Deepti > Sweta > Seema ... (ii)
Combining (i) and (ii) we get
Deepti > Sweta > Seema > Sohan > Seeta
54. (b) 3 represents the area common to all types.
55. (b) $24 \div 6 \times 4 + 9 - 8$
 $4 \times 4 + 9 - 8$
 $16 + 9 - 8$
 $25 - 8 = 17$

56. (b) Mani's Age = 60 years
Prabhu's Age = $60/2 = 30$ years
Romana's Age = $30/2 = 15$ years
57. (d) $14 + 9 = 23$
 $9 \times 5 = 45$
 $23 + 45 = 68$
58. (d) $3 + 4 + 3 = 10$
 $4 + 6 + 4 = 14$
 $8 + 6 + 6 = 20$
 $8 + 3 + 8 = 19$

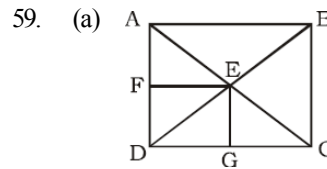

These are twelve triangles in the above figure - ABE, AFE, DFE, DGE, GCE, CBE, ABC, DBC, DAB, ADC, AED and CED

60. (c) According to the dice I and III

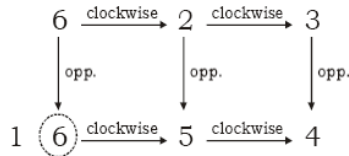

61. (b)

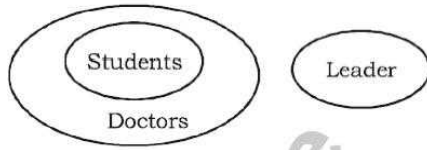

Conclusion- I. \times
 II. \checkmark

62. (c) 63. (c)

64. (a)

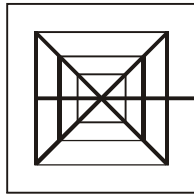

65. (c) $\begin{matrix} F & A & I & T & H \\ \downarrow & \downarrow & \downarrow & \downarrow & \downarrow \\ 31 & 34 & 23 & 76 & 79 \end{matrix}$

66. (d) As $\begin{matrix} L \rightarrow 8 & \text{and} & H \rightarrow 7 \\ A \rightarrow \& & I \rightarrow * \\ T \rightarrow 4 & & R \rightarrow 3 \\ E \rightarrow \$ & & E \rightarrow \$ \end{matrix}$

Similarly,

$\begin{matrix} H \rightarrow 7 \\ A \rightarrow \& \\ I \rightarrow * \\ L \rightarrow 8 \end{matrix}$

67. (b) Others related to 'parts of tree'.

68. (d) Since 'Potato' is called Banana. Thus, 'Banana' grows underground.

69. (d) EI, EG, GI and NL.

70. (a) $P + S \rightarrow P$ is daughter of S.
 $S - T \rightarrow S$ is father of T.
 Therefore, P is sister of T.

71. (d) $P \times Q \rightarrow P$ is wife of Q.
 $Q - T \rightarrow Q$ is father of T.
 T is child of P and Q.
 The gender of T is not known.
 T is either son or daughter of P.

72. (d) $P \times S \rightarrow P$ is wife of S.
 $S \div T \rightarrow S$ is son of T.
 T is either father-in-law or mother-in-law of P.
 $P \div S \rightarrow P$ is son of S.
 $S \times T \rightarrow S$ is daughter of T.
 Therefore, T is father of P.
 $P - S \rightarrow P$ is father of T.
 $P + T \rightarrow P$ is daughter of T.
 $T \div S \rightarrow T$ is son of S.
 Therefore, T is father of P.

73. (a) 74. (b) 75. (c) 76. (c)

77. (b) 78. (a) 79. (d) 80. (c)

81. (b) The Theosophical Society was formed by Helena Petrovna Blavatsky, Henry Steel Olcott, William Quan Judge and others in November 1875 in New York. The aim of the society was to promote spiritual principles and search for truth known as Theosophy.

82. (c) Chlorofluoro carbon (CF_2Cl_2) is also known as freon. It is used as refrigerants in refrigerators and air conditions. It is also used as propellant in aerosols and foams.

83. (c) The amount of water vapour in the air at any given time is usually less than that required to saturate the air. The relative humidity is the percent of saturation humidity, generally calculated in relation to saturated vapour density.

$$\text{Relative Humidity} = \frac{\text{actual vapor density}}{\text{saturation vapor density}} \times 100\%$$

84. (a) The country's first railway, built by the Great Indian Peninsula Railway (GIPR), opened in 1853 between Bombay and Thane.

85. (d) Tansen, who was one of the nine jewels or navaratnas in the court of Emperor Akbar, was born in a Hindu family at Behat near Gwalior in the Madhya Pradesh state. Father of Tansen was Makarand Pande, who named him Ramtanu Pandey.

86. (d) Cyclical unemployment is unemployment that results when the overall demand for goods and services in an economy cannot support full employment. It occurs during periods of slow economic growth or during periods of economic contraction.

87. (b) According to Article 243 (1) the governor of the state shall set up the Finance Commission within the period of one year. State Finance Commissions receive grants from the Finance Commission that is set up by the central government.
88. (c) Muhammad Ali Jinnah drafted the constitution of Muslim league 'The green Book'.
89. (a) Bluetooth technology allows wireless communications between equipments.
90. (c) The Arthashastra is a treatise on Political philosophy. The book, written in Sanskrit, discusses theories and principles of governing a state. The meaning of Arthashastras is 'Science of Polity'. It is written by Kautilya.
91. (c) Lord Dufferin was the Viceroy of India at the time of the formation of Indian National Congress.
92. (c) Diamond occurs in its purest form of carbon black in nature.
93. (b) Shankaracharya philosophy is called Advaita. The Advaita Vedanta focuses on the basic concepts as Brahman, atman, vidya (knowledge), avidya (ignorance), maya, karma and moksha.
94. (d) Special Drawing Rights (SDRs) are an international type of monetary reserve currency, created by the International Monetary Fund (IMF) in 1969, which operate as a supplement to the existing reserves of member countries.
95. (b) Inferior goods have a negative (less than 0) income elasticity of demand meaning that demand falls as income rises.
96. (c) 7th Schedule gives allocation of powers and functions between Union & States. It contains 3 lists:
Union List (97 Subjects)
States List (66 Subjects)
Concurrent List(52 Subjects)
97. (b) Details of Citizenship are mentioned in part II(Article 5-11) of the constitution.
98. (c) The origins of the game in Manipur are traced to early precursors of Sagol Kangjei. This was one of three forms of hockey in Manipur, the other ones being field hockey (called Khong Kangjei) and wrestling-hockey (called Mukna Kangjei). In Manipur, polo is traditionally played with seven players to a side.
99. (c) This is the autobiography of Naseeruddin Shah.
100. (c) Influenza is caused by virus and all other three diseases are bacterial, Influenza, generally called flu, is an infectious disease caused by RNA viruses of family Orthomyxoviridae.
101. (b) 102. (d) 103. (a) 104. (a)
105. (d) 106. (b) 107. (b) 108. (d)
109. (b) 110. (c) 111. (b) 112. (b)
113. (c) 114. (a) 115. (b)
116. (a) The Surrogacy (Regulation) Bill, 2016 was introduced by Health Minister JP Nadda in the Lok Sabha on November 21, 2016 to ban commercial surrogacy, aimed to protect women from exploitation and ensure the rights of the child born through surrogacy.
117. (b) Uttar Pradesh Chief Minister Akhilesh Yadav on November 21, 2016, inaugurated the six-lane Greenfield Agra-Lucknow Expressway at Bangarmau in Unnao district of Uttar Pradesh in presence of Samajwadi Party chief Mulayam Singh Yadav.
118. (a) National Geographic Traveler magazine announced its annual Best of the World list in 3 categories such as Cities, Nature, or Culture. India has been named under the category of nature in the list.
119. (c) Google with the help of its cultural arm Google Arts & Culture launched a virtual artwork and exhibition on November 19, 2016, 'Women in India: Unheard Stories', a special project consisting of about 50 artworks and virtual exhibitions on the life of Indian women in history from past 2,500 years and from 26 cultural institutions across the country with more than 1,800 artworks, showcasing the achievements of the Indian women in the country.
120. (d) The Indore-Patna Express train derailed in Kanpur Dehat district of Uttar Pradesh early morning about 3.10am on November 21, 2016 with nearly 133 people killed and more than 200 injured when 14 coaches of the express train derailed near Pukhrayan, about 100 km from Kanpur.

ARITHMETIC

- How many numbers, between 1 and 300 are divisible by 3 and 5 together?
(a) 16 (b) 18
(c) 20 (d) 100
- The value of $3 \div \left[(8-5) \div \left\{ (4-2) \left(2 \frac{8}{13} \right) \right\} \right]$ is
(a) $\frac{15}{17}$ (b) $\frac{13}{17}$
(c) $\frac{15}{19}$ (d) $\frac{13}{19}$
- Kamya purchased an item for ₹46,000 and sold it at a loss of 12 per cent. With that amount she purchased another item and sold it at a gain of 12 per cent. What was her overall gain/loss?
(a) Loss of ₹662.40 (b) Profit of ₹662.40
(c) Loss of ₹642.80 (d) Profit of ₹642.80
- The call rate of a SIM of company A is one paisa for every three seconds. Another SIM of company B charges 45 paise per minute. A man talked for 591 seconds from the SIM of company A and 780 seconds from the SIM of company (b) What would be the total amount he spent?
(a) ₹7.80 (b) ₹7.40
(c) ₹7.46 (d) ₹7.82
- An amount of money is to be divided among P, Q and R in the ratio of 3 : 5 : 7 respectively. If the amount received by R is ₹4,000 more than the amount received by O, what will be the total amount received by P and Q together?
(a) ₹8,000
(b) ₹12,000
(c) ₹16,000
(d) Cannot be determined
- A 180-metre long train crosses another 270-metre long train running in the opposite direction in 10.8 seconds. If the speed of the first train is 60 kmph, what is the speed of the second train in kmph?
(a) 80
(b) 90
(c) 150
(d) Cannot be determined
- In what time will ₹300000 amount to ₹746496 at 20% compound interest?
(a) 3 yrs (b) 4 yrs
(c) 5 yrs (d) 6 yrs
- Two person Ravi and Shyam can do a work in 60 days and 40 days respectively. They began the work together but Ravi left after some time and Shyam finished the remaining work in 10 days. After how many days did Ravi leave?
(a) 8 days (b) 12 days
(c) 15 days (d) 18 days
- What is the number whose 20% is 30% of 40?
(a) 90 (b) 80
(c) 60 (d) 50
- The largest and the second largest angles of a triangle are in the ratio of 4 : 3. The smallest angle is half the largest angle. What is the difference between the smallest and the largest angles of the triangle?
(a) 30° (b) 60°
(c) 40° (d) 20°
- If A is the area of a right angled triangle and b is one of the sides containing the right angle, then what is the length of the altitude on the hypotenuse?
(a) $\frac{2Ab}{\sqrt{b^4} \ 4A^2}$ (b) $\frac{2A^2b}{\sqrt{b^4} \ 4A^2}$
(c) $\frac{2Ab^2}{\sqrt{b^4} \ 4A^2}$ (d) $\frac{2A^2b^2}{\sqrt{b^4} \ A^2}$
- Bisectors of two adjacent angles A and B of a quadrilateral $ABCD$ intersect each other at a point P . Which one of the following is correct ?
(a) $2\angle APB = \angle C + \angle D$
(b) $\angle APB = \angle C + \angle D$
(c) $\angle APB = 180^\circ - (\angle C + \angle B)$
(d) $\angle APB = 180^\circ - (\angle C + \angle D)$

13. If $\frac{3}{x+y} + \frac{2}{x-y} = 2$ and $\frac{9}{x+y} - \frac{4}{x-y} = 1$,

then what is the value of $\frac{x}{y}$?

- (a) $\frac{3}{2}$ (b) 5
(c) $\frac{2}{3}$ (d) $\frac{1}{5}$

14. The mean of 100 values is 45. If 15 is added to each of the first forty values and 5 is subtracted from each of the remaining sixty values, the new mean becomes

- (a) 45 (b) 48
(c) 51 (d) 55

15. The sum of the square of a number and the square of the reciprocal of the number, is thrice the difference of the square of the number and the square of the reciprocal of the number. What is the number?

- (a) 1 (b) $2^{1/4}$
(c) $3^{1/3}$ (d) $4^{1/4}$

16.

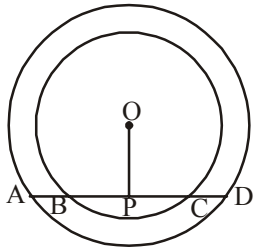

In the figure given above, AD is a straight line, OP perpendicular to AD and O is the centre of both circles. If $OA = 20$ cm, $OB = 15$ cm and $OP = 12$ cm, then what is AB equal to?

- (a) 7 cm (b) 8 cm
(c) 10 cm (d) 12 cm

17. Which one of the following is correct?

- (a) $-\frac{7}{10} < -\frac{2}{3} < -\frac{5}{8}$
(b) $-\frac{5}{8} < -\frac{2}{3} < -\frac{7}{10}$
(c) $-\frac{5}{8} < -\frac{7}{10} < -\frac{2}{3}$
(d) $-\frac{7}{10} < -\frac{5}{8} < -\frac{2}{3}$

18. If $\tan \theta = 1$, then find the value of

$$\frac{8 \sin \theta + 5 \sin \theta}{\sin^3 \theta - 2 \cos^3 \theta + 7 \cos \theta}$$

- (a) 2 (b) $2\frac{1}{2}$
(c) 3 (d) $\frac{4}{5}$

19. If θ be a positive acute angle satisfying $\cos^2 \theta + \cos^4 \theta = 1$, then the value of $\tan^2 \theta + \tan^4 \theta$ is

- (a) $\frac{3}{2}$ (b) 1
(c) $\frac{1}{2}$ (d) 0

20. If $\tan 15^\circ = 2 - \sqrt{3}$, the value of $\tan 15^\circ \cdot \cot 75^\circ + \tan 75^\circ \cdot \cot 15^\circ$ is.

- (a) 14 (b) 12
(c) 10 (d) 8

DIRECTIONS (Q. 21-23): Study the following table carefully and answer the questions given below.

Percentage distribution of students in various disciplines in five different colleges

Discipline → Colleges ↓	Arts	Commerce	Science	Total number of students
A	25	35	40	17500
B	15	45	40	25000
C	15	30	55	35300
D	28	48	24	23000
E	29	30	41	32400

21. What is the average number of students from the discipline of Commerce from all the colleges together?

- (a) 9745 (b) 9735
(c) 9720 (d) 9750

22. Which college has the least number of students from the discipline of Science?

- (a) A (b) C
(c) E (d) D

23. What is the difference between the total number of students from the discipline of Arts from all the colleges together and the total number of students from the discipline of Science from all the colleges together?

- (a) 22874 (b) 23863
(c) 22963 (d) 25963

24. If the number of square centimetres on the surface area of a sphere is three times the number of cubic centimetres in its volume, then what is its diameter?
 (a) 1 cm (b) 2 cm
 (c) 3 cm (d) 6 cm
25. For a plot of land of $100\text{ m} \times 80\text{ m}$, the length to be raised by spreading the earth from stack of a rectangular base $10\text{ m} \times 8\text{ m}$ and vertical section being a trapezium of height 2 m. The top of the stack is $8\text{ m} \times 5\text{ m}$. How many centimeters can the level raised?
 (a) 3 cm (b) 2.5 m
 (c) 2 cm (d) 1.5 cm
26. If 17^{200} is divided by 18, the remainder is :
 (a) 17 (b) 16
 (c) 1 (d) 2
27. $\sqrt{86.49} \sqrt{5} (?)^2 = 12.3$.
 (a) -2 (b) 2
 (c) $\sqrt{14}$ (d) $\sqrt{2}$
28. Find the greatest number of six digits which, number being divided by 6, 8, 9 and 10, leaves 4, 5, 6, 7 and 8 as remainder respectively.
 (a) 997918 (b) 997919
 (c) 997914 (d) 997916
29. The total of the ages of a class of 75 girls is 1050, the average age of 25 of them is 12 yrs and that of another 25 is 16 yr. Find the average age of the remaining girls.
 (a) 12 yrs (b) 13 yrs
 (c) 14 yrs (d) 15 yrs
30. A dealer sold a mixer for ₹ 420 at a loss of 12.5%. At what price should he have sold it to gain 12.5%.
 (a) ₹ 620 (b) ₹ 540
 (c) ₹ 650 (d) ₹ 750
31. A and B rent a pasture for 10 months. A puts in 100 cows for 8 months. How many cows can B put in for the remaining 2 months, if he pays half as much as A?
 (a) 300 (b) 600
 (c) 800 (d) 1000
32. A and B can finish a work in 10 days while B and C can do it in 18 days. A started the work, worked for 5 days, then B worked for 10 days and the remaining work was finished by C in 15 days. In how many days could C alone have finished the whole work ?
 (a) 30 days (b) 15 days
 (c) 45 days (d) 24 days
33. A man walks half of the journey at 4 km/h by cycle does one third of journey at 12 km/h and rides the remainder journey in a horse cart at 9 km/h, thus completing the whole journey in 6 hours and 12 minutes. The length of the journey is
 (a) 36 km (b) $\frac{1332}{67}$ km
 (c) 40 km (d) 28 km
34. The ratio between the length and the breadth of a rectangular park is 3 : 2. If a man cycling along the boundary of the park at the speed of 12 km / hr completes one round in 8 minutes, then the area of the park (in sq. m) is:
 (a) 15360 (b) 153600
 (c) 30720 (d) 307200
35. John sold a fan at a loss of 7%. If he had sold it for Rs 48 more, he would have gained 5%. Find the cost price of the fan.
 (a) ₹ 350 (b) ₹ 480
 (c) ₹ 240 (d) ₹ 400
36. Pipes A and B can fill a tank in 5 and 6 hours respectively. Pipe C can empty it in 12 hours. If all the three pipes are opened together, then the tank will be filled in :
 (a) $1\frac{13}{17}$ hours (b) $2\frac{8}{11}$ hours
 (c) $3\frac{9}{17}$ hours (d) $4\frac{1}{2}$ hours
37. The jogging track in a sports complex is 726 metres in circumference. Pradeep and his wife start from the same point and walk in opposite directions at 4.5 km/h and 3.75 km/h, respectively. They will meet for the first time in :
 (a) 5.5 min (b) 6.0 min
 (c) 5.28 min (d) 4.9 min
38. If $\frac{2a}{a} \frac{b}{4b} = 3$, then find the value of $\frac{a}{a} \frac{b}{2b}$?
 (a) $\frac{2}{7}$ (b) $\frac{5}{9}$
 (c) $\frac{10}{7}$ (d) $\frac{10}{9}$

39. If $x - \frac{1}{x} = 5$, then $x^2 + \frac{1}{x^2}$ is:
- (a) 5 (b) 25
(c) 27 (d) 23
40. If $P \sin \theta = \sqrt{3}$ and $P \cos \theta = 1$, then the value of P is
- (a) $\frac{2}{\sqrt{3}}$ (b) $\frac{-1}{\sqrt{3}}$
(c) 2 (d) $\frac{1}{2}$

GENERAL INTELLIGENCE & REASONING

DIRECTIONS (Qs. 41-42) : In questions, select the related word letters numbers from the given alternatives.

41. PETAL : FLOWER
- (a) salt : pepper (b) tire : bicycle
(c) base : ball (d) sandals : shoes
42. 8 : 28 :: 27 : ?
- (a) 28 (b) 8
(c) 64 (d) 65

DIRECTIONS (Qs. 43-44) : In questions, find the odd word/letters/numbers from the given alternatives.

43. (a) FIK (b) DGI
(c) MPR (d) KND
44. (a) Google (b) Firefox
(c) Internet Explorer (d) Chrome

DIRECTIONS (Qs. 45-46) : Complete the given series.

45. LXF, MTJ, NPN, OLR, ?
- (a) PHV (b) PIU
(c) PKX (d) PJW
46. 5, 16, 51, 158, ?
- (a) 1452 (b) 483
(c) 481 (d) 1454
47. Which one set of letters when sequentially placed at the gaps in the given letter series shall complete it ?
- a _bbc_ aab _cca_ bbcc
- (a) bacb (b) acba
(c) caba (d) abba

48. In the following question, a group of letters is given which are numbered 1, 2, 3, 4, 5 and 6. Below are given four alternatives containing combinations of these numbers. Select that combination of numbers so that letters arranged accordingly, form a meaningful word

C E L S M U

1 2 3 4 5 6

- (a) 4, 6, 3, 5, 2, 1 (b) 5, 6, 4, 1, 3, 2
(c) 4, 6, 5, 2, 3, 1 (d) 5, 2, 3, 1, 6, 4
49. If in a code language, COULD is written as BNTKC and MARGIN is written as LZQFHM, how will MOULDING be written in that code ?
- (a) CHMFINTK (b) LNKTCMHF
(c) LNTKCHMF (d) NITKHCMF
50. If FRIEND is coded as HUMJTK, how is CANDLE written in that code ?
- (a) EDRIRL (b) DCQHQK
(c) ESJFME (d) FYOBOC
51. From the given alternatives select the word which cannot be formed using the letters of the given word :
- INFLATIONARY
- (a) FLAIR (b) FAULTY
(c) NATIONAL (d) RATION
52. Rahim and his uncle differ in their ages by 30 years. After 7 years, if the sum of their ages is 66, what will be the age of the uncle ?
- (a) 39 (b) 41 (c) 51 (d) 49
53. A cyclist goes 30 km to North and then turning East he goes 40 km. Again he turns to his right and goes 20 km. After this, he turns to his right and goes 40 km. How far is he from his starting point ?
- (a) 25km (b) 40km (c) 6km (d) 10km
54. If the positions of the first and the sixth digits of the group of digits 5904627813 are interchanged, similarly, the positions of the second and the seventh are interchanged, and so on, which of the following will be the fourth from the right end after the rearrangement?
- (a) 4 (b) 9 (c) 1 (d) 0
55. Arrange the words given below in a meaningful order.
1. Protect 2. Pressure
3. Relief 4. Rain
5. Flood
- (a) 2, 4, 3, 1, 5 (b) 2, 5, 4, 1, 3
(c) 2, 4, 5, 1, 3 (d) 3, 2, 4, 5, 1

56. A man said to lady, "Your mother's husband's sister is my aunt." How is the lady related to the man?
 (a) Daughter (b) Grand daughter
 (c) Mother (d) Sister

DIRECTION: In question no. 57 one statement is given followed by some conclusions. You have to consider the statements to be true even if they seems to be at variance from commonly known facts. You are to decide which of the given conclusion, if any, follow from the given statements.

57. Statements :
 Students are influenced more by their teachers.
 Conclusions :
 I. Students consider their teachers as their role models.
 II. Much time of students is spent at school.
 (a) Only conclusion I follows
 (b) Only conclusion II follows
 (c) Both conclusions I and II follows
 (d) Neither conclusion I nor II follows

58. How many rectangles are there in the question figure?

Question figure :

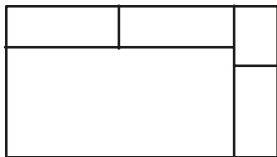

- (a) 6 (b) 7
 (c) 8 (d) 9

59. Find out the two signs to be interchanged for making following equation correct.

$$5 + 3 \times 8 - 12 \div 4 = 3$$

- (a) + and - (b) - and ÷
 (c) + and × (d) + and ÷

DIRECTIONS (Qs. 60-61) : In questions below, select the missing number from the given responses.

60.

7	9	8
2	4	3
5	7	6
16	32	?

- (a) 17 (b) 23
 (c) 47 (d) 73

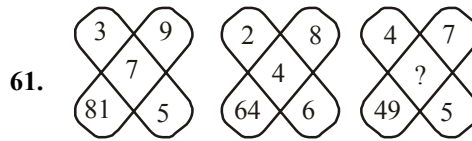

- (a) 1 (b) 8
 (c) 6 (d) 16

62. A piece of paper is folded and cut as shown below in the question figures. From the given answer figures, indicate how it will appear when opened.

Question figures :

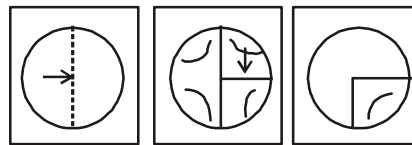

Answer figures :

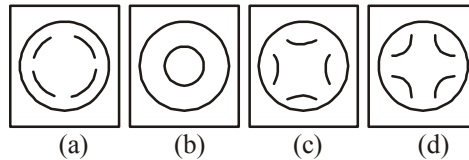

63. Complete the given figure.

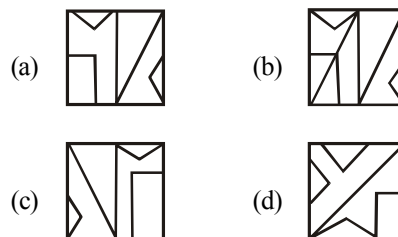
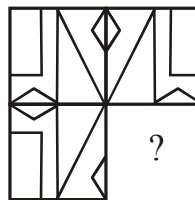

DIRECTION (Q. 64) : In the following question, choose the correct mirror-image of the Fig. (X) from amongst the four alternatives (a), (b), (c) and (d) given along with it.

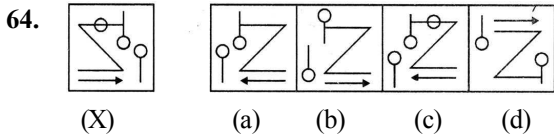

65. Select from the alternative, the box that can be formed by folding the sheet shown in figure (X) :

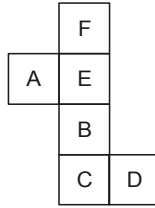

(X)

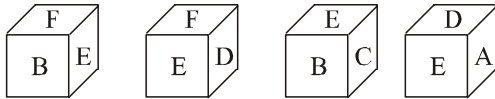

(A) (B) (C) (D)

- (a) A only (b) B only
(c) A and C only (d) A, B, C and D

66. Veena walked 5m towards north, took a left turn and walked 7 m. She took a left turn again and walked 8m before taking a left turn and walking 7 m. She then took a final left turn and walked 1 m before stopping. How far is Veena from the starting point ?

- (a) 3m (b) 6m
(c) 4m (d) 2m

67. In a certain code IDEAS is written as HEDBR and WOULD is written as VPTM(c) How will RIGHT be written in the same code ?

- (a) QJHIS (b) QJFGS
(c) SHHGU (d) QJFIS

DIRECTIONS (Qs. 68-70): Study the given information carefully and answer the given questions.

Eight people - J, K, L, M, N, O, P and Q are sitting around a circular table facing the centre, not necessarily in the same order. O is sitting third to the right of M. There is only one person sitting between M and J. There are only three people between J and K. P is an immediate neighbour of J. There are only three people between P and L. N is second to the right of P.

68. Which of the following is **true** regarding the given arrangement?

- (a) M is an immediate neighbour of K
(b) N is an immediate neighbour of J
(c) P is second to the left of O
(d) There are four people between N and O.

69. Who is sitting second to the left of the one who is sitting second to the left of Q?

- (a) M (b) K
(c) N (d) L

70. 'Four of the following five are alike in a certain way based on their seating positions in the above arrangement and so form a group. Which one does **not** belong to the group?

- (a) PQ (b) KL
(c) MN (d) KO

DIRECTIONS (Qs. 71-73) : Study the following arrangement carefully and answer the questions given below :

B U B D C E D B D E U B A D C B E
A C D A E B A U A C D B C A C

71. How many such pairs of alphabets are there in the series of alphabets given in BOLD (A to E) in the above arrangement each of which has as many letters between them (in both forward and backward directions) as they have between them in the English alphabetical series ?

- (a) None (b) One
(c) Two (d) More than three

72. Which of the following is the eighth to the left of the twentieth from the left end of the above arrangement ?

- (a) C (b) E
(c) U (d) B

73. How many meaningful words can be formed with the alphabets which are first, second, fifth and sixth from the left end of the above arrangement ?

- (a) None (b) One
(c) Two (d) Three

74. In a certain code GRANT is written as UOBESH and PRIDE is written as FEJSQ, How is SOLD written in that code?

- (a) EPMT (b) TPME
(c) EMPT (d) CKNR

75. Four of the following five are alike in a certain way and so form a group. Which is the one that does not belong to that group?
 (a) 19 (b) 17
 (c) 13 (d) 27
76. How many meaningful English words can be made with the second, the fourth, the sixth and the seventh letters of the word STUMBLE using each letter only once in each word?
 (a) None (b) One
 (c) Two (d) Three
77. What should come in place of the question mark (?) in the following letter series based on the English alphabetical order?
 BE GJ LO QT ?
 (a) UX (b) VY
 (c) SV (d) RU
78. How many such pairs of letters are there in the word GOVERNMENT each of which has as many letters between them in the word (in both forward and backward directions) as in the English alphabet?
 (a) None (b) One
 (c) Two (d) More than three
79. Four of the following five are alike in a certain way and hence form a group. Which of the following **does not** belong to that group ?
 (a) Walk (b) Cry
 (c) Play (d) Alive
80. How many such pairs of letters are there in the word 'VIRTUAL', each of which has as many letters between them in the word (in both forward and backward direction) as they have between them in the English alphabetical series ?
 (a) None (b) One
 (c) Two (d) Three
83. Which of the following is not an algae?
 (a) Blue Algae (b) Green Algae
 (c) Red Algae (d) Brown Algae
84. 'Defence Expenditure' forms part of which of the component of Union Budget?
 (a) Plan Revenue Expenditure
 (b) Non-Plan Revenue Expenditure
 (c) Plan Capital Expenditure
 (d) None of these
85. Any session of State Legislature is prorogated by –
 (a) Presiding officer of the house
 (b) The Chief Minister of the State
 (c) The Governor
 (d) None of the above
86. The 'official reserve transactions' are seen as which items in Balance of Payment?
 (a) Autonomous (b) Accommodating
 (c) Above the line (d) None of these
87. Where "Hathigumpha" inscription of Kharwel is located?
 (a) Uttar Pradesh (b) Bihar
 (c) Bengal (d) Odisha
88. The right to 'equality before the law' contained in Article 14 of the Constitution of India is available to —
 (a) natural persons only
 (b) legal persons only
 (c) citizens of India
 (d) all persons whether natural or legal
89. The purpose of an Adjournment Motion is to —
 (a) Propose a reduction in the budget
 (b) Seek the approval of the House on a proposal
 (c) Draw the attention of the House to a matter of urgent public importance
 (d) Seek the permission of the House to introduce a Government Bill

GENERAL AWARENESS

81. The Four Varnas are described in which Mandal of Rigveda?
 (a) First Mandal (b) Third Mandal
 (c) Tenth Mandal (d) Ninth Mandal
82. The Chief of State Election Commission is appointed by –
 (a) The President
 (b) The Governor
 (c) The committee of elected members of State Legislative Assembly
 (d) Election Commission of India
90. The book 'The man who Divided India' was written by —
 (a) Maulana Abul Kalam Azad
 (b) Dr. Rajendra Prasad
 (c) Rafiq Zakaria
 (d) None of these
91. The capital of Emperor Kanishka was situated in which city of modern Pakistan?
 (a) Lahore (b) Karachi
 (c) Peshawar (d) Rawalpindi

92. Name the Viceroy who was killed in Andaman & Nicobar Island?
 (a) Lord Mayo (b) Lord Elgin
 (c) Lord Hastings (d) Lord Dalhousie
93. What is erythroblastosis fetalis?
 (a) It is Haemolytic disease of the fetus and newborn.
 (b) It is a type of Leukemia in the new born.
 (c) It happens typically when father is Rh^{-ve} and mother is Rh^{+ve}.
 (d) It is seen only in human beings.
94. 'Effective Revenue Deficit' refers to –
 (a) Revenue Deficit-Grants from Centre to State for capital asset generation
 (b) Revenue Deficit-Expenditure on capital generation from the Centres grant to State
 (c) Revenue Deficit-Net interest liability
 (d) Fiscal Deficit-Grants to state for capital asset generation
95. 'Red Ink' is prepared from –
 (a) Phenol (b) Aniline
 (c) Congo red (d) Eosin
96. When did India become a member of the International Monetary Fund?
 (a) 1952 (b) 1950
 (c) 1947 (d) 1945
97. Which one is not micro nutrient?
 (a) Iron (b) Zinc
 (c) Sulphur (d) Manganese
98. An air bubble inside water behave as an:
 (a) bifocal lens / (b) convergent lens /
 (c) divergent lens / (d) cylindrical lens
99. ICAO stands for
 (a) International Civil Aviation Organization
 (b) Indian Corporation of Agriculture Organization
 (c) Institute of Company of Accounts Organization
 (d) None of the above
100. At which of the following places is the College of Defence Management located?
 (a) Dehradun (b) Pune
 (c) Secunderabad (d) Chennai
101. "Hopman cup" is related to which sports?
 (a) Football (b) Lawn Tennis
 (c) Badminton (d) Cricket
102. Which of the following memories is an optical memory?
 (a) Floppy Disk (b) Bubble Memories
 (c) CD-ROM (d) Core Memories
103. Which among the following blood protein regulates the amount of water in plasma?
 (a) Globulin (b) Albumin
 (c) Fibrin (d) Fibulin
104. Who headed the 7th Pay Commission whose recommendations were approved by the Union Cabinet?
 (a) Vivek Rae (b) Ratin Roy
 (c) Meena Agarwal (d) AK Mathur
105. This Central Asian city hosted the 2016 Shanghai Cooperation Organisation Summit.
 (a) Tashkent (b) Astana
 (c) Bishkek (d) Dushanbe
106. Which of these keys is not on the number keypad?
 (a) Ctrl (b) Delete
 (c) Enter (d) Num Lock
107. A program that converts a high-level language source file into a machine-language file is called a
 (a) translator (b) assembler
 (c) compiler (d) linker
108. A CD - ROM disk
 (a) cannot be erased and rewritten
 (b) has more storage capacity than a CD-R
 (c) holds less data than a floppy disk
 (d) can be written to only once
109. The smallest unit of information, a computer can understand and process is known as a
 (a) digit (b) kilobyte
 (c) bit (d) byte
110. For creating a document, you use command at File Menu.
 (a) Open (b) Close
 (c) New (d) Save
111. The famous national song 'Vande Mataram' was written by
 (a) Bankim Chandra Chatterji
 (b) Rabindrantha Tagore
 (c) Kamala Das
 (d) Sarojini Naidu
112. Viruses are made up of
 (a) Protein and lipids
 (b) Nucleic and protein
 (c) Lipids and carbohydrate
 (d) Carbohydrate and Nucleic acid

113. Light year is the unit of
(a) Frequency (b) Distance
(c) Energy (d) Time
114. The first telegraph line between Calcutta and Agra was opened in
(a) 1852 (b) 1853
(c) 1854 (d) 1855
115. Which of the following physical quantities has no dimension?
(a) Force (b) Momentum
(c) Impulse (d) Angle
116. Which state government has launched an emergency police service system in the state for 24 hours public safety?
(a) Madhya Pradesh (b) Rajasthan
(c) Uttar Pradesh (d) Haryana
117. Who has been awarded the 2016 Tata Literature Live! Lifetime Achievement Award?
(a) Anil K Gupta
(b) Amitav Ghosh
(c) Siddhartha Mukherjee
(d) Srinath Raghavan
118. Which player bagged the super series title in the china open badminton tournament 2016?
(a) PV Sindhu
(b) Parupalli Kashyap
(c) Jwala Gutta
(d) Saina Nehwal
119. Which state has emerged as hub of drug manufacturing?
(a) Jammu & Kashmir (b) Goa
(c) Himachal Pradesh (d) Kerala
120. Who has won Gold Medal in men's Trap event in National Shooting Championship?
(a) Ronjan Sodh
(b) Abhinav Bindra
(c) Rajyavardhan Singh Rathore
(d) Manavjit Singh Sandhu

Hints & Explanations

1. (c) LCM of 3 and 5 = 15
 Number divisible by 15 are 15, 30, 45300.
 Let total numbers are n
 $300 = 15 + (n-1) \times 15$
 $300 = 15 + 15n - 15$
 $\Rightarrow n = 20$
2. (b) $3 \div \left[8 - 5 \div \left\{ (4-2) \div \left(2 \times \frac{8}{13} \right) \right\} \right]$
 $\Rightarrow 3 \div \left[3 \div \left(2 \times \frac{34}{13} \right) \right]$
 $\Rightarrow 3 \div \left[3 \div \left(2 \times \frac{13}{34} \right) \right]$
 $\Rightarrow 3 \div \left[\frac{3 \times 34}{13 \times 2} \right]$
 $\Rightarrow \frac{3 \times 13 \times 2}{3 \times 34} \times \frac{13}{17}$
3. (a) First S.P. = $\frac{46000 \times 88}{100} = ₹ 40480$
 Second S.P. = $\frac{40480 \times 112}{100} = ₹ 45337.6$
 \therefore Loss = $₹(46000 - 45337.6) = ₹ 662.4$
4. (d) Total amount spent
 $= \left(\frac{591}{3} + \frac{45}{60} \times 780 \right)$ paise
 $= (197 + 585)$ paise
 $= 782$ paise = ₹ 7.82
5. (c) (a) amount received by R = ₹ 7x
 (a) amount received by Q = ₹ 5x
 So difference = $7x - 5x$
 $7x - 5x = 4000$
 $\therefore x = 2000$
 (a) amount received by
 P = $2000 \times 3 = ₹ 6000$
 Q = $2000 \times 5 = ₹ 10,000$
 Total amount = $6,000 + 10,000 = 16,000$
6. (b) Relative speed of two trains
 $= \frac{180}{10.8} \frac{270}{s} - \frac{4500}{108} \frac{m}{s}$
7. (c) $300000 \left[1 + \frac{20}{100} \right]^t = 746496$
 $\therefore \left[\frac{6}{5} \right]^t = \frac{746496}{300000} = \frac{7776}{3125} = \left(\frac{6}{5} \right)^5$
 $t = 5$
8. (d) Shyam alone worked for 10 days. So work done by him = $\frac{10}{40} = \frac{1}{4}$
 \therefore (Ravi + Shyam) have done $1 - \frac{1}{4} = \frac{3}{4}$ of the work.
 (Ravi + Shyam) do $\frac{3}{4}$ of the work in $24 \times \frac{3}{4} = 18$ days
9. (c) Let the number be x
 (a) according to question 20% of $x = 30\%$ of 40
 $\Rightarrow \frac{x \times 20}{100} = \frac{40 \times 30}{100}$
 $\Rightarrow x = \frac{40 \times 30}{20} = 60$
10. (c) The smallest angle of the triangle is half of the largest angle.
 \therefore Ratio of the three angle = $4 : 3 : 2$
 $\therefore 4x + 3x + 2x = 180^\circ$
 $\therefore 9x = 180^\circ$
 $\therefore x = 20^\circ$
 \therefore required difference = $4x - 2x = 2x = 2 \times 20^\circ = 40^\circ$
11. (a) Area of $\Delta (a)(b)(c)$, (a)
 $= \frac{1}{2} \times b \times AB$

$$(a)(b) = \frac{2A}{b} \quad \dots (i)$$

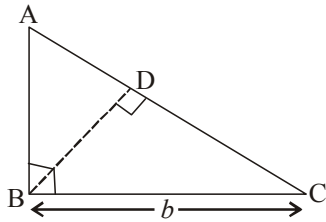

(b) by Phthagoras theorem, $(a)(c)^2 = (a)(b)^2 + (b)(c)^2$

$$(a)(c) = \sqrt{\frac{4A^2}{b^2} + b^2}$$

(a) gain in $\Delta (a)(b)(c)$

$$(a) = \frac{1}{2} \times AC \times BD$$

$$(b)D = \frac{2A}{\sqrt{\frac{4A^2}{b^2} + b^2}} = \frac{2A}{\sqrt{\frac{4A^2 + b^4}{b^2}}} = \frac{2Ab}{\sqrt{4A^2 + b^4}}$$

12. (a) (a) quadrilateral ABCD, AP and BP are bisectors of $\angle(A)$ and $\angle(B)$, respectively.

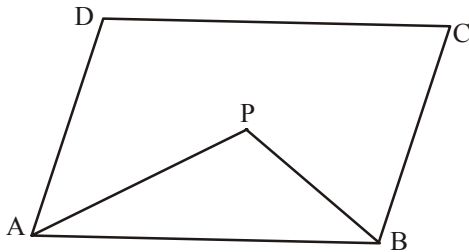

$$\therefore \angle APB = 180^\circ - \left(\frac{1}{2} \angle A + \frac{1}{2} \angle B \right)$$

We know that sum of all angles of a quadrilateral = 360°

$$\Rightarrow \angle(A) + \angle(B) + \angle(C) + \angle(D) = 360^\circ$$

$$\therefore \frac{1}{2} \angle A + \frac{1}{2} \angle B + \frac{1}{2} \angle C + \frac{1}{2} \angle D = \frac{360}{2}$$

$$\Rightarrow \frac{1}{2} \angle C + \frac{1}{2} \angle D = 180 - \left(\frac{1}{2} \angle A + \frac{1}{2} \angle B \right)$$

$$\Rightarrow \frac{1}{2} (\angle C + \angle D) = \angle APB \quad [\text{from eq. (i)}]$$

$$\Rightarrow \angle C + \angle D = 2 \angle APB$$

13. (b) Given,

$$\frac{3}{x+y} + \frac{2}{x-y} = 2 \quad \dots (i)$$

$$\text{and } \frac{9}{x+y} - \frac{4}{x-y} = 1 \quad \dots (ii)$$

$$\text{Let } \frac{1}{x+y} = a \text{ and } \frac{1}{x-y} = b$$

$$\therefore 3a + 2b = 2 \quad \dots (iii)$$

$$9a - 4b = 1 \quad \dots (iv)$$

On multiplying equation (iii) by 2 and addition of equation (iv) and new one, then we get

$$6a + 4b = 4$$

$$\frac{9a - 4b = 1}{15a = 5}$$

$$\Rightarrow a = \frac{5}{15} = \frac{1}{3}$$

$$\therefore \frac{1}{x+y} = \frac{1}{3}$$

$$\Rightarrow x+y=3 \quad \dots (v)$$

On putting the value of (a) in equation (iii), we get

$$3 \times \frac{1}{3} + 2b = 2$$

$$\Rightarrow 2b = 2 - 1 = 1$$

$$\Rightarrow b = \frac{1}{2} \Rightarrow \frac{1}{x-y} = \frac{1}{2}$$

$$\Rightarrow x-y=2 \dots (vi)$$

$$\therefore x+y=3$$

$$\frac{x-y=2}{2x=5}$$

$$\Rightarrow x = \frac{5}{2}$$

From equation (v),

$$y = 3 - \frac{5}{2} = \frac{1}{2}$$

$$\therefore \frac{x}{y} = \frac{\frac{5}{2}}{\frac{1}{2}} = 5$$

14. (b) Given that, mean of 100 values is 45

$$\therefore \text{Sum of 100 values, i.e. } \sum_{i=1}^{100} x = 45 \times 100 = 4500$$

(a) According to condition,

$$\begin{aligned} & \sum_{i=1}^{40} (x_i + 15) + \sum_{i=41}^{100} (x_i - 5) \\ &= \sum_{i=1}^{40} x_i + 15 \times 40 + \sum_{i=41}^{100} x_i - 5 \times 60 \end{aligned}$$

$$= \left(\sum_{i=1}^{40} x_i + \sum_{i=41}^{100} x_i \right) + 600 - 300$$

$$\begin{aligned} &= \sum_{i=1}^{100} x_i + 300 \\ &= 4500 + 300 = 4800 \quad [\text{from equation (i)}] \end{aligned}$$

$$\therefore \text{New mean} = \frac{4800}{100} = 48$$

15. (b) Let number be x , then its reciprocal be $\frac{1}{x}$.

(a) According to question,

$$x^2 - \frac{1}{x^2} = 3 \left(x^2 - \frac{1}{x^2} \right)$$

$$\therefore x^2 - \frac{1}{x^2} = 3x^2 - \frac{3}{x^2} \Rightarrow 2x^2 = \frac{4}{x^2}$$

$$\Rightarrow x^4 = 2 \Rightarrow x = 2^{1/4}$$

16. (a) Given $O(a) = 20$ cm
 $O(b) = 15$ cm and $OP = 12$ cm

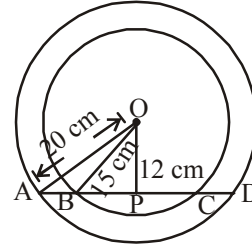

$$(a) P = \sqrt{AO^2 - OP^2}$$

$$= \sqrt{20^2 - 12^2}$$

$$= \sqrt{400 - 144}$$

$$= \sqrt{256} = 16 \text{ cm}$$

$$(b) P = \sqrt{15^2 - 12^2}$$

$$= \sqrt{225 - 144} = \sqrt{81} = 9 \text{ cm}$$

$$\therefore (a)(b) = (a)P - (b)P = 16 - 9 = 7 \text{ cm}$$

17. (a) By option (a),

$$\frac{-7}{10} \quad \frac{-2}{3} \quad \frac{-5}{8}$$

Here LCM of (3, 8, 10) = 120

$$\frac{-7}{10} \times 120 < \frac{-2}{3} \times 120 < \frac{-5}{8} \times 120$$

$$-84 < -80 < -75$$

So this is correct.

18. (a) $\tan \theta = 1$

$$\sec \theta = \sqrt{1 + \tan^2 \theta} = \sqrt{1 + 1} = \sqrt{2}$$

$$\cos \theta = \frac{1}{\sqrt{2}}$$

$$\sin \theta = \sqrt{1 - \cos^2 \theta}$$

$$= \sqrt{1 - \left(\frac{1}{\sqrt{2}} \right)^2} = \frac{1}{\sqrt{2}}$$

$$\text{Now, } \frac{8 \sin \theta + 5 \sin \theta}{\sin^3 \theta - 2 \cos^3 \theta + 7 \cos \theta}$$

$$\begin{aligned}
 &= \frac{8 \times \frac{1}{\sqrt{2}} + 5 \times \frac{1}{\sqrt{2}}}{\left(\frac{1}{\sqrt{2}}\right)^3 - 2 \times \left(\frac{1}{\sqrt{2}}\right)^2 + 7 \times \frac{1}{\sqrt{2}}} \\
 &= \frac{\frac{8}{\sqrt{2}} + \frac{5}{\sqrt{2}}}{\frac{1}{2\sqrt{2}} - \frac{2}{2\sqrt{2}} + \frac{7}{\sqrt{2}}} = \frac{\frac{13}{\sqrt{2}}}{\frac{1-2+14}{2\sqrt{2}}} \\
 &= \frac{13 \times 2}{13} = 2
 \end{aligned}$$

19. (b) Given, $\cos^2 \theta + \cos^4 \theta = 1$
 or, $\cos^4 \theta = 1 - \cos^2 \theta$
 $[\because \sin^2 \theta + \cos^2 \theta = 1]$
 $\cos^4 \theta = \sin^2 \theta$
 or, $1 = \frac{\sin^2 \theta}{\cos^2 \theta} \cdot \frac{1}{\cos^2 \theta}$
 $\Rightarrow \tan^2 \theta \cdot \sec^2 \theta = 1$
 or, $\tan^2 \theta \cdot (1 + \tan^2 \theta) = 1$
 $[\because \sec^2 \theta = 1 + \tan^2 \theta]$

$$\text{or, } \boxed{\tan^2 \theta + \tan^4 \theta = 1}$$

20. (a) $\tan 15^\circ \cdot \cot 75^\circ + \tan 75^\circ \cdot \cot 15^\circ$
 $= \tan 15^\circ \cdot \cot(90^\circ - 15^\circ) + \tan(90^\circ - 15^\circ) \cot 15^\circ$
 $= \tan 15^\circ \cdot \tan 15^\circ + \cot 15^\circ \cdot \cot 15^\circ$
 $= (\tan 15^\circ)^2 + (\cot 15^\circ)^2$

$$= (\tan 15^\circ)^2 + \frac{1}{\tan 15^\circ^2}$$

Putting the value of $\tan 15^\circ = 2 - \sqrt{3}$

$$\begin{aligned}
 &= (2 - \sqrt{3})^2 + \left(\frac{1}{2 - \sqrt{3}}\right)^2 \\
 &= (2 - \sqrt{3})^2 + \left[\frac{1}{2 - \sqrt{3}} \times \frac{2 + \sqrt{3}}{2 + \sqrt{3}}\right]^2 \\
 &= (2 - \sqrt{3})^2 + \left(\frac{2 + \sqrt{3}}{4 - 3}\right)^2 \\
 &= (2 - \sqrt{3})^2 + (2 + \sqrt{3})^2 \\
 &= 2[2^2 + (\sqrt{3})^2]
 \end{aligned}$$

$$\begin{aligned}
 &[\because (a+b)^2 + (a-b)^2 = 2(a^2 + b^2)] \\
 &= 2(4 + 3) = 2 \times 7 = 14
 \end{aligned}$$

21. (a) Required average number of students

$$= \frac{1}{5 \times 100} [35 \times 17500 + 45 \times 25000 + 30 \times$$

$$35300 + 48 \times 23000 + 30 \times 32400]$$

$$= \frac{1}{5} [6125 + 11250 + 10590 + 11040 + 9720]$$

$$= \frac{1}{5} \times 48725 = 9745$$

22. (d) D = 5520
 23. (d) To calculate faster, instead of finding all the students of (arts and Science stream first and then subtracting, let's assume that in each college Science students are more and keep subtracting the number of (arts) students from the number of Science students collegewise.

$$\begin{aligned}
 \text{Difference} &= (40\% \text{ of } 17500 - 25\% \text{ of } 17500) \\
 &+ (40\% \text{ of } 25000 - 15\% \text{ of } 25000) + (55\% \text{ of } 35300 - 15\% \text{ of } 35300) \\
 &+ (24\% \text{ of } 23000 - 28\% \text{ of } 23000) + (41\% \text{ of } 32400 - 29\% \text{ of } 32400) \\
 &= (15 \times 175) + (25 \times 250) + (40 \times 353) + (-4 \times 230) \\
 &+ (12 \times 324) \\
 &= 2625 + 6250 + 14120 - 920 + 3888 \\
 &= 25963
 \end{aligned}$$

24. (b) (a) according to question
 Surface area of sphere = 3 (Volume of sphere)

$$\Rightarrow 4\pi r^2 = 3 \times \frac{4}{3} \pi r^3 \Rightarrow r = 1$$

$$\therefore \text{Diameter} = 2r = 2 \text{ cm}$$

25. (d) The stack is in the form having vertical cross section of trapezium.

\therefore Volume of Earth in the stack = (area of cross section of trapezium \times Height

$$\therefore \text{Volume} = \frac{1}{2} \times (10 + 5) \times 2 \times 8$$

$$= 15 \times 8 \text{ m}^2$$

(a) according to the question,
 Volume of Earth to be spread = (area of field) \times Level raised

$$\therefore \text{Level raised} = \frac{15 \times 8}{100 \times 80} = \frac{15}{1000} \text{ m} = 1.5 \text{ cm}$$

26. (c) $(17)^{200} = (18 - 1)^{200}$

We know that

$$(x + a)^n = x^n + n x^{n-1} a$$

$$\frac{n(n-1)}{1 \times 2} x^{n-2} a^2 + \frac{n(n-1)(n-2)}{1 \times 2 \times 3} x^{n-3} a^3 + \dots + a^n$$

We see that all the terms on the R.H.S. except a^n has x as one of its factor and hence are divisible by x . So, $(x+a)^n$ is divisible by x or not will be decided by a^n .

Let $x = 18$, $a = -1$ and $n = 200$

$\therefore (18-1)^{200}$ is divisible by 18 or not will depend on $(-1)^{200}$ as all other terms in its expansion will be divisible by 18 because each of them will have 18 as one of their factors.

$(-1)^{200} = 1$ ($\because 200$ is even) 1 is not divisible by 18 and is also less than 18.

$\therefore 1$ is the remainder.

27. (b) Let $\sqrt{86.49} \sqrt{5-x^2} = 12.3$.

Then,

$$9.3 \sqrt{5-x^2} = 12.3 \Leftrightarrow \sqrt{5-x^2} = 12.3 - 9.3 = 3$$

$$\Leftrightarrow 5+x^2=9 \Leftrightarrow x^2=9-5=4 \Leftrightarrow x=\sqrt{4}=2.$$

28. (a) The LCM of 6, 7, 8, 9 and 10 = 2520

The greatest number of 6 digits = 999999
Dividing 999999 by 2520, we get 2079 as remainder. Hence, the 6-digit number divisible by 2520, is $(999999 - 2079)$, or 997920.

Since $6-4=2$, $7-5=2$, $8-6=2$, $9-7=2$, $10-8=2$, the remainder in each case is less than the divisor by 2.

\therefore the required number = $997920 - 2 = 997918$

29. (c) Average age of the remaining girls.

$$= \frac{1050 - 25 \times 12 + 25 \times 16}{25}$$

$$= \frac{1050 - 300 + 400}{25}$$

$$= \frac{1050 - 700}{25} = 14 \text{ years}$$

30. (b) $(100 - \text{loss}) : S_1 :: (100 + \text{gain}) : S_2$
 $\therefore (100 - 12.5) : 420 :: (100 + 12.5) : S_2$

$$87.5 : 420 :: 112.5 : S_2$$

$$\Rightarrow 87.5 \times S_2 = 420 \times 112.5$$

$$\Rightarrow S_2 = \frac{420 \times 1125}{875} = 540$$

31. (b) Suppose B puts in x cows. The ratio of (a)'s and B's rents

$$= 1:1 \frac{1}{2} : 1:\frac{3}{2} \quad 2:3$$

$$\text{Then, } \frac{100 \times 8}{x \times 2} \frac{2}{3} \text{ or, } x = \frac{100 \times 8 \times 3}{2 \times 2} = 600$$

cows.

32. (c) Let (c) completes the work in x days.

$$\text{Work done by ((a) + (b)) in 1 day} = \frac{1}{10}$$

$$\text{Work done by ((b) + (c)) in 1 day} = \frac{1}{18}$$

$$\text{(a)'s 5 days' work + (b)'s 10 days' work + (c)'s 15 days' work} = 1$$

$$\text{or ((a) + (b))'s 5 days' work + ((b) + (c))'s 5 days' work}$$

$$+ \text{(c)'s 10 days' work} = 1$$

$$\text{or } \frac{5}{10} \frac{5}{18} \frac{10}{x} \quad 1 \text{ or } x = 45 \text{ days}$$

33. (a) Let the length of the journey = x km.

\therefore Journey rides by horse cart

$$= x \left(1 - \frac{1}{2} - \frac{1}{3} \right) = \frac{1}{6} x \text{ km.}$$

Then, total time taken to complete journey

$$\frac{31}{5} \text{ hr}$$

$$\Rightarrow t_1 \quad t_2 \quad t_3 \quad \frac{31}{5}$$

$$\Rightarrow \frac{x}{2} \times \frac{1}{4} + \frac{x}{3} \times \frac{1}{12} + \frac{x}{6 \times 9} + \frac{31}{5}$$

$$\Rightarrow x = \frac{31}{5} \times \frac{216}{37} = 36.2 \text{ km} \approx 36 \text{ km}$$

34. (b) Perimeter = Distance covered in 8 min.

$$= \left(\frac{12000}{60} \times 8 \right) \text{ m} = 1600 \text{ m.}$$

Let length = $3x$ metres and breadth = $2x$ metres.

Then, $2(3x + 2x) = 1600$ or $x = 160$.

\therefore Length = 480 m and (b) breadth = 320 m.

\therefore (a) area = $(480 \times 320) \text{ m}^2 = 153600 \text{ m}^2$.

35. (d) Let C.P. = ₹ x . Then,

$$\text{S.P.} = \frac{(100-7)}{100} \times x = \frac{93}{100} x$$

$$\text{(a) Also, } \left(\frac{93}{100} x + 48 \right) \frac{100}{(100-5)} = x$$

$$\Rightarrow 93x + 4800 = 105x$$

$$\Rightarrow 12x = 4800 \Rightarrow x = \text{Rs } 400$$

36. (c) Net part filled in 1 hour

$$= \left(\frac{1}{5} - \frac{1}{6} - \frac{1}{12} \right) \frac{17}{60}$$

\therefore The tank will be full in $\frac{60}{17}$ hrs i.e., $3 \frac{9}{17}$

hrs.

37. (c) Let the husband and the wife meet after x minutes. 4500 metres are covered by Pradeep in 60 minutes.

In x minutes, he will cover $\frac{4500}{60}x$ metres.

Similarly,

In x minutes, his wife will cover $\frac{3750}{60}x$ m.

$$\text{Now, } \frac{4500}{60}x + \frac{3750}{60}x = 726$$

$$\Rightarrow x = \frac{726 \times 60}{8250} = 5.28 \text{ min}$$

38. (d) $\frac{2a}{a} - \frac{b}{4b} = 3 \Rightarrow 2a - \frac{b}{4} = 3(a - 4b) \Rightarrow a = -11b$

$$\therefore \frac{a+b}{a+2b} = \frac{-11b+b}{-11b+2b} = \frac{-10b}{-9b} = \frac{10}{9}$$

39. (c) $x - \frac{1}{x} = 5$

On squaring both sides,

$$x^2 + \frac{1}{x^2} - 2 = 25 \Rightarrow x^2 + \frac{1}{x^2} = 27$$

40. (c) $P \sin \theta = \sqrt{3}$... (i)
 $P \cos \theta = 1$... (ii)

From Eqs. (i) and (ii),

$$\frac{P \sin \theta}{P \cos \theta} = \frac{\sqrt{3}}{1}$$

$$\Rightarrow \tan \theta = \sqrt{3}$$

$$\tan \theta = \tan 60^\circ$$

$$\therefore \theta = 60^\circ$$

From Eq. (i),

$$P \sin \theta = \sqrt{3} \Rightarrow P \sin 60^\circ = \sqrt{3}$$

$$\Rightarrow P \cdot \frac{\sqrt{3}}{2} = \sqrt{3}$$

$$\therefore P = 2$$

41. (b) (A) petal is a part of a flower; a tire is a part of a bicycle.

42. (d) First number = 8 and the sum of the digits of the second number is $2 + 8 = 10$.

Thus, the difference of the first number and the sum of the digits of second number is $10 - 8 = 2$.

Similarly, the sum of the digits of third number is $2 + 7 = 9$.

Hence, the sum of digits of fourth number should be 2 more than 9 i.e. 11 and $6 + 5 = 11$

Hence, (d) 65 is the correct option.

43. (d) First letter move 3 step forward and second letter move 2 step forward.

44. (a) Google is a search engine while others are internet browsers.

45. (a) 1st Letter:

$$L \xrightarrow{1} M \xrightarrow{1} N \xrightarrow{1} O \xrightarrow{1} \boxed{P}$$

2nd Letter :

$$X \xrightarrow{-4} T \xrightarrow{-4} P \xrightarrow{-4} L \xrightarrow{-4} \boxed{H}$$

3rd Letter :

$$F \xrightarrow{4} J \xrightarrow{4} N \xrightarrow{4} R \xrightarrow{4} \boxed{V}$$

46. (c) $16 = 5 \times 3 + 1$, $51 = 16 \times 3 + 3$,
 $158 = 51 \times 3 + 5$

$$\therefore \text{Next term} = 158 \times 3 + 7 = 481$$

47. (b) The pattern is, aabbcc/aabbcc/aabbcc. The pattern aabbcc is repeated.

48. (b) MUS(c)LE

49. (c) Each letter in the word is moved one step backward to obtain the corresponding letter of the code.

50. (a) The first, second, third, fourth, fifth and sixth letters of the word are respectively moved two, three, four, five, six and seven steps forward to obtain the corresponding letters of the code.

51. (b) There is no 'U' in the word INFL(a)TION(a)RY.

52. (b) Let uncle's present age = x

Rahim's present age = y

$$y - x = 30 \quad \dots(i)$$

(a)fter 7 year

$$(x + 7) + (y + 7) = 66$$

$$x + y + 14 = 66$$

$$x + y = 52 \quad \dots(ii)$$

combining (i) and (ii) we get

$$(x + y = 52) + (x - y = 30)$$

$$2x = 82$$

$$x = 41$$

Uncle's age is 41

53. (d)

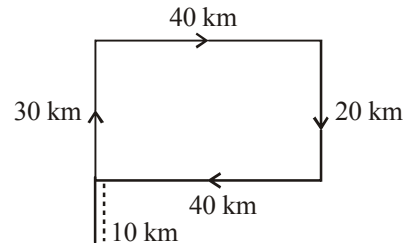

54. (b) In the original group of digits '7' is fourth from the right, which is interchanged with '9'. The new series is 2781359046. 9 will be 4th from the right end.
55. (c) The correct order is:

Pressure Rain Flood Protect Relief
 2 4 5 1 3

56. (d) Lady's mother's husband → Lady's father
 Lady's father's sister → Lady's (a)unt.
 So, Lady's aunt is man's aunt and therefore lady is man's sister.

57. (a)

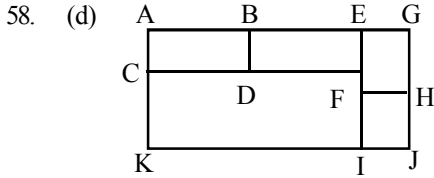

□(a)(b)(c)D, □(b)EDF, □ EGFH, □ FHIJ,

□ (a)E(c)F, □ EGJI, □ (c)FIK, □

(a)GJK, □ (a)EIK

59. (d) On interchanging - and ÷,
 We get the equation as
 $5 + 3 \times 8 \div 12 - 4 = 3$
 or $5 + 3 \times 2/3 - 4 = 3$
 or $3 = 3$, which is true

60. (b) $7 + 2^2 + 5 = 16$
 $9 + 4^2 + 7 = 32$
 $8 + 3^2 + 6 = 23$

61. (c) $3 + 9 - 5 = 7$
 $2 + 8 - 6 = 4$
 $4 + 7 - 5 = 6$

62. (d)

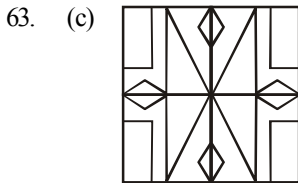

64. (c)

65. (b) When the sheet in fig. (X) is folded to form a cube, then 'F' appears opposite '(c)' and '(a)' appears opposite 'D'. Therefore, the cube in fig. (a) which shows 'F' adjacent to

'(b)', the cube in fig.(c) which shows 'E' adjacent to '(c)' and the cube in fig. (D) which shows '(a)' adjacent to 'D' cannot be formed.

66. (d)

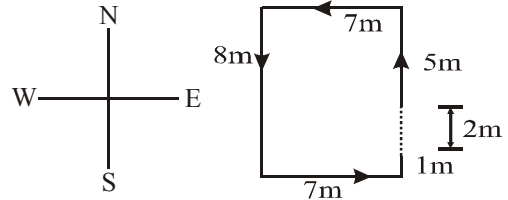

67. (d) (c)oding for: I D E (a) S
 $-1\downarrow +1\downarrow -1\downarrow +1\downarrow -1\downarrow$
 H E D (b) R
 (c)oding for: W O U L D
 $-1\downarrow +1\downarrow -1\downarrow +1\downarrow -1\downarrow$
 V P T M (c)
 Similarly, R I G H T
 $-1\downarrow +1\downarrow -1\downarrow +1\downarrow -1\downarrow$
 Q J F I S

(Qs. 68-70).

Formation of fig according to information given

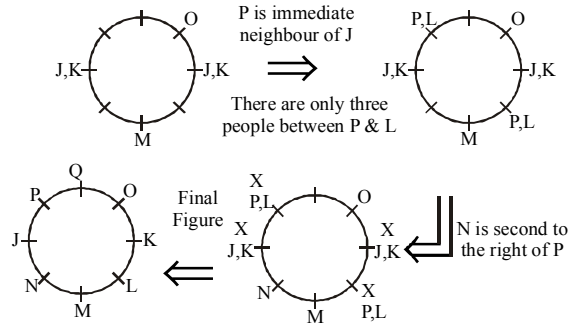

68. (b) N is immediate neighbour of J.
 69. (a) 'K' is second to the left of 'Q' and 'M' is second to the left of 'K'.
 70. (d) PQ, KL, MN, QO are in clockwise way and KO in anticlockwise way.
 71. (d)
 72. (d) The given arrangement is:

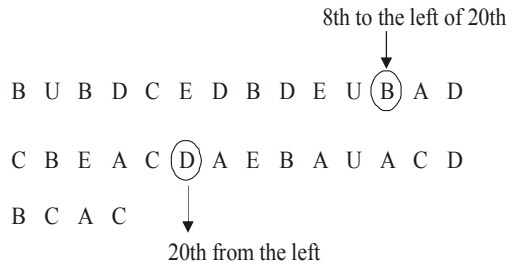

73. (b) B U C E
C U B E

74. (c) Given that

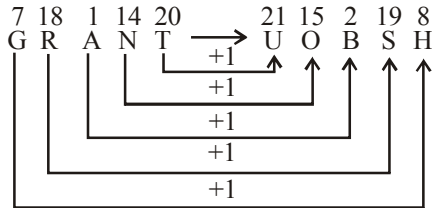

and

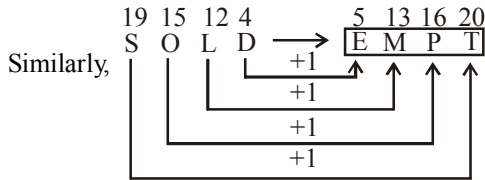
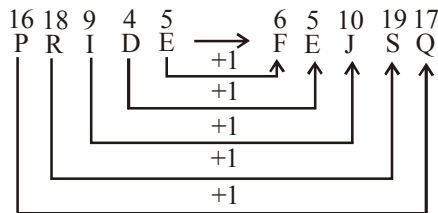

∴ SOLD ⇒ EMPT

75. (d) (a)ll others are prime number Except 27.
 76. (b) Second, Fourth, sixth and seventh letters of word “STUM(b)LE” are T, M, L & E respectively and meaningful word made by then letter is ‘MELT’
 77. (b) Given letter series:-
 2 5 7 10 12 15 17 20 22 25
 B E G J L O Q T V Y
 +3 +2 +3 +2 +3 +2 +3 +2 +3
 ⇒ ? = V Y
 78. (d) (a)ccording to question.

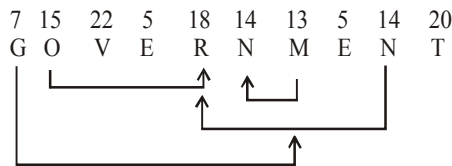

Such couple are G - M, O - R, M - N and N - R and is more than three.

Solution : 78

$P \$ Q \Rightarrow P \geq Q$

$P @ Q \Rightarrow P \leq Q$

$P \delta Q \Rightarrow P > Q$

$P \# Q \Rightarrow P < Q$

$P \% Q \Rightarrow P = Qs$

79. (d) (a) live is different from the other four words. Walk, (c)ry, Play and Study are various actions of human being. (a)live means 'living', 'not dead', 'in existence', 'continuing' etc.

80. (b) V I R T U A L
 22 9 18 20 21 I 12
 V I R T U A L
 81. (c) The four classes were mentioned in Purush Sukta in 10th mandal of Rigveda.
 82. (b) According to the Article 243 K (1), the chief of the State Election Commission is appointed by the Governor.
 83. (a) Blue-green algae or Cyanobacteria are microscopic cells that grow naturally in Australian fresh and salt waters. They are a type of bacteria, but in some ways act like plants by using sunlight to manufacture carbohydrates from carbon dioxide and water, a process known as photosynthesis. In doing so, they release oxygen. They grow in dams, rivers, creeks, reservoirs, lakes and even hot springs.
 84. (b) Non- plan expenditure is largely the revenue expenditure of the government, although it also includes capital expenditure. It covers all expenditure not included in the Plan Expenditure. Non-Plan Expenditure constitutes the biggest proportion of the government's total expenditure. The biggest items of Non-Plan Expenditure are interest payments and debt servicing, defence expenditure and subsidies. For defence services, both revenue and capital expenditure are incurred.
 85. (c) Any session of the state legislation is prorogated by the Governor.
 86. (b)
 87. (d) Hathigumpha inscription was built by Kharvel in Odisha, near Bhuvneshwar.
 88. (d) The right to equality before the law contained in article 14 of the Constitution of India is available to all persons whether natural or legal.

89. (c) The adjournment motion is thus an extraordinary procedure which, if admitted, leads to setting aside the normal business of the House for discussing a definite matter of urgent public importance.
90. (c) "The Man who Divided India" was written by Rafiq Zakaria.
91. (c) Peshawar was known as Purushpur in ancient times. It was the capital of Kushana ruler Kanishka.
92. (a) Mayo came in India in 1869. He founded Mayo College in Ajmer. He was killed by an Afghan in 1872.
93. (a) Erythroblastosis fetalis is hemolytic anemia in the fetus (or neonate, as erythroblastosis neonatorum) caused by transplacental transmission of maternal antibodies to fetal RBCs. The disorder usually results from incompatibility between maternal and fetal blood groups, often Rh0(D) antigens. Diagnosis begins with prenatal maternal antigenic and antibody screening and may require paternal screening, serial measurement of maternal antibody titers, and fetal testing. Treatment may involve intrauterine fetal transfusion or neonatal exchange transfusion. Prevention is Rh0(D) immune globulin injection for women at risk.
94. (a) Effective Revenue Deficit is the difference between revenue deficit and grants for creation of capital assets. In other words, the Effective Revenue Deficit excludes those revenue expenditures which were done in the form of grants for creation of capital assets aka GoCA.
Such grants include the grants given under: Pradhan Mantri Gram Sadak Yojana Accelerated Irrigation Benefit Programme Jawaharlal Nehru National Urban Renewal Mission MGNREGA etc.
95. (d) Eosin is a dye used to prepare red ink.
96. (d) India joined the IMF on December 27, 1945, as one of the IMF's original members. India accepted the obligations of Article VIII of the IMF Articles of Agreement on current account convertibility on August 20, 1994.
97. (c)
98. (c) The air bubble will behave as a diverging lens due to its bulging curvature.
99. (a) 100. (c) 101. (b) 102. (c)
103. (b) 104. (d) 105. (a) 106. (a)
107. (c) 108. (d) 109. (c) 110. (c)
111. (a) 112. (b) 113. (b) 114. (b)
115. (d)
116. (c) Chief Minister of Uttar Pradesh, Akhilesh Yadav launched a state-wide integrated emergency service UP-100 in Lucknow on November 19, 2016. The UP-100 is the official name for Uttar Pradesh Police Emergency Management System which was previously called dial 100 project to provide emergency services relating to public safety across the state round the clock.
117. (b) Indian-American author Amitav Ghosh has been named for the 2016 Tata Literature Live! Lifetime Achievement Award in recognition of his outstanding contribution to the Indian literary space.
118. (a)
119. (c) Himachal Pradesh State Industries Minister Mukesh Agnihotri announced that Himachal Pradesh has emerged as a hub of drug manufacturing units and meets 35 % of Pharma products demands in Asia.
120. (d) Former World No.1 Trap shooting champion Manavjit Singh Sandhu clinched the gold medal in men's trap event at the 60th National Shooting Championship for Shotgun in Jaipur on Saturday.

ARITHMETIC

- A number being successively divided by 3, 5 and 8 leaves 1, 2 and 4 as remainders respectively. What are the remainders if the order of divisors be reversed?
 - 3, 3, 1
 - 3, 1, 3
 - 1, 3, 3
 - None of these
- Find the unit digit in the product $(2467)^{153} \times (341)^{72}$.
 - 6
 - 7
 - 8
 - 9
- A shopkeeper bought 30 kg of wheat at the rate of ₹45 per kg. He sold forty per cent of the total quantity at the rate of ₹50 per kg. Approximately, at what price per kg should he sell the remaining quantity to make 25 percent overall profit?
 - ₹ 54
 - ₹ 52
 - ₹ 50
 - ₹ 60
- 4 goats or 6 sheeps can graze a field in 50 days. 2 goats and 9 sheeps can graze the field in
 - 100 days
 - 75 days
 - 50 days
 - 25 days
- If two numbers are respectively 20% and 50% of a third number, what is the percentage of the first number to the second?
 - 10
 - 20
 - 30
 - 40
- If the manufacturer gains 10%, the wholesale dealer 15% and the retailer 25%, then find the cost of production of a table, the retail price of which is ₹ 1265?
 - ₹ 800
 - ₹ 1000
 - ₹ 900
 - ₹ 600
- Out of a certain sum, $\frac{1}{3}$ rd is invested at 3%, $\frac{1}{6}$ th at 6% and the rest at 8%. If the simple interest for 2 years from all these investments amounts to ₹ 600, find the original sum.
 - ₹ 4000
 - ₹ 5000
 - ₹ 6000
 - ₹ 7000
- If the difference between S.I and C.I for 2 years on a sum of money lent at 5% is ₹ 6, then the sum B.
 - ₹ 2200
 - ₹ 2400
 - ₹ 2600
 - ₹ 2000
- A contractor undertakes to built a walls in 50 days. He employs 50 peoples for the same. However after 25 days he finds that only 40% of the work is complete. How many more man need to be employed to complete the work in time?
 - 25
 - 30
 - 35
 - 20
- In the adjoining the figure, points A, B, C and D lie on the circle. $AD = 24$ and $BC = 12$. What is the ratio of the area of the triangle CBE to that of the triangle ADE

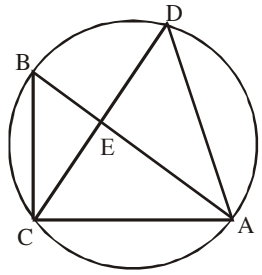

 - 1 : 4
 - 1 : 2
 - 1 : 3
 - Insufficient data
- Find the co-ordinates of the point which divides the line segment joining the points (4, -1) and (-2, 4) internally in the ratio 3 : 5
 - $\left(\frac{6}{4}, \frac{7}{2}\right)$
 - $\left(\frac{4}{7}, \frac{8}{7}\right)$
 - $\left(\frac{7}{4}, \frac{7}{8}\right)$
 - $\left(\frac{7}{12}, \frac{8}{4}\right)$

12. In the given fig. $AB \parallel QR$, find the length of PB.

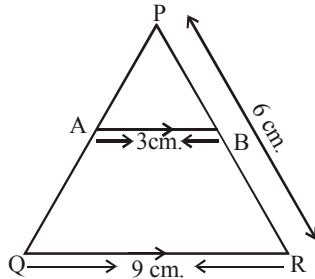

- (a) 3 cm (b) 2 cm (c) 4 cm (d) 6 cm
13. A triangle and a parallelogram are constructed on the same base such that their areas are equal. If the altitude of the parallelogram is 100 m, then the altitude of the triangle is :
- (a) 100m (b) 200m
(c) $100\sqrt{2}$ m (d) $10\sqrt{2}$ m
14. In a 800 m race around a stadium having the circumference of 200 m, the top runner meets the last runner on the 5th minute of the race. If the top runner runs at twice the speed of the last runner, what is the time taken by the top runner to finish the race ?
- (a) 20 min (b) 15 min
(c) 10 min (d) 5 min
15. If $\tan \theta = \frac{1}{\sqrt{7}}$, then $\frac{\operatorname{cosec}^2 \theta - \sec^2 \theta}{\operatorname{cosec}^2 \theta + \sec^2 \theta}$?
- (a) $\frac{5}{7}$ (b) $\frac{3}{7}$ (c) $\frac{1}{12}$ (d) $\frac{3}{4}$
16. If $y = \frac{2 \sin \alpha}{1 + \cos \alpha + \sin \alpha}$ then $\frac{1 - \cos \alpha + \sin \alpha}{1 + \sin \alpha}$ is equal to
- (a) $1/y$ (b) y
(c) $1 - y$ (d) $1 + y$
17. If $\theta + \phi = \frac{\pi}{6}$, what is the value of $(\sqrt{3} + \tan \theta)(\sqrt{3} + \tan \phi)$?
- (a) 1 (b) -1 (c) 4 (d) -4
18. If $x = 2 + \sqrt{3}$, then $x^2 + \frac{1}{x^2}$ is equal to
- (a) 10 (b) 12
(c) -12 (d) 14

19. If $a^2 + b^2 + c^2 = 2a - 2b - 2$, then the value of $3a - 2b + c$ is
- (a) 0 (b) 3
(c) 5 (d) 2
20. The least value of $3^x - 3^{-x}$ is :
- (a) 2 (b) 1
(c) 0 (d) $\frac{2}{3}$

DIRECTIONS (Q. 21-23) : Study the following pie-chart carefully and answer the questions given below.

Cost estimated by a family in renovation of their house

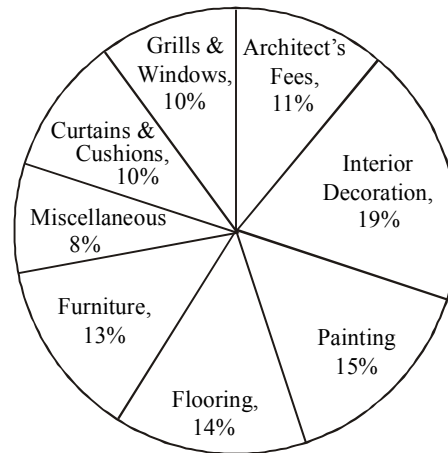

Total estimated cost is ₹1,20,000

21. What is the difference in the amount estimated by the family on interior decoration and that on architect's fees?
- (a) ₹10,000 (b) ₹9,500
(c) ₹7,200 (d) ₹9,600
22. During the process of renovation, the family actually incurred miscellaneous expenditure of ₹10,200. The miscellaneous expenditure incurred by the family is what percentage of the total estimated cost?
- (a) 9.5% (b) 9%
(c) 8.5% (d) 10.5%
23. Other than getting the discount of 12% on the estimated cost of furniture and the actual miscellaneous expenditure being ₹10,200 instead of the estimated one, the family's estimated cost is correct. What is the total amount spend by the family in renovating its house?
- (a) ₹1,16,728 (b) ₹1,15,926
(c) ₹1,19,500 (d) ₹1,18,728

24. The length of a rectangular plot is thrice its breadth. If the area of the rectangular plot is 7803 sq. metre, what is the breadth of the rectangular plot?
 (a) 51 metres (b) 153 metres
 (c) 104 metres (d) 88 metres
25. A cylindrical tube open at both ends is made of metal. The internal diameter of the tube is 6 cm and length of the tube is 10 cm. If the thickness of the metal used is 1 cm, then the outer curved surface area of the tube is
 (a) 140π sq cm (b) 146.5π sq cm
 (c) 70π sq cm (d) None of these
26. Given that $0.111 \dots \frac{1}{9}$; 0.444 is equal to :
 (a) $\frac{1}{90}$ (b) $\frac{2}{45}$ (c) $\frac{1}{99}$ (d) $\frac{4}{9}$
27. If $x = 1 - \sqrt{2}$ and $y = 1 - \sqrt{2}$, find the value of $(x^2 + y^2)$.
 (a) 6 (b) -1 (c) 2 (d) 5
28. What least number must be subtracted from 1936 so that the remainder when divided by 9, 10, 15 will leave in each case the same remainder 7?
 (a) 29 (b) 39 (c) 49 (d) 59
29. The respective ratio between the speeds of a car, a train and a bus is 5 : 9 : 4. The average speed of the car, the bus and the train is 72 km/h together. What is the average speed of the car and the train together ?
 (a) 82 km/h
 (b) 78 km/h
 (c) 84 km/h
 (d) Cannot be determined
30. If 11 lichchus are bought for 10 paise and 10 lichchus are sold for 11 paise, the gain % is
 (a) 10% (b) 11% (c) 20% (d) 21%
31. There are two numbers such that the sum of twice the first number and thrice the second number is 141 and the sum of thrice the first number and twice the second number is 174. Which is the larger number?
 (a) 52 (b) 36 (c) 48 (d) 24
32. 24 men working 8 hours a day can finish a work in 10 days. Working at the rate of 10 hours a day, the number of men required to finish the same work in 6 days is :
 (a) 30 (b) 32 (c) 34 (d) 36
33. R and S start walking each other at 10 AM at the speeds of 3 km/h and 4 km/h respectively. They were initially 17.5 km apart. At what time do they meet?
 (a) 2 : 30 PM (b) 11 : 30 AM
 (c) 1 : 30 PM (d) 12 : 30 PM
34. A wire can be bent in the form of a circle of radius 56 cm. If it is bent in the form of a square, then its area will be:
 (a) 3520 cm^2 (b) 6400 cm^2
 (c) 7744 cm^2 (d) 8800 cm^2
35. A sells a tube to B at a profit of 20% and B sells it to C at profit of 25 %. If C pays ₹ 225 for it, what did A pay for it?
 (a) ₹ 100 (b) ₹ 125
 (c) ₹ 150 (d) ₹ 175
36. Two pipes can fill a cistern in 14 and 16 hours respectively. The pipes are opened simultaneously and it is found that due to leakage in the bottom, 32 minutes extra are taken for the cistern to be filled up. If the cistern is full, in what time would the leak empty it ?
 (a) 110 hr (b) 112 hr
 (c) 115 hr (d) 100 hr
37. A plane left 30 minutes later than the scheduled time and in order to reach the destination 1500 km away in time, it had to increase the speed by 250 km/h from the usual speed. Find its usual speed.
 (a) 720 km/h (b) 740 km/h
 (c) 730 km/h (d) 750 km/h
38. If $(2a + 3b)(2c - 3d) = (2a - 3b)(2c + 3d)$, then :
 (a) $\frac{a}{b} = \frac{c}{d}$ (b) $\frac{a}{d} = \frac{c}{b}$
 (c) $\frac{a}{b} = \frac{d}{c}$ (d) $\frac{b}{a} = \frac{c}{d}$
39. If $x = 3 + 2\sqrt{2}$, then the value of $\left(\sqrt{x} - \frac{1}{\sqrt{x}}\right)$ is :
 (a) 1 (b) 2
 (c) $2\sqrt{2}$ (d) $3\sqrt{3}$
40. If $\sin(x + y) = \cos[3(x + y)]$, then the value of $\tan[2(x + y)]$ is
 (a) 1 (b) 0
 (c) $\frac{1}{\sqrt{3}}$ (d) $\sqrt{3}$

GENERAL INTELLIGENCE & REASONING

DIRECTIONS (Qs. 41-43) : In the questions, select the related word/ letters/numbers from the given alternatives.

41. ACE : FHJ :: OQS : ?
 (a) PRT (b) RTU
 (c) TVX (d) UWY
42. Saint : Meditation :: Scientist : ?
 (a) Research (b) Knowledge
 (c) Spiritual (d) Rational
43. 7 : 56 :: 9 : ?
 (a) 63 (b) 81 (c) 90 (d) 99

DIRECTIONS (Qs. 44-45): In the following question, find the odd word/number from the given alternative.

44. (a) Lord Dalhousie (b) Lord Mountbatten
 (c) Lord Linlithgow (d) Lord Tennyson
45. (a) 226 (b) 290
 (c) 360 (d) 170

DIRECTIONS (Qs. 46-47): In the following question a series is given, with one term missing. Choose the correct alternative from the given ones that will complete the series.

46. AYBZC, DWEXF, GUHVI, JSKTL, (?), POQPR
 (a) MQDRN (b) QMONR
 (c) MQNRO (d) NQMOR
47. 8, 15, 28, 53, ...?
 (a) 98 (b) 106 (c) 100 (d) 102
48. In a certain code language NATIONALISM is written as OINTANMSAIL. How is DEPARTMENTS written in that code?
 (a) RADEPTSTMNE (b) RADPETSTMNE
 (c) RADPESTMNE (d) RADPETSTNME
49. If 'green' is called 'white', 'white' is called 'yellow', 'yellow' is called 'red', 'red' is called 'orange', then which of the following represents the colour of sunflower?
 (a) red (b) yellow
 (c) brown (d) indigo
50. A man said to a woman, "Your mother's husband's sister is my aunt." How is the woman related to the man ?
 (a) Granddaughter (b) Daughter
 (c) Sister (d) Aunt

51. Rasik walks 20 m North. Then, he turns right and walks 30 m. Then he turns right and walks 35 m. Then he turns left and walks 15 m. Then he again turns left and walks 15 m. In which direction and how many metres away is he from his original position?
 (a) 15 metres West (b) 30 metres East
 (c) 30 metres West (d) 45 metres East
52. In a row of boys Akash is fifth from the left and Nikhil is eleventh from the right. If Akash is twenty-fifth from the right then how many boys are there between Akash and Nikhil?
 (a) 14 (b) 13 (c) 15 (d) 12
53. P, Q, R and S are four men. P is the oldest but not the poorest. R is the richest but not the oldest. Q is older than S but not than P or R. P is richer than Q but not than S. The four men can be ordered (descending) in respect of age and richness, respectively, as
 (a) PQRS, RPSQ (b) PRQS, RSPQ
 (c) PRQS, RSQP (d) PRSQ, RSPQ

DIRECTIONS (Qs. 54): Arrange the following in a logical order:

54. 1. Birth 2. Death
 3. Funeral 4. Marriage
 5. Education
 (a) 1, 3, 4, 5, 2 (b) 1, 5, 4, 2, 3
 (c) 2, 3, 4, 5, 1 (d) 4, 5, 3, 1, 2
55. Choose the diagram which represent the relationship among the following :- Capsules, Antibiotics, Injection.

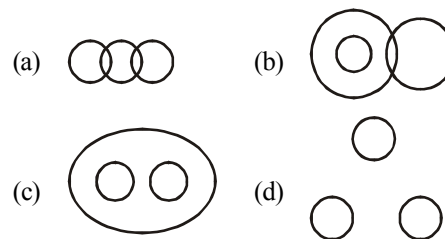

DIRECTIONS (Qs. 56) : In the question belows are given two statements followed by two conclusions. You have to take the given statements to be true even if they seem to be at variance with commonly known facts. Read all the conclusions and then decide which of the given statements disregarding commonly know facts. Given Answer.

- Give answer (a)** If only conclusion I follows.
Give answer (b) if only conclusion II follows.
Give answer (c) if either I or II follows.
Give answer (d) if neither I nor II follows.

56. Statements:

All leaders are good team workers.
All good team workers are good orators.

Conclusions:

- I.** Some good team workers are leaders.
- II.** All good orators are leaders.

57. If ‘-’ stands for division, ‘+’ for multiplication ‘÷’ for subtraction and ‘×’ for addition. Which one of the following equation is correct?

- (a) $6 \div 20 \times 12 + 7 - 1 = 70$
- (b) $6 + 20 - 20 \div 7 \times 1 = 62$
- (c) $6 - 20 \div 12 \times 7 + 1 = 57$
- (d) $6 + 20 - 20 \div 7 - 1 = 38$

DIRECTIONS (Qs.58–59): In the following questions, select the missing number from the given response.

- 58.**
- | | | |
|---|---|---|
| 2 | 7 | 9 |
| 7 | 3 | 4 |
| 9 | 8 | ? |
- 126 168 216
- (a) 8 (b) 3 (c) 6 (d) 36

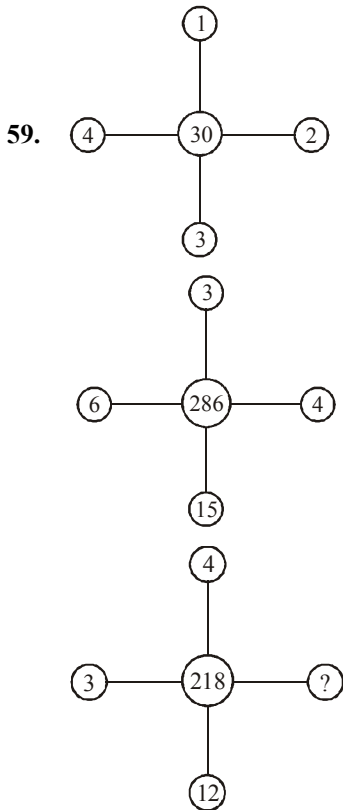

- (a) 6 (b) 7 (c) 9 (d) 12

Directions (Qs. 60): Choose the box that is similar to the box formed from the given sheet of paper (X).

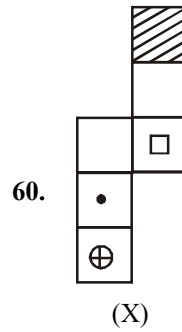

- (1) (2) (3) (4) (a) 1 only (b) 2 and 3 only (c) 1 and 3 only (d) 1, 2 and 4 only

61. How many triangles are there in the figure ABCDEF?

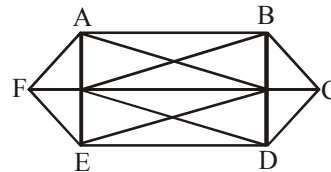

- (a) 24 (b) 26
(c) 28 (d) 30

Directions (Qs. 62): From the given answer figures, select the one which is hidden/embedded in the question figure.

- 62.**
-
- (X)
- (a) (b) (c) (d) (a) (b) (c) (d)

DIRECTIONS (Qs. 63) : In the question a set of three figures A, B and C showing a sequence of folding of a piece of paper. Fig. (C) shows the manner in which the folded paper has been cut. These three figures are followed by four answer figures from which you have to choose a figure which would most closely resemble the unfolded form of fig. (C).

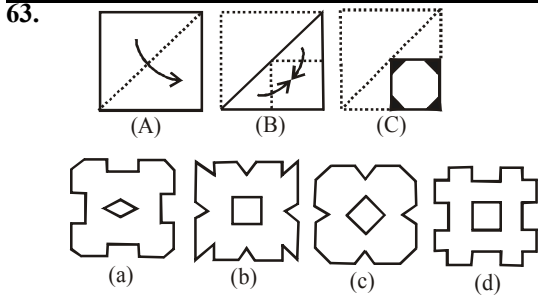

DIRECTIONS (Q.64): In the following question, which answer figure will complete the pattern in the question figure?

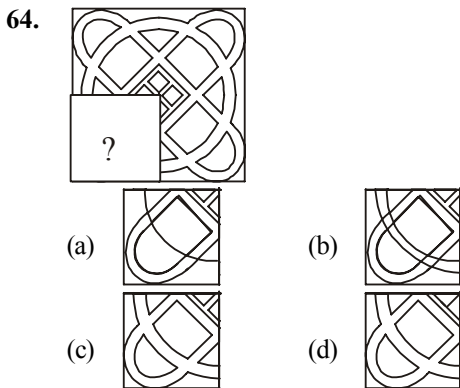

65. From the given alternative words, select the word which cannot be formed using the letters of the given word :
TRIVANDRUM
(a) RAIN (b) DRUM
(c) TRAIN (d) DRUK
66. How many meaningful English words can be formed with the letters 'ILP' using all the letters only once in each word ?
(a) None (b) One (c) Two (d) Three
67. If each alternate letter in the word 'FLIPPER' starting with F is changed to the next letter in the English alphabetical series and each of the remaining letters is changed to the previous letters in the English alphabetical series then how many letters will appear more than once in the new arrangement ?

- (a) None (b) One
(c) Two (d) Three
68. Pointing to a girl, Mr. Arun said. "She is the daughter of my mother's only child". How is the girl related to Mr. Arun ?
(a) Sister (b) Mother
(c) Cousin (d) Daughter

DIRECTIONS (Qs. 69-71) : Study the following information to answer the given questions :

Eight friends A, B, C, D, E, F, G and H are sitting around a circle facing the centre, not necessarily in the same order. F sits fourth to the left of B. A and H are immediate neighbours of F. C sits third to the left of A. G sits third to the right of E.

69. What is D's position with respect to B ?
(a) Immediate left (b) Sixth to the right
(c) Second to the left (d) Seventh to the left
70. What are the immediate neighbours of G ?
(a) F and H (b) A and F
(c) C and H (d) B and C
71. If C is related to E in a certain way and similarly F is related to B in the same way, to whom is A related to ?
(a) H (b) D (c) G (d) C

DIRECTIONS (Qs. 72-74) : In each question below is given a group of numbers/symbols followed by five combinations of letter codes numbered (a), (b), (c), (d) and (e). You have to find out which of the combinations correctly represents the group of numbers/symbols based on the following coding system and the conditions and mark the number of that combination as your answer.

Number/Symbols	9	4	&	5	%	3	#	7	6	@	8	+	2	\$
Letter Codes	X	P	J	H	B	D	K	F	S	T	N	G	R	L

- Conditions:**
- (i) If the first element is a symbol and the last element is a number, then the codes for both are to be interchanged.
- (ii) If both the first and last elements are symbols, then the last element is to be coded as the code for the first element.
- (iii) If the group of elements contains only one symbol, then that symbol is to be coded as A.
72. 28%956
(a) RNBXHS (b) RNAXSH
(c) RNBXSH (d) RNAXHS

73. ©62+74
 (a) PSRGFT (b) TSRFGP
 (c) PSRFGT (d) PRSGFT
74. +5963%
 (a) GHXSDG (b) GSHXDB
 (c) GHXDSG (d) GHSXDB
75. In a certain code, a number 13479 is written as AQFJL and 2568 is written as DMPN. How is 396824 written in that code?
 (a) QLPNMJ (b) QLPNMF
 (c) QLPMNF (d) QLPNDF
76. In the following sequence or instructions, 1 stands for Run, 2 stands for Stop, 3 stands for Go, 4 stands for Sit and 5 stands for Wait. If the sequence is continued, which instruction will come next?
 4 4 5 4 5 3 4 5 3 1 4 5 3 1 2 4 5 4 5 3 4 5 3
 (a) Wait (b) Sit (c) Stop (d) Run
77. If the first and second letters in the word DEPRESSION were interchanged, also the third and the fourth letters, the fifth and the sixth letters and so on, which of the following would be the seventh letter from the right?
 (a) R (b) O (c) S (d) P
78. In a certain code 'na pa ka so' means 'birds fly very high', 'ri so la pa' means 'birds are very beautiful' and 'ti me ka bo' means 'the parrots could fly'. Which of the following is the code for 'high' in that language?
 (a) na (b) ka (c) bo (d) so
79. If 'P' denotes '-'; 'Q' denotes '+', 'R' denotes '×' and 'W' denotes '÷' then-
 48 Q 12 R 10 P 8 W 4 = ?
 (a) 56 (b) 40
 (c) 52 (d) None of these
80. Laxman went 15 km to the west from my house, then turned left and walked 20 km. He then turned East and walked 25 km and finally turning left covered 20 km. How far was he from my house?
 (a) 5km (b) 10km (c) 40km (d) 80km
81. When did Delhi first become capital of a kingdom?
 (a) At the time of Tomar dynasty
 (b) Tughlaq dynasty
 (c) Lodhi dynasty
 (d) None of these
82. Total schedules in Indian Constitution are:
 (a) 22 (b) 10 (c) 16 (d) 12
83. Who was the President of the Constituent Assembly?
 (a) Rajendra Prasad (b) B. R. Ambedkar
 (c) K. M. Munshi (d) G. V. Mavlankar
84. By Which name/names is our country mentioned in the constitution?
 (a) India and Bharat
 (b) India and Hindustan
 (c) Bharat Only
 (d) India, Bharat and Hindustan
85. Per capita Income of a country derived from
 (a) National Income
 (b) Population
 (c) National Income and Population both
 (d) None of these
86. Which one of the following agencies of Indian Government implements the price support scheme (PSS)?
 (a) FCI (b) NAFED
 (c) Agriculture pricing agency of India
 (d) None of the above
87. 'Udyog Bandu' is a/an ?
 (a) labour supplying agency
 (b) sick Industry rehabilitation agency
 (c) committee to assist industrial units in solving time bound establishment and related problems
 (d) agency for financing industrial development
88. Which one of the following is a vector quantity?
 (a) Momentum (b) Pressure
 (c) Energy (d) Work
89. The working principle of a washing machine is :
 (a) centrifugation (b) dialysis
 (c) reverse osmosis (d) diffusion
90. Acid rain is caused by the pollution of environment by
 (a) carbon dioxide and nitrogen
 (b) carbon monoxide and carbon dioxide
 (c) ozone and carbon dioxide
 (d) nitrous oxide and sulphur dioxide
91. The wine is prepared by the process of
 (a) fermentation (b) catalysation
 (c) conjugation (d) displacement
92. Which one of the following hormones contains iodine?
 (a) Thyroxine (b) Testosterone
 (c) Insulin (d) Adrenaline

GENERAL AWARENESS

81. Which of the following is not evident at Mohenjodaro?
 (a) Pasupati seal
 (b) Great granary and great bath
 (c) Multi-pillared assembly hall
 (d) Evidence of double burials
82. Which one of the following is not a part of early Jains literature?
 (a) Therigatha (b) Acarangasutra
 (c) Suttrakritanga (d) Brihatkalpasutra

95. The major component of honey is
 (a) glucose (b) sucrose
 (c) maltose (d) fructose
96. In eye donation, which one of the following parts of donor's eye is utilized?
 (a) Iris (b) Lens (c) Cornea (d) Retina
97. Octopus is
 (a) an arthropod (b) an echinoderm
 (c) a hemichordate (d) a mollusc
98. Who is the author of the book 'Harry Potter' and the 'Half-Blood Prince'?
 (a) Mark Twain (b) J. K. Rowling
 (c) William Shakespeare (d) Jules Verne
99. Which of the following games is **not** included in the Olympic Games?
 (a) Skiing (b) Cycling
 (c) Cricket (d) Archery
100. In context to India's defence structure 'Agni missile' is _____.
 (a) Surface-to-air (b) Air-to-air
 (c) Air-to-surface (d) Surface-to-surface
101. What does NPR stand for?
 (a) National Population Programme
 (b) National Population Project
 (c) National Population Register
 (d) National Population Production
102. The BASIC countries are a bloc of four larger developing countries. Which one of the following is not a BASIC country?
 (a) Brazil (b) Switzerland
 (c) India (d) China
103. NASA recently gave its approval to New Horizons mission to investigate a mysterious object in kuiper Belt. Name the mysterious object.
 (a) 2014 MU69 (b) 2014 MU68
 (c) 2015 MU69 (d) 2014 MV69
104. Which state has recently banned e-cigarettes?
 (a) Kerala (b) Nagaland
 (c) Assam (d) Bihar
105. The book "When Breath Becomes Air" has been authored by whom?
 (a) Ruskin Bond (b) Raj Kotwal
 (c) Paul Kalanithi (d) Zalmay Khalilzad
106. Applications are often referred to as
 (a) Data files (b) executable files
 (c) system software (d) the operating system
107. PC stands for
 (a) Personal Comprehension
 (b) Personal Computing
 (c) Personal Computer
 (d) Personal Calculations
108. A directory within a directory is called
 (a) Mini Directory (b) Junior Directory
 (c) Part Directory (d) Sub Directory
109. A(n) is created by an application.
 (a) executable file (b) software program
 (c) document (d) operating system
110. Compatibility in regard to computers refers to
 (a) the software doing the right job for the user
 (b) it being versatile enough to handle the job
 (c) the software being able to run on the computer
 (d) software running with other previously installed software
111. First underground railway (Metro Railway) started in which year?
 (a) 1982 (b) 1989
 (c) 1984 (d) 1992
112. Shatabdi Express train introduced in
 (a) 1984 (b) 1988
 (c) 1990 (d) 1985
113. At which of the following place Diesel Component Works is established ?
 (a) Jamshedpur (b) Patiala
 (c) Perambur (d) Warangal
114. _____ Zone is the largest in Indian Railways ?
 (a) Central Railway (b) Northern Railway
 (c) Eastern Railway (d) Western Railway
115. The railway station situated in the extreme south is
 (a) Chennai (b) Cochin
 (c) Kanyakumari (d) Trivandrum
116. Who launched Pradhan Mantri Grameen Awas Yojna in Agra?
 (a) Pranab Mukherjee (b) Rajnath Singh
 (c) Narendra Modi (d) Arun Jaitley
117. Where was a recent mock drill conducted by NSG?
 (a) Jammu & Kashmir (b) Punjab
 (c) Maharashtra (d) New Delhi
118. Which country has launched the world's longest secure quantum communication line?
 (a) China (b) Japan
 (c) USA (d) Russia
119. Who has been conferred with prestigious Mother Teresa International Award 2016?
 (a) Edwin Britto (b) Al Nahyan
 (c) Sayed Iqbal Haider
 (d) Ansar Burney
120. Which cricketer has become the first to take 50 wickets in two consecutive years?
 (a) Rohit Sharma
 (b) Ravichandran Ashwin
 (c) Murali Kartik
 (d) Ravindra Jadeja

Hints & Explanations

1. (a) Complete remainder = $d_1d_2r_3 + d_1r_2 + r_1$
 $= 3 \times 5 \times 4 + 3 \times 2 + 1 = 67$
 Divided 67 by 8, 5 and 3, the remainders are 3, 3, 1.
2. (b) Clearly, unit's digit in the given product = unit's digit in $7^{153} \times 1^{72}$.
 Now, 7^4 gives unit digit 1.
 $\therefore 7^{153}$ gives unit digit $(1 \times 7) = 7$.
 Also 1^{72} gives unit digit 1.
 Hence, unit's digit in the product = $(7 \times 1) = 7$.
3. (d) CP of wheat = $30 \times 45 = ₹1350$
 40% of 30 kg = 12 kg
 SP of 12 kg = $12 \times 50 = ₹600$
 For 25% profit, total SP of all the wheat is
 $1350 \times \frac{125}{100} = 1350 \times \frac{5}{4} = ₹ \frac{6750}{4} = ₹1687.5$
 Remaining wheat $(30 - 12) = 18$ kg.
 Rate of remaining wheat
 $= \frac{1087.5}{18} \approx ₹60$
4. (d) Given that
 1 Goats = $\frac{3}{2}$ sheeps.
 Now, 2 goats + 9 sheeps
 $= 2 \times \frac{3}{2}$ sheeps + 9 sheeps
 $= 12$ sheeps
 Here $M_1D_1 = M_2D_2$
 $\Rightarrow 6 \times 50 = 12 \times d_2$
 $d_2 = 25$ days
5. (d) Let the third number be 100. Then, the first and second numbers will be 20 and 50, respectively.
 Required % = $\frac{20}{50} \times 100 = 40\%$
6. (a) Let the cost of production of the table be ₹ x.
 Then, 125% of 115% of 110% of x = 1265
 $\Rightarrow \frac{125}{100} \times \frac{115}{100} \times \frac{110}{100} \times x = 1265$
 $\Rightarrow \frac{253}{160} x = 1265 \Rightarrow x = \left(\frac{1265 \times 160}{253} \right) = ₹800$
7. (b) Rest part = $1 - \left(\frac{1}{3} + \frac{1}{6} \right) = \frac{1}{2}$
 Rate % per annum on total sum
 $= \left(\frac{1}{3} \times 3 \right) + \left(\frac{1}{6} \times 6 \right) + \left(\frac{1}{2} \times 8 \right) = 6\%$
 $\therefore P = \frac{600 \times 100}{6 \times 2} = ₹5,000$
8. (b) Difference = $\frac{PR^2}{10000}$
 $\Rightarrow 6 = \frac{P \times 5 \times 5}{10000}$
 $\Rightarrow 6 \times 400 = ₹2400$.
9. (a) 50 men complete 0.4 work in 25 days.
 Applying the work rule,
 $m_1 \times d_1 \times w_2 = m_2 \times d_2 \times w_1$
 we have,
 $50 \times 25 \times 0.6 = m_2 \times 25 \times 0.4$
 or $m_2 = \frac{50 \times 25 \times 0.6}{25 \times 0.4} = 75$ men
 Number of additional men required
 $= (75 - 50) = 25$
10. (a) AD = 24, BC = 12
 In $\triangle BCE$ & $\triangle ADE$
 since $\angle CBA = \angle CDA$ (Angles by same arc)
 $\angle BCE = \angle DAE$ (Angles by same arc)
 $\angle BEC = \angle DEA$ (Opp. angles)
 $\therefore \triangle BCE$ & $\triangle ADE$ are similar Δ s
 with sides in the ratio 1 : 2
 Ratio of area = 1 : 4 (i.e. square of sides)
11. (c) Here $x_1 = 4, x_2 = -2, y_1 = -1, y_2 = 4$
 and $m_1 = 3$ and $m_2 = 5$
 $\therefore x = \frac{m_1x_2 - m_2x_1}{m_1 - m_2} = \frac{3(-2) - 5(4)}{3 - 5} = \frac{7}{4}$
 and
 $y = \frac{m_1y_2 - m_2y_1}{m_1 - m_2} = \frac{3(4) - 5(-1)}{3 - 5} = \frac{7}{8}$
 \therefore The required point is $\left(\frac{7}{4}, \frac{7}{8} \right)$

12. (b)
- $\Delta PAB \sim \Delta PQR$

$$\frac{PB}{AB} = \frac{PR}{QR} \Rightarrow \frac{PB}{3} = \frac{6}{9}$$

$$\therefore PB = 2 \text{ cm}$$

13. (b) Let the common base be
- x
- m.
-
- Now, area of the triangle = area of the parallelogram

$$\frac{1}{2} \times x \times \text{Altitude of the triangle} = x \times 100$$

$$\text{Altitude of the triangle} = 200 \text{ m}$$

14. (c) After 5 minutes (before meeting), the top runner covers 2 rounds i.e., 400 m and the last runner covers 1 round i.e., 200 m.
-
- \therefore
- Top runner covers 800 m race in 10 minutes.

15. (d) Given,
- $\tan \theta = \frac{1}{\sqrt{7}}$

$$\sec \theta = \sqrt{1 + \tan^2 \theta} = \sqrt{1 + \left(\frac{1}{\sqrt{7}}\right)^2} = \sqrt{\frac{8}{7}}$$

$$\operatorname{cosec} \theta = \frac{\sec \theta}{\tan \theta} = \frac{\sqrt{\frac{8}{7}}}{\frac{1}{\sqrt{7}}} = \sqrt{8}$$

$$\therefore \frac{\operatorname{cosec}^2 \theta - \sec^2 \theta}{\operatorname{cosec}^2 \theta + \sec^2 \theta} = \frac{\sqrt{8}^2 - \left(\sqrt{\frac{8}{7}}\right)^2}{\sqrt{8}^2 + \left(\sqrt{\frac{8}{7}}\right)^2}$$

$$= \frac{8 - \frac{8}{7}}{8 + \frac{8}{7}} = \frac{8\left(1 - \frac{1}{7}\right)}{8\left(1 + \frac{1}{7}\right)} = \frac{6}{8} = \frac{3}{4}$$

16. (b)
- $\frac{1 - \cos \alpha + \sin \alpha}{1 + \sin \alpha} =$

$$= \frac{1 - \cos \alpha + \sin \alpha}{1 + \sin \alpha} \cdot \frac{1 + \cos \alpha + \sin \alpha}{1 + \cos \alpha + \sin \alpha}$$

$$= \frac{(1 + \sin \alpha)^2 - \cos^2 \alpha}{(1 + \sin \alpha)(1 + \cos \alpha + \sin \alpha)}$$

$$= \frac{(1 + \sin^2 \alpha + 2 \sin \alpha) - (1 - \sin^2 \alpha)}{(1 + \sin \alpha)(1 + \cos \alpha + \sin \alpha)}$$

$$= \frac{2 \sin \alpha (1 + \sin \alpha)}{(1 + \sin \alpha)(1 + \cos \alpha + \sin \alpha)}$$

$$= \frac{2 \sin \alpha}{1 + \cos \alpha + \sin \alpha} = y$$

17. (c) Given that
- $\theta + \phi = \frac{\pi}{6}$

$$\Rightarrow \tan(\theta + \phi) = \tan \frac{\pi}{6}$$

$$\Rightarrow \frac{\tan \theta + \tan \phi}{1 - \tan \theta \tan \phi} = \frac{1}{\sqrt{3}}$$

$$\Rightarrow \sqrt{3} \tan \theta + \sqrt{3} \tan \phi = 1 - \tan \theta \tan \phi \quad \dots(1)$$

$$(\sqrt{3} + \tan \theta)(\sqrt{3} + \tan \phi)$$

$$= 3 + \sqrt{3} \tan \theta + \sqrt{3} \tan \phi + \tan \theta \tan \phi$$

$$= 3 + 1 - \tan \theta \tan \phi + \tan \theta \tan \phi = 4$$

18. (d)
- $x = 2 - \sqrt{3}$

$$\frac{1}{x} = \frac{1}{2 - \sqrt{3}} \times \frac{2 + \sqrt{3}}{2 + \sqrt{3}} = 2 + \sqrt{3}$$

$$x^2 - \frac{1}{x^2} = \left(x - \frac{1}{x}\right)^2 - 2$$

$$= 2 - \sqrt{3} - 2 + \sqrt{3}^2 - 2$$

$$= 16 - 2 = 14$$

19. (c)
- $a^2 + b^2 + c^2 = 2a - 2b - 2$
-
- $(a^2 - 2a + 1) + (b^2 + 2b + 1) + c^2 = 0$

$$(a - 1)^2 + (b + 1)^2 + c^2 = 0$$

This equation is possible if

$$a - 1 = 0, b + 1 = 0 \text{ and } c = 0$$

$$a = 1, b = -1, c = 0$$

$$3a - 2b + c = 3 \times 1 - 2 \times (-1) + 0$$

$$= 3 + 2 = 5$$

20. (a) Working with the options, for
- $x = 0$
- , the least value of

$$f(x) = 3^x - 3^{-x} - 2$$

Alternate :

$$\text{Let } A = 3^x \text{ and } \frac{1}{A} = 3^{-x}$$

$$\Rightarrow \text{Both are positive.}$$

Now, A.M. of A and $\frac{1}{A}$ is greater than or equal to their G.M.

$$\text{i.e. } \frac{A}{2} \cdot \frac{1}{A} \geq \sqrt{A \cdot \frac{1}{A}}$$

$$\text{or } A \cdot \frac{1}{A} \geq 2$$

$$\text{or } 3^x \cdot 3^{-x} \geq 2.$$

21. (d) Required difference

$$= \left(\frac{19-11}{100} \right) \times 120000 = 9600$$

22. (c) Required percentage

$$= \frac{10200}{120000} \times 100 = 8.5\%$$

23. (d) Estimated cost of furniture and miscellaneous expenditures

$$= \left(\frac{13}{100} + \frac{8}{100} \right) \times 120000 = 25200$$

Actual cost of furniture

$$= \frac{88}{100} \times \frac{13}{100} \times 120000 = 13728$$

Actual cost of furniture and miscellaneous expenditure

$$= 13728 + 10200 = 23928$$

Total expenditure of the family

$$= 120000 - 25200 + 23928 = 118728$$

24. (a) Let the breadth of the rectangular plot be x metre.

$$\therefore \text{Length} = 3x \text{ metre}$$

According to the question,

$$3x \times x = 7803$$

$$\Rightarrow x^2 = \frac{7803}{3} = 2601$$

$$\therefore x = \sqrt{2601} = 51 \text{ metre}$$

25. (d) Internal diameter of the tube = 6 cm

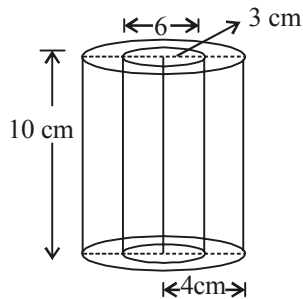

$$\therefore \text{Internal radius } (r) = 3 \text{ cm}$$

$$\text{Height of the tube } (h) = 10 \text{ cm}$$

Thickness of the metal = 1 cm

\therefore Outer radius (R) = Thickness of the metal + Internal radius = 1 + 3 = 4 cm

\therefore Outer curved surface area

$$= 2\pi rh + \pi R^2 + \pi(R^2 - r^2)$$

$$= 2\pi(3)(10) + \pi(4)^2 + \pi(16 - 9)$$

$$= 60\pi + 16\pi + 7\pi = 83\pi \text{ sq cm}$$

26. (d) Given : $0.111 \dots = \frac{1}{9}$

$$0.444 \dots = 4 \times 0.111 \dots$$

$$= 4 \times \frac{1}{9} = \frac{4}{9}$$

27. (a) $x^2 + y^2 = (1 - \sqrt{2})^2 + (1 + \sqrt{2})^2 = 2[(1)^2 + (\sqrt{2})^2]$
 $= 2 \times 3 = 6.$

28. (b) The LCM of 9, 10 and 15 = 90

On dividing 1936 by 90, the remainder = 46

But 7 is also a part of this remainder.

$$\therefore \text{the required number} = 46 - 7 = 39$$

29. (c) Total speed of car, bus and train = $72 \times 3 = 216 \text{ km}$

Speed of car and train

$$= \frac{5}{5} \times \frac{9}{9} \times 216 = 168 \text{ km}$$

$$\text{Average} = \frac{168}{2} = 84 \text{ km}$$

30. (d) C.P. for 1 litchu = $\frac{10}{11}$ paise

$$\text{S. P. for 1 litchu} = \frac{11}{10} \text{ paise}$$

$$\therefore \text{gain \%} = \frac{\frac{11}{10} - \frac{10}{11}}{\frac{10}{11}} \times 100 = 21\%$$

31. (c) Let the first number be x and the second number be y .

According to the question,

$$2x + 3y = 141 \quad \dots(i)$$

$$3x + 2y = 174 \quad \dots(ii)$$

By equation (i) $\times 3 -$ (ii) $\times 2$, we have

$$6x + 9y - 6x - 4y = 423 - 348$$

$$\Rightarrow 5y = 75 \Rightarrow y = \frac{75}{5} = 15$$

From equation (i), $2x + 3 \times 15 = 141$

$$\Rightarrow 2x = 141 - 45 = 96 \Rightarrow x = \frac{96}{2} = 48$$

\therefore Larger number = 48

32. (b) $m_1 \times d_1 \times t_1 \times w_2 = m_2 \times d_2 \times t_2 \times w_1$
 $24 \times 10 \times 8 \times 1 = m_2 \times 6 \times 10 \times 1$
 $\Rightarrow m_2 = \frac{24 \times 10 \times 8}{6 \times 10} = 32 \text{ men}$
33. (d) Let after t hours they meet then,
 $3t + 4t = 17.5 \Rightarrow t = 2.5$
 $\therefore \text{Time} = 10 \text{ am} + 2.5 \text{ h} = 12 : 30 \text{ pm}$
34. (c) Length of wire
 $= 2\pi \times R = \left(2 \times \frac{22}{7} \times 56 \right) \text{ cm} = 352 \text{ cm.}$
 Side of the square $= \frac{352}{4} \text{ cm} = 88 \text{ cm.}$
 Area of the square $= (88 \times 88) \text{ cm}^2 = 7744 \text{ cm}^2.$
35. (c) Let A paid = Rs x
 $125\% \text{ of } 120\% \text{ of } x = 225$
 $\Rightarrow \frac{125}{100} \times \frac{120}{100} \times x = 225$
 $\Rightarrow x = \frac{225 \times 100 \times 100}{125 \times 120} = ₹150$
36. (b) Cistern filled by both pipes in one hour
 $= \frac{1}{14} + \frac{1}{16} = \frac{15}{112} \text{ th}$
 $\therefore \text{Both pipes filled the cistern in } \frac{112}{15} \text{ hrs.}$
 Now, due to leakage both pipes filled the cistern in
 $\frac{112}{15} - \frac{32}{60} = 8 \text{ hrs.}$
 $\therefore \text{Due to leakage, filled part in one hour}$
 $\frac{1}{8}$
 $\therefore \text{part of cistern emptied, due to leakage in one hour}$
 $= \frac{15}{112} - \frac{1}{8} = \frac{1}{112} \text{ th}$
 $\therefore \text{In } 112 \text{ hr, the leakage would empty the cistern.}$
37. (d) Let the usual speed of the plane be $x \text{ km/h}$
 $\therefore \text{Time taken in covering the distance of } 1500 \text{ km}$
 $= \frac{1500}{x} \text{ hours}$
- $\therefore \frac{1500}{x} = \frac{1500}{x} - \frac{1}{2}$
 $\Rightarrow 3000x = 3000(x + 250) - x(x + 250)$
 $\Rightarrow x^2 + 250x - 3000 \times 250 = 0$
 $\Rightarrow x = \frac{-250 \pm \sqrt{62500 + 3000000}}{2}$
 $= \frac{-250 + 1750}{2} = 750 \text{ km/h}$
38. (a) $(2a + 3b)(2c - 3d) = (2a - 3b)(2c + 3d)$
 $\Rightarrow \frac{(2a + 3b)}{(2a - 3b)} = \frac{(2c + 3d)}{(2c - 3d)}$
 $\Rightarrow \frac{2\left(\frac{a}{b}\right) + 1}{2\left(\frac{a}{b}\right) - 1} = \frac{2\left(\frac{c}{d}\right) + 1}{2\left(\frac{c}{d}\right) - 1}$
 $\Rightarrow \frac{a}{b} = \frac{c}{d}$
39. (b) $x = 3 + 2\sqrt{2}$
 $\therefore \frac{1}{x} = \frac{1}{3 + 2\sqrt{2}}$
 $= \frac{1}{3 + 2\sqrt{2}} \times \frac{3 - 2\sqrt{2}}{3 - 2\sqrt{2}} = \frac{3 - 2\sqrt{2}}{9 - 8}$
 $= 3 - 2\sqrt{2}$
 $\therefore \left(\sqrt{x} - \frac{1}{\sqrt{x}} \right)^2 = x - \frac{1}{x} - 2$
 $= 3 + 2\sqrt{2} + 3 - 2\sqrt{2} - 2 = 4$
 $\therefore \sqrt{x} - \frac{1}{\sqrt{x}} = 2$
40. (a) $\sin(x + y) = \cos[3(x + y)]$
 $\cos[90^\circ - (x + y)] = \cos[3(x + y)]$
 $90^\circ - (x + y) = 3(x + y)$
 $4(x + y) = 90^\circ$
 $2(x + y) = 45^\circ$
 $\therefore \tan[2(x + y)] = \tan 45^\circ = 1$
41. (c) TVX : Each letter of the first group is moved five steps forward to obtain the corresponding letter of the second group.
42. (a) A saint practices meditation. While, a scientist does research.

43. (c) The relationship is $x : x(x + 1)$
 44. (d) All except Lord Tennyson were either the Governor-General or the Viceroy of India.
 45. (c) After a close look you will get that except 360 each number is one more than square of a natural number, i.e., $226 = 15^2 + 1$; $290 = 17^2 + 1$; $170 = 13^2 + 1$.
 46. (c) The Pattern is—

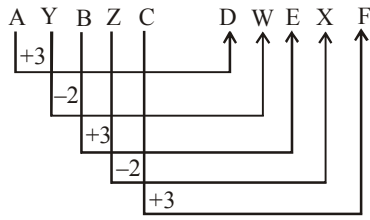

Therefore,

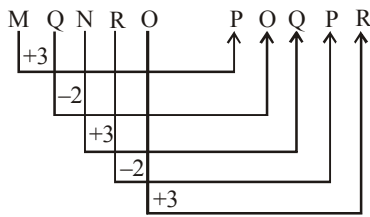

47. (d) $8 \times 2 - 1 = 15$, $15 \times 2 - 2 = 28$, $28 \times 2 - 3 = 53$, $53 \times 2 - 4 = 102$

48. (b)

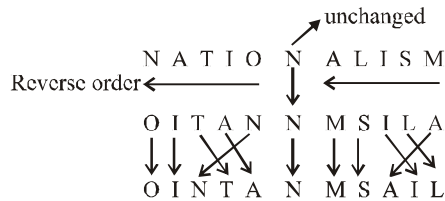

Similarly,

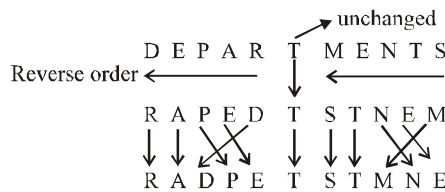

49. (a) The colour of sunflower is yellow and yellow is called 'red'. Hence sunflower is red.
 50. (c) Woman's Mother's husband

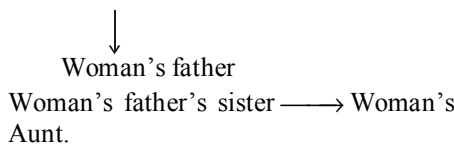

- Since, woman's aunt is man's aunt
 \therefore Woman is sister of man.
 51. (d) The movements of Rasik from A to F are as shown in figure.
 Since $CD = AB + EF$, so F lies in line with A.
 Rasik's distance from original position $A = AF = (AG + GF) = (BC + DE) = (30 + 15)m = 45m$.
 Also, F lies to the east of A.

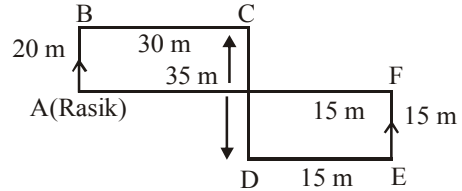

52. (b) There are $(25 - 11 - 1) = 13$ boys between Akash and Nikhil.
 53. (b) $Q > S, P > Q, R > Q$
 Age: As, $Q > S, P > Q, R > Q$
 Also, P is the oldest.
 $\therefore P > R > Q > S$
 Richness: As, $P > Q, S > P$
 Also R is the richest.
 $\therefore R > S > P > Q$

54. (b) Clearly, the given words when arranged in the order of various events as they occur in man's life, term the sequence: Birth - Education - Marriage - Death - Funeral.
 So the correct order becomes 1 5 4 2 3

55. (c) Capsules are different from injection but both are uses as antibiotics.

56. (a) Conclusions I: True
 Conclusions II: False

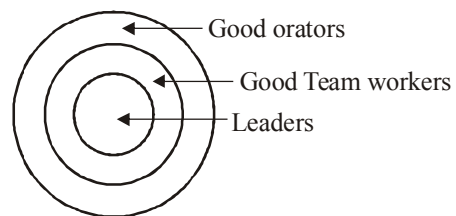

57. (a)

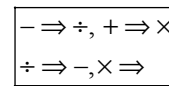

Option (a) : $6 \div 20 \times 12 + 7 - 1 = 70$
 L.H.S. = $6 - 20 + 12 \times 7 \div 1$
 $= 6 - 20 + 84$
 $= 90 - 20 = 70$ R.H.S.

58. (c) $2 \times 7 \times 9 = 126$
 $7 \times 3 \times 8 = 168$
 $9 \times 4 \times x = 216$
 $\Rightarrow x = 6$

59. (b) $4^2 + 1^2 + 2^2 + 3^2 = 30$
 $6^2 + 3^2 + 4^2 + 15 = 286$
 $3^2 + 4^2 + x + 12^2 = 218$
 $169 + x = 218$
 $x = 218 - 169 = \sqrt{49} = 7$

60. (c) When the sheet shown in fig. (X) is folded to form a cube, then the face with shading lies opposite to the free bearing a square, the face bearing a dot lies opposite to a blank face and the face bearing a circle (with a '+' sign inside it) lies opposite to another blank face. The cubes in figures (2) and (4) have the shaded face adjacent to the face bearing a square. Therefore, the cubes in these two figures cannot be formed. Hence, only cubes in figures (1) and (3) can be formed.

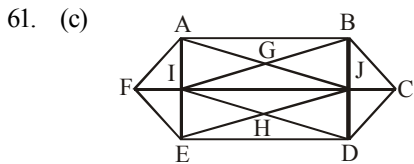

The triangles are:
 ΔFAE ; ΔFAI ; ΔFIE ; ΔCBD ;
 ΔCBJ ; ΔCJD ; ΔAIJ ; ΔBJI ;
 ΔBJA ; ΔAIB ; ΔIED ; ΔJDE ;
 ΔJDI ; ΔIEJ ; ΔGAB ; ΔGAI ;
 ΔGJI ; ΔGJB ; ΔHJI ; ΔHDE ;
 62. (b) ΔHEI ; ΔHJD ; ΔAJF ; ΔEFJ ;
 ΔBCI ; ΔCDI ; ΔIBD ; ΔJEA .

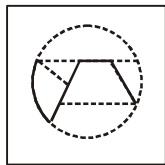

63. (c) Unfolded step I

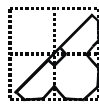

step II

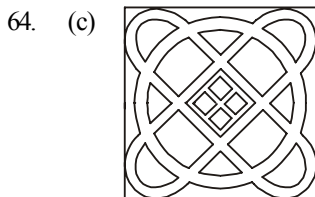
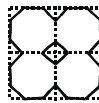

65. (d) DRUK cannot be formed using TRIVANDRUM as it does not contain letter 'K'.

66. (b) Meaningful word \Rightarrow LIP

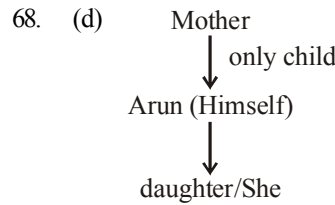
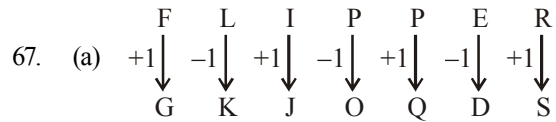

Therefore, the girl is the daughter of Arun.

(69-71):

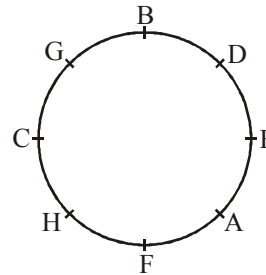

69. (a) D is to the immediate left of B.
 70. (d) B and C are immediate neighbours of G.
 71. (c) C is sitting just opposite to E. F is sitting just opposite to B. Similarly, A is sitting just opposite to G.



Condition (iii) is applicable.

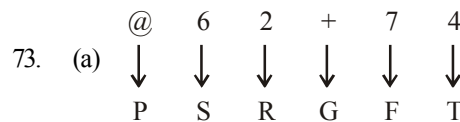

Condition (i) is applicable.

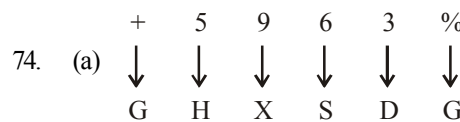

Condition (ii) is applicable.

75. (d)

1	3	4	7	9	2	5	6	8
A	Q	F	J	L	D	M	P	N

Thus,

3	9	6	8	2	4
Q	L	P	N	D	F

76. (d) 4, 45, 453, 4531, 45312, 45, 453, 4531
The next coded digit will be 1. Hence, the instruction Run will come next.

77. (d) The new letter sequence is EDRPSEISNO.
The seventh letter from the right is P.

↪ ↪ ↪ ↪ ↪
D E P R E S S I O N

1 2 3 4 5 6 7 8 9 10
↪ ↪ ↪ ↪ ↪

78. (a) na pa ka so → birds fly very high
ri so la pa → birds are very beautiful
ti me ka bo → the parrots could fly
Thus high is coded as na.

79. (d) 48 Q 12 R 10 P 8 W 4 = ?
⇒ ? = 48 ÷ 12 × 10 - 8 + 4
⇒ ? = 4 × 10 - 8 + 4
⇒ ? = 40 - 8 + 4 = 36

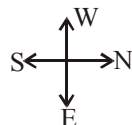
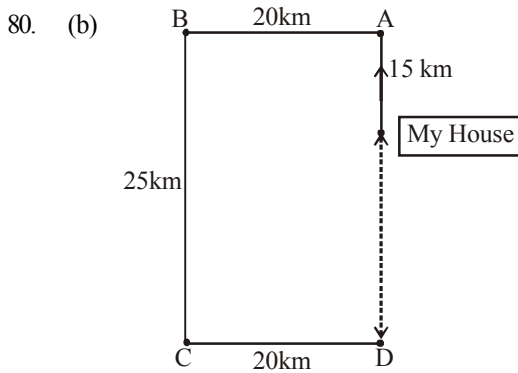

From the above diagram required distance = 25 - 15 = 10 km.

81. (d)
82. (a) Therigatha was a part of the Buddhist literature.
83. (a) 84. (d) 85. (a)

86. (a) Our country is mentioned in the constitution by the name of India and Bharat

87. (c) Per capita Income of a country derived from National Income and population both.

88. (b) NAFED implements the price support scheme (PSS).

89. (c) 'Udyog Bandhu' is a committee to assist industrial units in solving time bound establishment and related problems.

90. (a) Scalars are quantities that have magnitude only; they are independent of direction. Vectors have both magnitude and direction. Momentum is the product of the mass and velocity of an object (p = mv). Momentum is a vector quantity, since it has a direction as well as a magnitude. The rest of quantities in option pressure, work and energy have magnitude but not direction.

91. (a) Washing machine works on the principle of centrifugation. Centrifugation is a process that involves the use of the centrifugal force for the separation of mixtures with a centrifuge, used in industry and in laboratory settings. More-dense components of the mixture migrate away from the axis of the centrifuge, while less-dense components of the mixture migrate towards the axis.

92. (a) Fuel value can be expressed in terms of calorific value of fuel. The calorific value of a fuel is the amount of heat produced by burning 1 kg of fuel. Hydrogen has the highest calorific value of (141,790 KJ/kg) thus have highest fuel value. Calorific value of charcoal, natural gas and gasoline are (29,600; 43,000; 47,300 kJ/kg) respectively. Natural gas majorly consists of methane.

93. (a)
94. (a) Thyroxine hormone and tri-iodothyronine hormone are secreted by thyroid follicular cells of thyroid gland. The major component of thyroxine hormone is iodine. Deficiency of iodine causes goitre in human.

95. (d) The major component of honey is fructose. Composition of honey in (percentage)

Fructose	- 38.2	Sucrose	- 1.5
Glucose	- 31	Minerals	- 0.5
Water	- 17.1		
Maltose	- 7.2		

- Carbohydrate – 4.2
96. (c) Generally blindness is caused by the dryness and hardness of cornea. Cornea is a clear layer which helps passing of light. It is an outer layer and can be transfer from one person to another.
97. (d) Octopus is an animal of class-Cephalopoda and phylum Mollusca. The shell is absent. It is found at bottom of the sea. It kills its prey with poisonous saliva. It can change its colour.
98. (a) 99. (c) 100. (d) 101. (c)
102. (b) The BASIC countries are a bloc of four large developing countries comprises Brazil, South Africa, India and China formed by an agreement on 28 November 2009. The four committed to reduce greenhouse gas emission.
103. (a) 104. (a) 105. (b)
106. (b) 107. (c) 108. (d)
109. (a) 110. (c) 111. (c)
112. (b) 113. (b) 114. (c)
115. (c)
116. (c) Narendra Modi, Prime Minister Narendra Modi will launch Pradhan Mantri Grameen Awas Yojna, an ambitious housing scheme for rural poor, in Agra on November 20, 2016. Mr Modi will also give away the allotment letters to 50 beneficiaries of the scheme that aims to provide about 3 crore new housing units countrywide.
117. (d) New Delhi, A special counter-terror unit of NSG commandos conducted a three-hour-long mock drill at a Delhi Metro station located on the airport express line on November 19, 2016. The mock drill was named 'intervention of rail coaches and countering of terrorist elements'.
118. (a) China, China has launched a 712-km quantum communication line, on November 20, 2016. This quantum communication line is the world's longest secure telecommunications network, with ultra-high security which makes it impossible to tap, intercept or crack the information transmitted through them. The new quantum communication line will connect Hefei, capital of Anhui province, to Shanghai, the China's financial hub.
119. (b) Al Nahyan
120. (b) Ravichandran Ashwin

ARITHMETIC

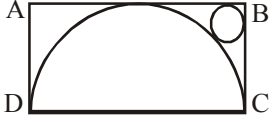
- If $3\frac{4}{5}$ is subtracted from $6\frac{3}{5}$ and difference is multiplied by 355 then what will be the final number?
(a) 1004 (b) 884
(c) 774 (d) 994
- How many times must 79 be subtracted from 5×10^4 so as to obtain 43759?
(a) 77 (b) 78
(c) 79 (d) 80
- In a class of 65 students and 4 teachers, each student got sweets that are 20% of the total number of students and each teacher got sweets that are 40% of the total number of students. How many sweets were there?
(a) 845 (b) 897
(c) 949 (d) 104
- An order was placed for supply of carpet of breadth 3 metres, the length of carpet was 1.44 times of breadth. Subsequently the breadth and length were increased by 25 and 40 per cent respectively. At the rate of ₹45 per square metre, what would be the increase in the cost of the carpet?
(a) ₹1020.6 (b) ₹398.8
(c) ₹437.4 (d) ₹583.2
- In a mixture of milk and water the proportion of water by weight was 75% if in the 60 gms mixture 15 gms water was added, what would be the percentage of water in the new mixture?
(a) 75% (b) 80%
(c) 90% (d) 100%
- The sum of five numbers is 290. The average of the first two numbers is 48.5 and the average of last two numbers is 53.5. What is the third number?
(a) 72 (b) 84
(c) 96 (d) 86
- The average weight of a class of 15 boys and 10 girls is 38.4 kg. If the average weight of the boys is 40 kg, then what is the average weight of the girls?
(a) 36.5 kg (b) 35 kg
(c) 36 kg (d) 34.6 kg
- The angle of elevation of a cloud from a point 200 m above a lake is 30° and the angle of depression of its reflection in the lake is 60° . The height of the cloud is
(a) 200m (b) 300m
(c) 400m (d) 600m
- A and B can finish a work in 10 days while B and C can do it in 18 days. A started the work, worked for 5 days, then B worked for 10 days and the remaining work was finished by C in 15 days. In how many days could C alone have finished the whole work?
(a) 30 days (b) 15 days
(c) 45 days (d) 24 days
- ABCD is a cyclic quadrilateral in which $BC \parallel AD$, $\angle ADC = 110^\circ$ and $\angle BAC = 50^\circ$ find $\angle DAC$
(a) 60° (b) 45°
(c) 90° (d) 120°
- In a triangle ABC, the internal bisector of the angle A meets BC at D. If $AB = 4$, $AC = 3$ and $\angle A = 60^\circ$, then the length of AD is
(a) $2\sqrt{3}$ (b) $\frac{12\sqrt{3}}{7}$
(c) $15\sqrt{\frac{3}{8}}$ (d) $6\sqrt{\frac{3}{7}}$
- The figure shows a rectangle ABCD with a semi-circle and a circle inscribed inside it as shown. What is the ratio of the area of the circle to that of the semi-circle?

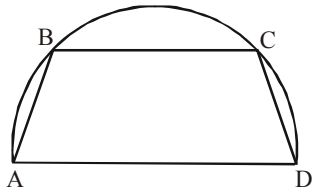
(a) $(\sqrt{2}-1)^2$ (b) $2(\sqrt{2}-1)^2$
(c) $(\sqrt{2}-1)^2/2$ (d) None of these
- On a semicircle with diameter AD, chord BC is parallel to the diameter. Further, each of the chords AB and CD has length 2, while AD has length 8. What is the length of BC?



- (a) 7.5 (b) 7
 (c) 7.75 (d) None of these
14. ABCD is a square, F is the mid-point of AB and E is a point on BC such that BE is one-third of BC. If area of $\Delta FBE = 108 \text{ m}^2$, then the length of AC is:

- (a) 63 m (b) $36\sqrt{2}$ m
 (c) $63\sqrt{2}$ m (d) $72\sqrt{2}$ m

15. If $a^2 = b + c$, $b^2 = c + a$, $c^2 = a + b$, then the value

of $\frac{1}{1+a} + \frac{1}{1+b} + \frac{1}{1+c}$

- (a) abc (b) $a^2 b^2 c^2$
 (c) 1 (d) 0

16. If $x + \frac{1}{y} = 1$ and $y + \frac{1}{z} = 1$, what is the value of xyz ?

- (a) 1 (b) -1
 (c) 0 (d) $\frac{1}{2}$

17. If $p = 999$, then the value of

$\sqrt[3]{p(p^2 - 3p - 3) + 1}$ is

- (a) 1000 (b) 999
 (c) 998 (d) 1002

18. If θ is an acute angle such that $\tan^2 \theta = \frac{8}{7}$, then

the value of $\frac{1 + \sin \theta}{1 + \cos \theta} \cdot \frac{1 - \sin \theta}{1 - \cos \theta}$ is

- (a) $\frac{7}{8}$ (b) $\frac{8}{7}$
 (c) $\frac{7}{4}$ (d) $\frac{64}{49}$

19. If $3 \cos \theta = 5 \sin \theta$, then the value of

$\frac{5 \sin \theta - 2 \sec^3 \theta + 2 \cos \theta}{5 \sin \theta + 2 \sec^3 \theta - 2 \cos \theta}$ is equal to

- (a) $\frac{271}{979}$ (b) $\frac{376}{2937}$
 (c) $\frac{542}{2937}$ (d) None of these

20. If $a \cos \theta - b \sin \theta = c$, then $a \cos \theta + b \sin \theta = ?$

- (a) $\sqrt{a^2 - b^2 - c^2}$ (b) $\sqrt{a^2 + b^2 - c^2}$
 (c) $\pm \sqrt{c^2 - a^2 - b^2}$ (d) None of these

DIRECTIONS (Qs. 21-23) : Study the following graph carefully to answer these questions.

Quantity of various items sold and price per kg.

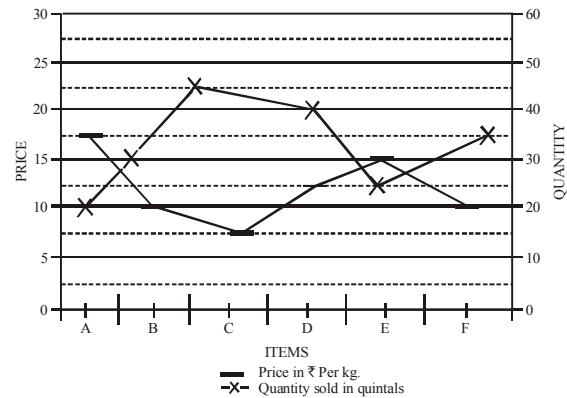

21. If the quantity sold of item D increased by 50% and the price reduced by 10%, what was the total value of the quantity sold for Item D?

- (a) ₹ 675 (b) ₹ 6750
 (c) ₹ 67550 (d) ₹ 67500

22. Approximately, what is the average price per kg of items A, B and C?

- (a) ₹ 9.50 (b) ₹ 8
 (c) ₹ 7.50 (d) ₹ 11.6

23. What is the ratio between the total values of quantity sold for items E and F respectively?

- (a) 15 : 14 (b) 3 : 2
 (c) 5 : 7 (d) 7 : 5

24. From the top of a cliff 200 m high, the angles of depression of the top and bottom of a tower are observed to be 30° and 45° , respectively. What is the height of the tower?

- (a) 400 m (b) $400\sqrt{3}$ m
 (c) $400/\sqrt{3}$ m (d) None of these

25. For a plot of land of $100 \text{ m} \times 80 \text{ m}$, the length to be raised by spreading the earth from stack of a rectangular base $10 \text{ m} \times 8 \text{ m}$ and vertical section being a trapezium of height 2 m . The top of the stack is $8 \text{ m} \times 5 \text{ m}$. How many centimeters can the level raised?
 (a) 3 cm (b) 2.5 m
 (c) 2 cm (d) 1.5 cm
26. The divisor is 25 times the quotient and 5 times the remainder. If the quotient is 16, the dividend is:
 (a) 6400 (b) 6480
 (c) 400 (d) 480
27. Find the greatest number of five digits which is a perfect square.
 (a) 99683 (b) 99999
 (c) 99856 (d) 99865
28. What greatest number can be subtracted from 10,000 so that the remainder may be divisible by 32, 36, 48 and 54?
 (a) 9136 (b) 9191
 (c) 9933 (d) 9216
29. The average marks in Science subject of a class of 20 students is 68. If the marks of two students were misread as 48 and 65 of the actual marks 72 and 61 respectively, then what would be the correct average?
 (a) 68.5 (b) 69
 (c) 69.5 (d) 70
30. A shopkeeper's price is 50% above the cost price. If he allows his customer a discount of 30% what profit does he make?
 (a) 5% (b) 10%
 (c) 15% (d) 20%
31. Populations of two villages X and Y are in the ratio of 5 : 7 respectively. If the population of village Y increases by 25000 and the population of village X remains unchanged the respective ratio of their populations becomes 25 : 36. What is the population of village X?
 (a) 6,25,000 (b) 6,75,000
 (c) 8,75,000 (d) 9,00,000
32. If 15 women or 10 men can complete a project in 55 days, in how many days will 5 women and 4 men working together complete the same project?
 (a) 75 (b) 8
 (c) 9 (d) 85
33. A goods train leaves a station at a certain time and at a fixed speed. After 6 hours, an express train leaves the same station and moves in the same direction at a uniform speed of 90 kmph. This train catches up the goods train in 4 hours. Find the speed of the goods train.
 (a) 36 kmph (b) 40 kmph
 (c) 30 kmph (d) 42 kmph
34. A metal cube of edge 12 cm is melted and formed into three smaller cubes. If the edges of two smaller cubes are 6 cm and 8 cm, then find the edge of the third smaller cube.
 (a) 10 cm (b) 14 cm
 (c) 12 cm (d) 16 cm
35. A shopkeeper buys 50 dozen eggs at ₹ 4 per dozen. Out of them, 40 eggs were found broken. At what rate should he sell the remaining eggs per dozen so as to gain 5% on the whole?
 (a) ₹ 4 (b) ₹ 4.25
 (c) ₹ 4.50 (d) ₹ 5.25
36. Three fill pipes A, B and C can fill separately a cistern in 3, 4 and 6 minutes respectively. A was opened first. After 1 minute, B was opened and after 2 minutes from the start of A, C was also opened. Find the time when the cistern will be full?
 (a) $2\frac{1}{9}$ min (b) $4\frac{1}{2}$ min
 (c) $3\frac{3}{4}$ min (d) None of these
37. A train 108 m long moving at a speed of 50 km/h crosses a train 112 m long coming from the opposite direction in 6 seconds. The speed of the second train is
 (a) 48 km/h (b) 54 km/h
 (c) 66 km/h (d) 82 km/h
38. If $y : x = 4 : 15$, then the value of $\left(\frac{x-y}{x+y}\right)$ is
 (a) $\frac{11}{19}$ (b) $\frac{19}{11}$
 (c) $\frac{4}{11}$ (d) $\frac{15}{19}$
39. If $x + \frac{1}{4x} = \frac{3}{2}$, find the value of $8x^3 + \frac{1}{8x^3}$.
 (a) 18 (b) 36
 (c) 24 (d) 16
40. If $\tan \theta = -\frac{1}{\sqrt{7}}$, then $\frac{\operatorname{cosec}^2 \theta - \sec^2 \theta}{\operatorname{cosec}^2 \theta + \sec^2 \theta} = ?$
 (a) $-\frac{3}{4}$ (b) $-\frac{2}{3}$
 (c) $\frac{2}{3}$ (d) $\frac{3}{4}$

GENERAL INTELLIGENCE & REASONING

41. 'Hygrometer' is related to 'Humidity' in the same way as 'Sphygmomanometer' is related to
 (a) Pressure (b) Blood Pressure
 (c) Precipitation (d) Heart Beat
42. HEATER : KBDQHO :: COOLER : ?
 (a) ALRHV (b) FLRIHO
 (c) FLIRHO (d) FRLIHO
43. 12 : 30 :: 20 : ?
 (a) 25 (b) 32
 (c) 35 (d) 42

DIRECTIONS (Qs. 44 to 45) : Find the odd word/ letters/number pair from the given alternatives.

44. (a) Microbe (b) Microflim
 (c) Microphone (d) Microscope
45. (a) BDGK (b) JLOS
 (c) HJMQ (d) MORU

DIRECTIONS (Qs. 46 - 47) : Complete the given series.

46. YEB, WFD, UHG, SKI, (?)
 (a) QOL (b) TOL
 (c) QGL (d) QNL
47. 2 12 36 80 150 ?
 (a) 194 (b) 210
 (c) 252 (d) 258
48. In a certain code language OUTCOME is written as OQWWEQOE. How is REFRACT written in that code?
 (a) RTGTCET (b) RGTICET
 (c) RTGITECT (d) RGTICTET
49. If A = 1, PAT = 37 then TAP = ?
 (a) 73 (b) 37
 (c) 36 (d) 38
50. Introducing Rajesh, Neha said, "His brother's father is the only son of my grand father". How Neha is related to Rajesh?
 (a) Sister (b) Daughter
 (c) Mother (d) Niece
51. Ruchi's house is to the right of Vani's house at a distance of 20 metres in the same row facing North. Shabana's house is in the North-East direction of Vani's house at a distance of 25 metres. Determine that Ruchi's house is in which direction with respect of Shabana's house?
 (a) North-East (b) East
 (c) South (d) West

52. If the positions of the first and the fifth digits of the number 83721569 are interchanged, similarly, the positions of the second and the sixth digits are interchanged, and so on, which of the following will be the third from the right end after the rearrangement?
 (a) 6 (b) 3
 (c) 2 (d) 7
53. Some boys are sitting in a line. Mahendra is on 17th place from left and Surendra is on 18th place from right. There are 8 boys in between them. How many boys are there in the line?
 (a) 43 (b) 42
 (c) 41 (d) 44

DIRECTIONS (Qs. 54-55): In the following questions find the missing number

54.

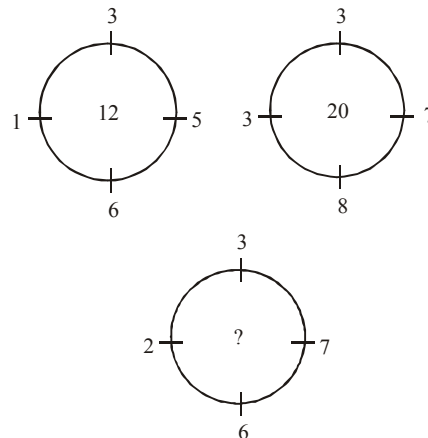

- (a) 10 (b) 15
 (c) 20 (d) 25

55.

21	24	36
11	14	12
3	?	4
77	112	108

- (a) 2 (b) 4
 (c) 3 (d) 5

DIRECTIONS (Q. 56): Arrange the following in a logical order:

56. 1. Millenium 2. Diamond Jubilee
 3. Silver Jubilee 4. Centenary
 5. Golden Jubilee
 (a) 2, 3, 5, 4, 1 (b) 2, 5, 3, 1, 4
 (c) 3, 5, 2, 4, 1 (d) 2, 3, 5, 1, 4

DIRECTIONS (Q. 57) : In the following questions, a group of letters is given which are numbered 1, 2, 3, 4, 5 and 6. Below are given four alternatives containing combinations of these numbers. Select that combination of numbers so that letters arranged accordingly form a meaningful word.

57. INLASG
1 2 3 4 5 6

- (a) 6, 1, 3, 5, 4, 2 (b) 5, 1, 6, 2, 4, 3
(c) 3, 4, 6, 1, 2, 5 (d) 2, 4, 3, 6, 1, 5

58. In the following venn diagram identify the letter which denotes players who are also doctors but not artist.

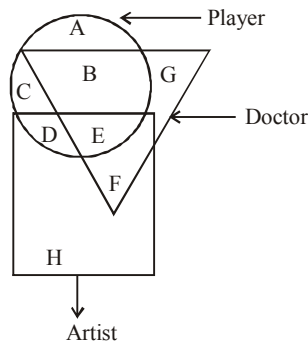

- (a) B + E (b) E
(c) B (d) A

DIRECTIONS (Q. 59) : In question the belows is given two statements followed by two conclusions. You have to take the given statements to be true even if they seem to be at variance with commonly known facts. Read all the conclusions and then decide which of the given statements disregarding commonly known facts. Given Answer:

- Give answer (a)** If only conclusion I follows.
Give answer (b) if only conclusion II follows.
Give answer (c) if either I or II follows.
Give answer (d) if neither I nor II follows.

59. **Statements:**

- All terrorists are human.
All humans are bad.

Conclusions:

- I** All terrorists are bad.
II No human can be a terrorist.

60. Which one of the following is correct?

- $6 * 4 * 9 * 15$
(a) $\times, =, -$ (b) $\times, -, =$
(c) $=, \times, -$ (d) $-, \times, =$

61. If '-' stands for '+', '+' stands for '×', '×' stands for '÷' then which one of the following is not correct?
(a) $22 + 7 - 3 \times 9 = 148$ (b) $33 \times 5 - 10 + 20 = 228$
(c) $7 + 28 - 3 \times 52 = 127$ (d) $44 - 9 + 6 \times 11 = 87$
62. The four different positions of a dice are given below: Find the number on the face opposite the face showing 6?

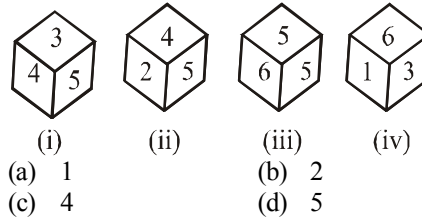

DIRECTIONS (Q. 63) : Which answer figure will complete the pattern in the question figure?

- 63.
- (a) (b)
(c) (d)

64. How many triangles are there in the given figure?

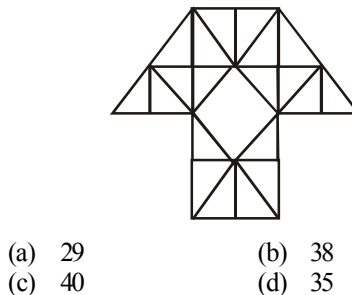

DIRECTIONS (Qs. 65) : In the following question a set of three figures A, B and C showing a sequence of folding of a piece of paper. Fig. (C) shows the manner in which the folded paper has been cut. These three figures are followed by four answer figures from which you have to choose a figure which would most closely resemble the unfolded form of fig. (C).

65.

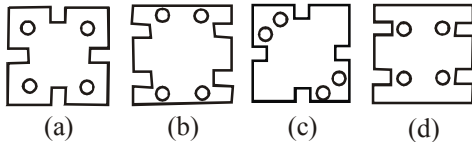
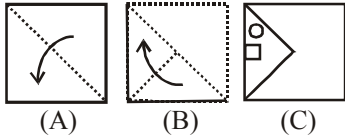

66. If 'yellow' means 'green', 'green' means 'white', white means 'red', 'red' means 'black', 'black' means 'blue' and 'blue' means 'violet', which of the following represents the colour of human blood ?

- (a) black (b) violet
(c) red (d) None of these

67. A trader in order to code the prices of article used the letters of PSICHOAZY in the form of '0 to 9' respectively. Which of the following code stands for ₹ 875.50 ?

- (a) AIL.HP (b) AIL.HS
(c) ZYA.HO (d) None of these

DIRECTIONS (Qs. 68-69) : Study the information given below and answer the questions following it:

Mohan is son of Arun's father's sister. Prakash is son of Reva, who is mother of Vikash and grandmother of Arun. Pranab is father of Neela and grandfather of Mohan. Reva is wife of Pranab.

68. How is Mohan related to Reva ?
(a) Grandson (b) Son
(c) Nephew (d) Data inadequate
69. How is Vikash's wife related to Neela ?
(a) Sister (b) Niece
(c) Sister-in-law (d) Data inadequate

DIRECTIONS (Qs. 70-72) : Study the following information carefully and answer the given questions.

If A + B means A is the father of B
If A × B means A is the sister of B
If A \$ B means A is the wife of B
If A % B means A is the mother of B
If A ÷ B means A is the son of B

70. What should come in place of the question mark, to establish that J is the brother of T in the expression?

- $J \div P \% H ? T \% L$
(a) × (b) ÷
(c) \$ (d) Either ÷ or ×

71. Which among the given expressions indicate that M is the daughter of D?

- (a) $L \% R \$ D + T \times M$
(b) $L + R \$ D + M \times T$
(c) $L \% R \% D + T \div M$
(d) $D + L \$ R + M \times T$

72. Which among the following options is true if the expression 'I + T % J × L ÷ K' is **definitely true**?

- (a) L is the daughter of T
(b) K is the son-in-law of I
(c) I is the grandmother of L
(d) T is the father of L

73. Nishu starting from a fixed point goes 15 km towards North and then after turning to his right he goes 15 km. Then he goes 10, 15 and 15 metres after turning to his left each time. How far is he from his starting point?

- (a) 5 metres (b) 10 metres
(c) 20 metres (d) 15 metres

74. In a class of 90, where girls are twice that of boys, Shridar ranked fourteenth from the top, if there are 10 girls ahead of Shridar, how many boys are after him in rank?

- (a) 23 (b) 26
(c) 25 (d) 22

DIRECTIONS (Qs. 75-76) : These questions are based on the following information.

Six students P, Q, R, S, T and V are the top six rankers of the class. No two persons got the same rank. The student who got the highest marks is given rank 1 and the student who got the least marks is given rank 6. Q got less marks than both R and U. P got more marks than T but less than S. Q got the second least rank and U got the second highest rank, R got less marks than P.

75. _____ got the 3rd rank.
(a) S (b) P
(c) R (d) T
76. _____ got the 6th rank.
(a) T (b) P
(c) R (d) S

77. In a certain code, a number 13479 is written as AQFJL and 2568 is written as DMPN. How is 396824 written in that code?

- (a) QLPNMJ (b) QLPNMF
(c) QLPMNF (d) QLPNDE

DIRECTIONS (Qs. 78-80) : Study the following information to answer the given questions:

In a certain code, 'he was singing good' is written as 'la pa ho ta', 'good was the aim' is written as 'zo ho ji la', 'singing at the stadium' is written as 'ma ta ku ji' and 'was this a stadium' is written as 'ku bi ho vi'.

78. Which of the following represents 'the aim stadium'?
- (a) ma pa ji (b) ku zo pa
(c) ku ji zo (d) ji zo ma
79. Which of the following may be the code for 'she was singing'?
- (a) ro ta zo (b) ta ji ku
(c) ho bo ji (d) ho ta bo
80. What is the code for 'at'?
- (a) ku (b) ji
(c) ma (d) zo
- GENERAL AWARENESS**
81. Ashtapradhan was a council of ministers:
- (a) in the Gupta administration
(b) in the Chola administration
(c) in the Vijayanagar administration
(d) in the Maratha administration
82. Which one among the following newspapers was published first?
- (a) The Madras Mail
(b) The Indian Social Reformer
(c) The Bengal Gazette
(d) The Times of India
83. Jiatrang Movement started in
- (a) Nagaland (b) Tripura
(c) Manipur (d) Mizoram
84. Which term is not used in the preamble of the Indian constitution ?
- (a) Republic (b) Integrity
(c) Federal (d) Socialist
85. The Prime Minister of India is the head of the
- (a) State Government
(b) Central Government
(c) Both the State and Central Government
(d) None of them
86. How many types of writs can be issued by the supreme court?
- (a) 2 (b) 3
(c) 5 (d) 6
87. The Indian Economy is characterised by
- (a) pre-dominance of agriculture
(b) low per capita income
(c) Massive unemployment
(d) All of the above
88. The Green Revolution in India has contributed to
- (a) inter-regional inequality
(b) inter-class inequality
(c) inter-crop inequality
(d) all of the above
89. Core industries include
- (a) basic industries
(b) industries catering to defence requirements
(c) critical industries
(d) all the above
90. Which zone of a candle flame is the hottest ?
- (a) Dark innermost zone
(b) Outermost zone
(c) Middle luminous zone
(d) Central zone
91. Which one of the following is used to remove Astigmatism for a human eye?
- (a) Concave lens (b) Convex lens
(c) Cylindrical lens (d) Prismatic lens
92. Which one of the following is a mixed fertilizer?
- (a) Urea
(b) CAN
(c) Ammonium sulphate
(d) NPK
93. The most reactive among the halogens is
- (a) Fluorine (b) Chlorine
(c) Bromine (d) Iodine
94. Which one of the following is a modified stem?
- (a) Carrot (b) Sweet potato
(c) Coconut (d) Potato
95. 'Athlete's Foot' is a disease caused by
- (a) Bacteria (b) Fungus
(c) Protozoan (d) Nematode
96. Which one of the following is present in chlorophyll which gives a green colour to plant leaves?
- (a) Calcium (b) Magnesium
(c) Iron (d) Manganese
97. In human beings, the opening of the stomach into the small intestine is called
- (a) caecum (b) ileum
(c) oesophagus (d) pylorus
98. Which of the dance forms enlisted in UNESCO?
- (a) Mudiyltu (b) Bidesia
(c) Maach (d) Yakshagan
99. 'India of our Dreams' is a book written by
- (a) Dr. S. Radhakrishnan
(b) Dr. C. Subramanian
(c) M.V. Kamath
(d) Dr. Rajendra Prasad
100. With which game is 'Bully' associated ?
- (a) Cricket (b) Football
(c) Golf (d) Hockey
101. Which amongst the following Abbreviations stands for organization related to Indian space programme?
- (a) NASA (b) ISO
(c) ISRO (d) NSAT

102. Indian Standard Time relates to
(a) 75.5° E longitude (b) 82.5° E longitude
(c) 90.5° E longitude (d) 0° longitude
103. In which Eco-system Grassland is included ?
(a) Marine (b) Fresh water
(c) Terrestrial (d) Artificial
104. US embassy launched a scholarship program for women of which country ?
(a) Myanmar (b) Afghanistan
(c) Sri Lanka (d) Bangladesh
105. What was the theme for the 10th National Statistics Day that was celebrated in June 2016.
(a) Social Development
(b) Agriculture and Farmers' Welfare
(c) Better Data, Better Lives
(d) Statistics for all, with all
106. What is a file?
(a) A file is a section of main storage used to store data
(b) A file is a collection of information that has been given a name and is stored in secondary memory
(c) A file is the part of a program that is used to describe what the program should do
(d) A file is another name for floppy disk
107. The key and the key can be used in combination with other keys to perform shortcuts and special tasks.
(a) Control, Alt
(b) Function, toggle
(c) Delete, Insert
(d) Caps Lock, Num Lock
108. How is it possible that both programs and data can be stored on the same floppy disk?
(a) A floppy disk has two sides, one for data and one for programs
(b) Programs and data are both software, and both can be stored on any memory device
(c) A floppy disk has to be formatted for one or for the other
(d) Floppy disks can only store data, not programs
109. The primary output device for computers is a
(a) video monitor (b) printer
(c) keyboard (d) mouse
110. The name of the location of a particular piece of data is its
(a) address (b) memory name
(c) storage site (d) data location
111. A platform surrounded by rail lines from all the four sides, is called
(a) dock platform
(b) passenger platform
(c) island platform
(d) goods platform
112. Indian Railways Nationalised in which year ?
(a) 1952 (b) 1950
(c) 1951 (d) 1954
113. In which year Research, Design and Standard organization was established?
(a) 1953 (b) 1957
(c) 1956 (d) 1967
114. Railway Staff College is situated at
(a) Mumbai (b) Secundrabad
(c) Ahmedabad (d) Vadodara
115. Where is the Research, Design and Standard Organisation situated?
(a) Lucknow (b) Bangalore
(c) Agra (d) Pune
116. Who has been appointed as National Security Adviser (NSA) by Donald Trump ?
(a) Robert Cutler (b) Gordon Gray
(c) Michael Flynn (d) Susan Rice
117. What is the currency of Cyprus?
(a) Euro (b) Dollar
(c) Dinar (d) Peso
118. Supreme Court has banned Jallikattu, which is a sports related to taming of which animal?
(a) Bull (b) Lion
(c) Buffalo (d) Elephant
119. Which NASA Astronaut has recently become the oldest woman to travel in the Space
(a) Ellen Baker (b) Mary Cleave
(c) Anna Fisher (d) Peggy Whitson
120. Who is the Minister of Petroleum and Natural Gas?
(a) Dr. Jitendra Singh
(b) Dharmendra Pradhan
(c) Chaudhary Birender Singh
(d) Anant Geete

Hints & Explanations

1. (d) Required number

$$\begin{aligned}
 &= \left(6\frac{3}{5} - 3\frac{4}{5}\right) \times 355 \\
 &= \left(\frac{33}{5} - \frac{19}{5}\right) \times 355 \\
 &= \frac{14}{5} \times 355 = 994
 \end{aligned}$$

2. (c) Let
- x
- be the number of times, then
-
- $79x + 43759 = 50,000$

$$\Rightarrow x = (50000 - 43759) \div 79 = \frac{6241}{79} = 79$$

3. (c) Total number of sweets

$$\begin{aligned}
 &= 65 \times 65 \times \frac{20}{100} + 4 \times 65 \times \frac{40}{100} \\
 &= 845 + 104 = 949
 \end{aligned}$$

4. (c) Initial area of the carpet

$$\begin{aligned}
 &= 3 \times (3 \times 1.44) \text{ sq. metre} \\
 &= 12.96 \text{ sq. metre}
 \end{aligned}$$

After corresponding changes in dimensions,
Area of the carpet

$$\begin{aligned}
 &= \left(3 \times \frac{125}{100}\right) \times \left(3 \times 1.44 \times \frac{140}{100}\right) \\
 &= 22.68 \text{ sq. metre} \\
 \therefore \text{Increase in area} \\
 &= (22.68 - 12.96) \text{ sq. metre} \\
 &= 9.72 \text{ sq. metre} \\
 \therefore \text{Increase in the cost} \\
 &= ₹ (9.72 \times 45) = ₹ 437.4
 \end{aligned}$$

5. (b) In 60 gm. of mixture,
-
- Quantity of water

$$= 60 \times \frac{75}{100} = 45 \text{ gm}$$

Quantity of milk = 15 gm

After mixing 15 gm of more water, Quantity
of water in new mixture

$$= 45 + 15 = 60 \text{ gm}$$

\therefore Quantity of water in 75 gm of mixture = 60 gm

\therefore 100 gm of mixture will contain

$$= \frac{60}{75} \times 100 = 80\% \text{ of water}$$

6. (d) Third number

$$\begin{aligned}
 &= 290 - 2 \times 48.5 - 2 \times 53.5 \\
 &= 290 - 97 - 107 = 86
 \end{aligned}$$

7. (c) Let average weight of girls =
- x

$$\begin{aligned}
 \text{Total weight of the boys} &= 40 \text{ kg} \times 15 \\
 &= 600 \text{ kg.}
 \end{aligned}$$

Average weight

$$= \frac{\text{Total weight of girls} + \text{Total weight of boys}}{\text{No. of boys} + \text{No. of girls}}$$

$$\Rightarrow 38.4 = \frac{600 + 10 \times x}{15 + 10}$$

$$\Rightarrow 38.4 = \frac{600 + 10x}{25}$$

$$\Rightarrow 38.4 \times 25 = 600 + 10x$$

$$\therefore x = 36 \text{ kg}$$

8. (c)

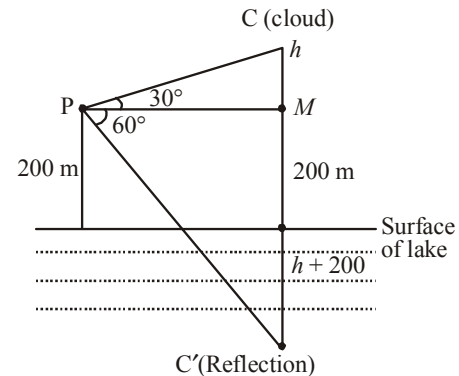

$$\tan 30^\circ = \frac{h}{PM} \Rightarrow PM = \sqrt{3}h$$

$$\tan 60^\circ = \frac{h + 400}{PM} \Rightarrow PM = \frac{h + 400}{\sqrt{3}}$$

$$\sqrt{3}h \cdot \frac{h + 400}{\sqrt{3}} = 3h - h = 400$$

$$\Rightarrow 2h = 400$$

$$\Rightarrow \text{So, height of the cloud} = 200 + 200 = 400 \text{ m}$$

9. (c) Let C completes the work in
- x
- days.

$$\text{Work done by (A + B) in 1 day} = \frac{1}{10}$$

Work done by (B + C) in 1 day = $\frac{1}{18}$

A's 5 days' work + B's 10 days' work + C's 15 days' work = 1

or (A + B)'s 5 days' work + (B + C)'s 5 days' work + C's 10 days' work = 1

or $\frac{5}{10} + \frac{5}{18} + \frac{10}{x} = 1$ or $x = 45$ days

10. (a) $\angle ABC + \angle ADC = 180^\circ$ (sum of opposite angles of cyclic quadrilateral is 180°)

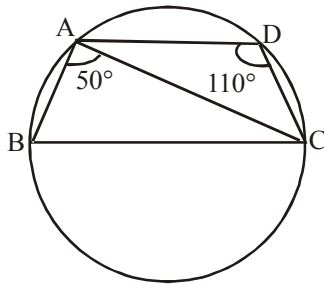

$\Rightarrow \angle ABC + 110^\circ = 180^\circ$
 (ABCD is a cyclic quadrilateral)
 $\Rightarrow \angle ABC = 180 - 110 \Rightarrow \angle ABC = 70^\circ$

($\because AD \parallel BC$)
 $\therefore \angle ABC + \angle BAD = 180^\circ$ (Sum of the interior angles on the same side of transversal is 180°)

$70^\circ + \angle BAD = 180^\circ$
 $\Rightarrow \angle BAD = 180^\circ - 70^\circ = 110^\circ$
 $\Rightarrow \angle BAC + \angle DAC = 110^\circ$
 $\Rightarrow 50^\circ + \angle DAC = 110^\circ$
 $\Rightarrow \angle DAC = 110^\circ - 50^\circ = 60^\circ$

11. (b)

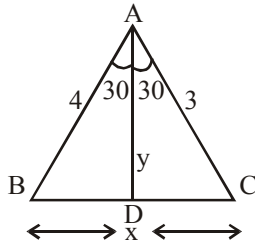

Using the theorem of angle of bisector,

$\frac{BD}{DC} = \frac{AB}{AC} = \frac{4}{3}$
 $\Rightarrow BD = \frac{4}{7}x$ & $DC = \frac{3}{7}x$

In $\triangle ABD$, by sine rule, $\frac{\sin 30}{4/7x} = \frac{\sin B}{y}$... (i)

In $\triangle ABC$, by sine rule; $\frac{\sin 60}{x} = \frac{\sin B}{3}$

or $\frac{\sqrt{3}}{2x} = \frac{\sin 30 \cdot y}{4/7x \times 3}$

[putting the value of $\sin B$ from (i)]

$\Rightarrow y = \frac{\sqrt{3}}{2x} \times \frac{4}{7} \times x \times 3 \times \frac{2}{1} = \frac{12\sqrt{3}}{7}$

12. (c) Let the radius of the semicircle be R .
 Now join O to B

$OC = OD = R \quad \therefore OB = R\sqrt{2}$

The diameter of the smaller circle

$= (R\sqrt{2} - R) = R(\sqrt{2} - 1)$

Area of the semicircle = $\frac{\pi R^2}{2}$;

Area of the circle = $\frac{\pi R^2 (\sqrt{2} - 1)^2}{2^2}$

Hence the ratio of the area of the smaller

circle to that of the semicircle = $\frac{(\sqrt{2} - 1)^2}{2}$

or $(\sqrt{2} - 1)^2 : 2$

13. (b)

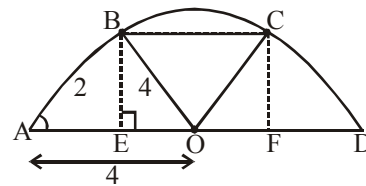

$BO = \text{radius} = 4 = AO$

$AE = 2 \cos A = 2 \times \left(\frac{2^2 + 4^2 - 4^2}{2 \times 2 \times 4} \right) = \frac{2}{4} = \frac{1}{2}$

$\therefore BC = AD - AE - FD = 8 - \frac{1}{2} - \frac{1}{2} = 7$
 ($\because AE = FD$)

14. (b) Let the side of the square be x , then

$BE = \frac{x}{3}$ and $BF = \frac{x}{2}$

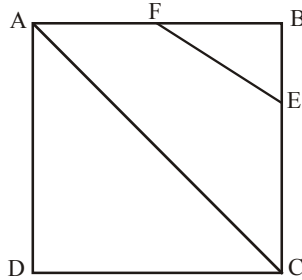

Area of $\triangle FEB = \frac{1}{2} \times \frac{x}{3} \times \frac{x}{2} = \frac{x^2}{12}$

Now, $\frac{x^2}{12} = 108$

$\Rightarrow x^2 = 108 \times 12 = 1296$

In $\triangle ADC$, we have

$AC^2 = AD^2 + DC^2$

$= x^2 + x^2 = 2x^2$

$= 2 \times 1296 = 2592$

or $AC = \sqrt{2592} = 36\sqrt{2}$

15. (c) $\frac{1}{1+a} + \frac{1}{1+b} + \frac{1}{1+c}$

Given that,

$a^2 = b + c$

$a + a^2 = a + b + c$

$a(a+1) = a + b + c$

$a+1 = \frac{a+b+c}{a}$

$\frac{1}{a+1} = \frac{a}{a+b+c}$

Similarly,

$\frac{1}{b+1} = \frac{b}{a+b+c}$

$\frac{1}{c+1} = \frac{c}{a+b+c}$

Put in eq. (i)

$\therefore \frac{a}{a+b+c} + \frac{b}{a+b+c} + \frac{c}{a+b+c}$

$= \frac{a+b+c}{a+b+c} = 1$

16. (b) Given that, $x + \frac{1}{y} = 1$

$\Rightarrow xy + 1 = y$... (i)

and $y + \frac{1}{z} = 1$

$\Rightarrow 1 - \frac{1}{z} = y$

$\Rightarrow \frac{z-1}{z} = y$... (ii)

From eq. (ii),

$y = \frac{z-1}{z}$

Comparing eqn. (i) with (ii)

$xy + 1 = \frac{z-1}{z}$

$\Rightarrow xyz + z = z - 1$

$\Rightarrow xyz = -1$

17. (a) $p = 999$ (Given)

Expression $\Rightarrow \sqrt[3]{p^3 - 3p^2 - 3p + 1}$

$\Rightarrow \sqrt[3]{(p-1)^3}$

$\Rightarrow p-1 = 999-1 = 1000$

... (i)

18. (a) $\frac{1+\sin\theta}{1+\cos\theta} \cdot \frac{1-\sin\theta}{1-\cos\theta} \cdot \frac{1-\sin^2\theta}{1-\cos^2\theta}$

$= \frac{\cos^2\theta}{\sin^2\theta} = \frac{1}{\tan^2\theta} = \frac{1}{\frac{8}{7}} = \frac{7}{8}$

19. (a) Given, $3 \cos \theta = 5 \sin \theta \Rightarrow \tan \theta = \frac{3}{5}$.

$\sec \theta = \sqrt{1 + \tan^2 \theta} = \sqrt{1 + \left(\frac{3}{5}\right)^2}$

$= \sqrt{\frac{25+9}{25}} = \frac{\sqrt{34}}{5}$

In expression, dividing the numerator & denominator by $\cos \theta$,

$= \frac{5 \tan \theta - 2 \sec^4 \theta - 2}{5 \tan \theta + 2 \sec^4 \theta - 2}$

$= \frac{5 \times \frac{3}{5} - 2 \times \left(\frac{\sqrt{34}}{5}\right)^4 - 2}{5 \times \frac{3}{5} + 2 \times \left(\frac{\sqrt{34}}{5}\right)^4 - 2}$

$= \frac{3 - 2 \times \frac{34^2}{625} - 2}{3 + 2 \times \frac{34^2}{625} - 2}$

$$\begin{aligned} &= \frac{3 - 2 \times \frac{1156}{625} - 2}{3 + 2 \times \frac{1156}{625} - 2} = \frac{5 - \frac{2312}{625}}{1 - \frac{2312}{625}} \\ &= \frac{813}{2937} = \frac{271}{979} \end{aligned}$$

20. (b) $(a \cos \theta - b \sin \theta)^2 + (a \cos \theta + b \sin \theta)^2$
 $= a^2 \cos^2 \theta + b^2 \sin^2 \theta - 2ab \sin \theta \cos \theta + a^2 \cos^2 \theta + b^2 \sin^2 \theta + 2ab \cos \theta \sin \theta$
 $= a^2 (\cos^2 \theta + \sin^2 \theta) + b^2 (\sin^2 \theta + \cos^2 \theta)$
 $= a^2 \times 1 + b^2 \times 1$
 $= a^2 + b^2$
 $\therefore (a \cos \theta - b \sin \theta)^2 + (a \cos \theta + b \sin \theta)^2 = a^2 + b^2$
 $\Rightarrow c^2 + (a \cos \theta + b \sin \theta)^2 = a^2 + b^2$
 $\Rightarrow a \cos \theta + b \sin \theta = \pm \sqrt{a^2 + b^2 - c^2}$

21. (d) New quantity of item D

$$= 40 \times \frac{150}{100} = 60 \text{ quintal}$$

$$\begin{aligned} \text{New price/kg of item D} \\ &= 90\% \text{ of ₹ } 12.5 \end{aligned}$$

$$= 12.5 \times \frac{90}{100} = ₹ 11.25/\text{kg}$$

$$\begin{aligned} \therefore \text{Total price} \\ &= ₹ (60 \times 100 \times 11.25) \\ &= ₹ 67500 \end{aligned}$$

22. (d) Required average price/kg

$$= ₹ \left(\frac{17.5 + 10 + 7.5}{3} \right) = ₹ \frac{35}{3} = ₹ 11.67$$

23. (a) Required ratio = $15 \times 25 : 10 \times 35$
 $= 3 \times 5 : 2 \times 7 = 15 : 14$

24. (d)

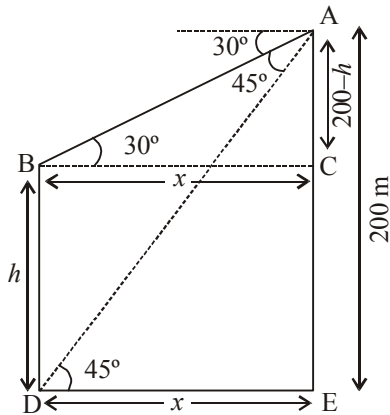

$$\begin{aligned} \text{In } \triangle ACB, \tan 30^\circ &= \frac{200-h}{x} = \frac{1}{\sqrt{3}} \\ &= \frac{500-h}{x} \end{aligned}$$

$$\Rightarrow x = (200-h)\sqrt{3} \quad \dots (i)$$

In $\triangle ADE$,

$$\tan 45^\circ = \frac{200}{x}$$

$$\Rightarrow 1 = \frac{200}{x} \Rightarrow x = 200 \text{ m}$$

From Eq. (i)

$$200 = (200-h)\sqrt{3}$$

$$\Rightarrow h = 200 \left(\frac{\sqrt{3}-1}{\sqrt{3}} \right) \text{ m}$$

25. (d) The stack is in the form having vertical cross section of trapezium.

\therefore Volume of Earth in the stack = Area of cross section of trapezium \times Height

$$\therefore \text{Volume} = \frac{1}{2} \times (10+5) \times 2 \times 8 = 15 \times 8 \text{ m}^2$$

According to the question,

Volume of Earth to be spread = (Area of field) \times Level raised

$$\therefore \text{Level raised} = \frac{15 \times 8}{100 \times 80} = \frac{15}{1000} \text{ m} = 1.5 \text{ cm}$$

26. (b) Let the divisor be x
 According to the question

$$\text{Quotient will be} = \frac{x}{25}$$

$$\text{Remainder} = \frac{x}{5}$$

Given, quotient = 16

$$\text{So, } \frac{x}{25} = 16$$

$$\therefore x = 25 \times 16 \quad \dots (i)$$

Dividend

= Divisor \times Quotient + remainder

$$= x \times \frac{x}{25} + \frac{x}{5} = \frac{x}{5} \left(\frac{x}{5} + 1 \right)$$

$$= \frac{16 \times 25}{5} \left(\frac{25 \times 16}{5} + 1 \right) \quad [\text{Putting the value of } x]$$

$$= \frac{16 \times 25 \times 405}{25} = 6480$$

OR, Divisor = $25 \times 16 = 400$

$$\text{Remainder} = \frac{400}{5} = 80$$

\therefore Dividend

$$= 400 \times 16 + 80 = 6480$$

27. (c) Greatest number of 5 digits is 99999.

$$\begin{array}{r} 3 \overline{) 9999 \text{ (316)}} \\ \underline{9} \\ 61 \overline{) 99} \\ \underline{61} \\ 626 \overline{) 3899} \\ \underline{3756} \\ 143 \end{array}$$

$$\therefore \text{Required number} = (99999 - 143) = 99856.$$

28. (a) LCM of 32, 36, 48, 54 = 864
 29. (b) Difference of marks = $72 + 61 - 48 - 65 = 20$
 Correct average marks
 $= 68 \frac{20}{20} = 68 \frac{1}{1} = 69$

30. (a) Let C.P. = ₹ 100, then M. P. = ₹ 150
 S.P. = 70% of 150 = ₹ 105

$$\therefore \% \text{ profit} = \frac{105 - 100}{100} \times 100 = 5\%$$

31. (a) Let the population of the village X be $5x$.
 and that of village Y = $7x$.
 According to the question,
 $\frac{5x}{7x} = \frac{25}{25000} \frac{25}{36}$
 $\Rightarrow 180x = 175x + 25 \times 25000 \Rightarrow 5x = 625000$
 $\therefore x = 625000$

32. (a) $15W = 10M$

$$\text{Now, } 5W + 4M = 5W + \frac{4 \times 15}{10} W$$

$$5W + 6W = 11W$$

If 15 women can complete the project in 55 days,

11 women can complete the same project in

$$\frac{55 \times 15}{11} = 75 \text{ days}$$

33. (a) Let the speed of the goods train be x kmph.
 Distance covered by goods train in 10 hours
 = Distance covered by express train in 4 hours.

$$\therefore 10x = 4 \times 90 \text{ or } x = 36.$$

So, speed of goods train = 36 kmph.

34. (a) Let the edge of the third cube be x cm.
 Then, $x^3 + 6^3 + 8^3 = 12^3$
 $\Rightarrow x^3 + 216 + 512 = 1728 \Rightarrow x^3 = 1000 \Rightarrow x = 10.$

Thus the edge of third cube = 10 cm.

35. (c) C.P. = $50 \times 4 = ₹ 200$
 Remaining eggs = $600 - 40 = 560$
 Let S.P. of eggs = ₹ x per dozen

$$\therefore \text{Total S.P.} = ₹ \frac{560}{12} x$$

$$\therefore \frac{560}{12} x = \frac{(100 - 5)\%}{100} \times 200$$

$$\Rightarrow x = \frac{105}{100} \times \frac{2400}{560} = ₹ 4.5 \text{ per dozen}$$

36. (a) Let cistern will be full in x min. Then,
 part filled by A in x min + part filled by B in
 $(x - 1)$ min + part filled by C in $(x - 2)$ min = 1

$$\Rightarrow \frac{x}{3} + \frac{x-1}{4} + \frac{x-2}{6} = 1$$

$$\Rightarrow 9x = 19 \Rightarrow x = \frac{19}{9} = 2 \frac{1}{9} \text{ min}$$

37. (d) Let the speed of the second train be x km/h
 The relative speed = $(50 + x)$ km/h
 These trains will cross each other in a time
 equivalent of covering a distance equal to
 $108 + 112$, i.e. 220 meters in 6 seconds,
 running a speed of $(50 + x)$ km/h

$$\therefore \frac{1}{50} \times \frac{220}{x} = \frac{6}{3600} \Rightarrow x = 82$$

\therefore The speed of the second train = 82 km/h.

38. (a) $y : x = 4 : 15 \Rightarrow x : y = 15 : 4$

By componendo and dividendo,

$$\frac{x-y}{x+y} = \frac{15-4}{15+4} = \frac{11}{19}$$

39. (a) $x + \frac{1}{4x} = \frac{3}{2} \Rightarrow 2x + \frac{1}{2x} = 3$

Cubing both sides,

$$8x^3 + \frac{1}{8x^3} + 3 \times 2x \times \frac{1}{2x}$$

$$\left(2x + \frac{1}{2x} \right) = 27$$

$$\Rightarrow 8x^3 + \frac{1}{8x^3} + 3 \times 3 = 27$$

$$\Rightarrow 8x^3 + \frac{1}{8x^3} = 27 - 9 = 18$$

40. (d) $\tan \theta = \frac{BC}{AB} = \frac{1}{\sqrt{7}} = \frac{1}{\sqrt{7}k}$

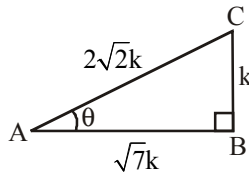

$$AC^2 = (AB^2 + BC^2) = (7k^2 + k^2) = 8k^2$$

$$\therefore AC = \sqrt{8k^2} = 2\sqrt{2}k$$

$$\sec \theta = \frac{AC}{AB} = \frac{2\sqrt{2}k}{\sqrt{7}k} = \frac{2\sqrt{2}}{\sqrt{7}}$$

$$\operatorname{cosec} \theta = \frac{AC}{BC} = \frac{2\sqrt{2}k}{k} = 2\sqrt{2}$$

$$\therefore \frac{\operatorname{cosec}^2 \theta - \sec^2 \theta}{\operatorname{cosec}^2 \theta + \sec^2 \theta} = \frac{2\sqrt{2}^2 - \left[\frac{2\sqrt{2}}{\sqrt{7}}\right]^2}{2\sqrt{2}^2 + \left[\frac{2\sqrt{2}}{\sqrt{7}}\right]^2}$$

$$= \left[\frac{8 - \frac{8}{7}}{8 + \frac{8}{7}} \right] = \frac{48}{64} = \frac{3}{4}$$

41. (b) First is an instrument to measure the second.

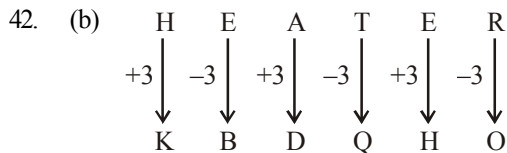

Similarly,

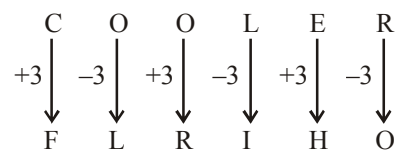

43. (d) $12 = 3^2 + 3, \quad 30 = 5^2 + 5 :$
 $20 = 4^2 + 4 : \quad ? = 6^2 + 6$

44. (a) Microbe is living organism others are scientific apparatus.

45. (d) The pattern is -

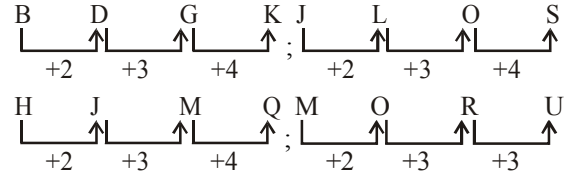

Hence, MORU is odd one out.

46. (a) 1st letter moves -2 steps each time.

2nd letter moves +1, +2, +3, +4 steps respectively.

3rd letter moves +2, +3, steps alternatively.

47. (c) $1^3 + 1^2 = 2, 2^3 + 2^2 = 12, 3^3 + 3^2 = 36$ and so on $\therefore 6^3 + 6^2 = 252$

48. (a)

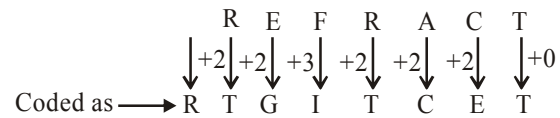
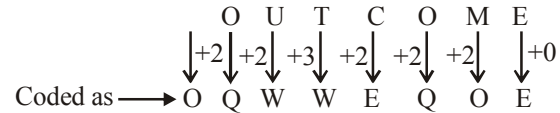

49. (b) A = 1

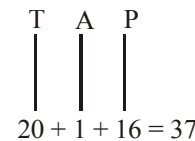
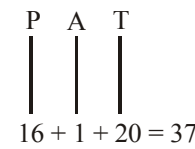

50. (a) Father of Rajesh's brother is the father of Rajesh. Rajesh's father is the only son of Neha's grandfather. Hence, Rajesh's father is Neha's father. So, Neha is the sister of Rajesh.

51. (c)

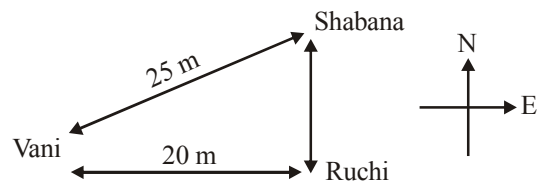

52. (b) New arrangement of numbers is as follows:
15698372

Hence, third number from right end is 3.

53. (a) Total boys

$$\left[\begin{array}{cc} \text{Mahendra's place} & \text{Surendra's place} \\ \text{from left} & \text{from right} \end{array} \right] + \left[\begin{array}{c} \text{Boys between} \\ \text{them} \end{array} \right]$$

$$= [17 + 18] + 8 = 43$$

54. (b) $(5 - 1) \times (6 - 3) = 12$

$$(7 - 3) \times (8 - 3) = 20$$

$$(7 - 2) \times (6 - 3) = 15$$

55. (c) As, $3 \times 7 = 21$, $11 \times 7 = 77$

$$4 \times 9 = 36$$

$$12 \times 9 = 108$$

$$\text{Therefore, } 14 \times 8 = 112$$

$$? \times 8 = 24$$

$$\boxed{? \quad 3}$$

56. (c) Silver jubilee - 25 yr.

Golden jubilee - 50 yr.

Diamond jubilee - 75 yr.

Centenary - 100 yr

Millennium - 1000 yr.

57. (b) SIGNAL

58. (c) Area common to \bigcirc and \triangle .

59. (a) Conclusions:

I. (True)

II. (True)

Hence, option (a) is the correct answer.

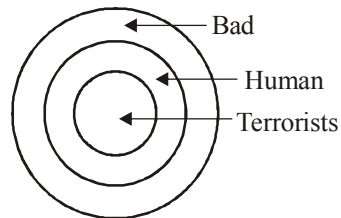

60. (b) $6 \times 4 - 9 = 15$

61. (c) By options -

(a) $22 \times 7 + 3 - 9 = 148$

$$154 + 3 - 9$$

$$157 - 9 = 148 \text{ (correct)}$$

(b) $33 - 5 + 10 \times 20 = 228$

$$33 - 5 + 200$$

$$200 + 33 - 5$$

$$233 - 5 = 228 \text{ (correct)}$$

(c) $7 \times 28 + 3 - 52 = 127$

$$196 + 3 - 52$$

$$199 - 52 = 147 \text{ (incorrect)}$$

(d) $44 + 9 \times 6 - 11 = 87$

$$44 + 54 - 11$$

$$98 - 11 = 87 \text{ (correct)}$$

62. (c) From figures (i), (ii) and (iii), we conclude that 3, 4, 2 and 6 lie adjacent to 5. Therefore, 1 must lie opposite 5.

From figures (i), (iii) and (iv), we conclude that 4, 5, 6 and 1 lie adjacent to 3. Therefore, 2 must lie opposite 3. Now, we have 1 opposite 5 and 2 opposite 3. Hence, 4 must lie opposite 6.

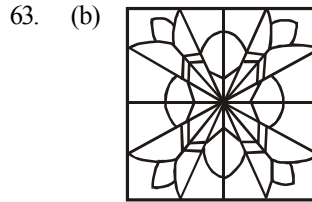

64. (c)

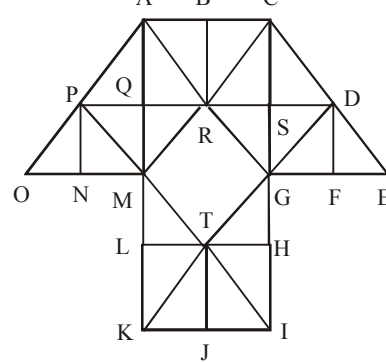

The simplest triangles are:

$\triangle PNO$; $\triangle PNM$; $\triangle MPQ$;

$\triangle MQR$; $\triangle AQP$; $\triangle AQR$;

$\triangle BRA$; $\triangle BRC$; $\triangle SRC$;

$\triangle SCD$; $\triangle SGR$; $\triangle SGD$;

$\triangle DFG$; $\triangle DFE$; $\triangle TLM$;

$\triangle TJK$; $\triangle TLK$; $\triangle TIH$;

The triangles composed of two components are:

$\triangle PON$; $\triangle PMA$; $\triangle APR$;

$\triangle RAM$; $\triangle RAC$; $\triangle RGC$;

$\triangle DGC$; $\triangle DGE$; $\triangle MPR$;

$\triangle GRD$; $\triangle DGE$; $\triangle TMK$;

$\triangle TKI$; $\triangle TIG$

The triangles composed of four components are:

$\triangle AMO$; $\triangle AMC$; $\triangle CAG$;

$\triangle CGE$; $\triangle MKI$; $\triangle GIK$;

Other triangles are: $\triangle SPI$; $\triangle DQK$

Total number of triangles

$$18 + 14 + 6 + 2 = 40$$

65. (c)
 66. (d) The colour of human blood is red. Here *white* means *red*. Therefore *white* is our answer.
 Do not opt for *black* because *red* means *black* implies that black is called red.
 67. (d) PSICHO LAZY
 0 1 2 3 4 5 6 7 8 9
 875.50 = ZAO.OP

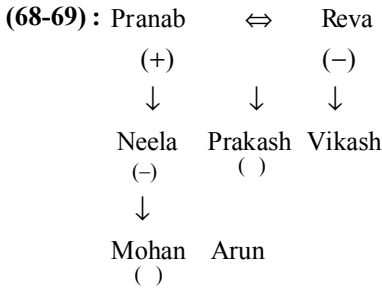

68. (a) 69. (c)

(70-72).

- A + B ⇒ A is the father of B.
 A × B ⇒ A is the sister of B.
 A \$ B ⇒ A is the wife of B.
 A % B ⇒ A is the mother of B.
 A ÷ B ⇒ A is the son of B.

70. (a) J ÷ P % H × T % L can be represented in diagram. As follows.

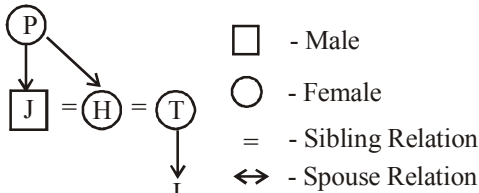

71. (b) L + R \$ D + M × T

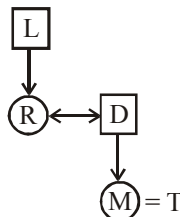

72. (b) I + T % J × L ÷ K

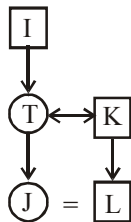

73. (b)

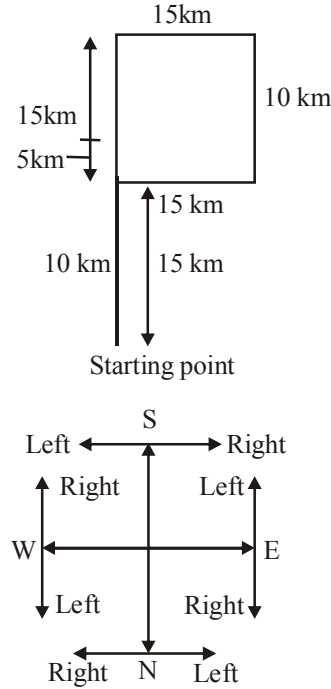

So, he is 10 metres from his starting point.

74. (b) No of boys = x; No of girls = 2x;
 $x + 2x = 90 \Rightarrow 3x = 90$
 x (Boys) = 30 ; $2x$ (Girls) = 60
 Number of student behind Shridar = $90 - 14 = 76$
 No of girls behind Shridar = $60 - 10 = 50$
 No of boys behind Shridar = $76 - 50 = 26$

75. (b) Given that,
 $Q < R$ and U
 also $T > P > S$ and $R > P$
 Q got the second least rank and U got the second highest rank.

So, T should have got least and S should have got the highest ranks.

\underline{T} \underline{Q} $\underline{\quad}$ $\underline{\quad}$ \underline{U} \underline{S}
 Since $R > P$ the final arrangement is as follows.

Student	T	Q	R	P	U	S
Rank	6	5	4	3	2	1

76. (a) T

77. (d)
- | | | | | | | | | |
|---|---|---|---|---|---|---|---|---|
| 1 | 3 | 4 | 7 | 9 | 2 | 5 | 6 | 8 |
| A | Q | F | J | L | D | M | P | N |

Thus,

3	9	6	8	2	4
Q	L	P	N	D	F

78. (c) The - ji from 2nd and 3rd code, aim and zo only present in 2nd code.
From 3rd and 4th code, stadium - ku
79. (d) From 1st and 4th, was - ho,
from 1st and 3rd - singing - ta
bo and she not present anywhere.
80. (c) From 3rd, at - ma
81. (d) It was constituted by Shivaji in Maratha administration.
82. (c) Bengal Gazette was published by James Augustus Hickey in 1780.
83. (c) Jatindra Nath Das (27 October 1904 - 13 September 1929), also known as Jatin Das, was an Indian freedom fighter and revolutionary. He died in Lahore jail after a continuous hunger strike for 63 days demanding equality for Indian prisoners and undertrials.
84. (d) 'Federal' term is not used in the preamble of the Indian constitution.
85. (b) The Prime Minister of India is the head of the Central Government.
86. (c) There are 5 types of writs can be issued by the Supreme Court
87. (d) The Indian Economy is characterised by pre-dominance of agriculture, low per capita income and massive unemployment.
88. (d) The Green Revolution in India has contributed to inter-regional, inter-class and inter-crop inequality.
89. (c) Middle luminous zone of a candle flame is the hottest.
90. (d)
91. (c) In Astigmatism, eye cannot see objects in two orthogonal directions clearly simultaneously. This abnormality is removed by using cylindrical lens.
92. (d) Fertilizers are those compounds which provide essential primary nutrients (nitrogen, phosphorus and potassium) required for healthy growth of plants and crops. Nitrogenous fertilizer provide nitrogen, phosphatic fertilizer provide phosphorus whereas potash fertilizer provide potassium to soil. NPK fertilizers are mixed fertilizers. They provide all three essential nutrients (nitrogen, phosphorus and potassium). NPK fertilizers contains nitrogen, phosphorus and potassium in different proportion depending upon the requirement of soil.
93. (a) Fluorine is the most reactive among all halogens. However the reactivity decreases from F_2 to I_2 (from top to bottom of group) may be attributed to
(1) Low dissociation enthalpies
(2) High electron affinities
94. (d) Potato tuber bears buds in small pits known as eyes. Buds develops to branches. Some of the branches become green, erect & leafy stems that grow horizontally under ground.
95. (b) Athlete's Foot disease is caused by parasitic fungus of genus Trichophyton. Scaling, flaking and itching of affected areas are the symptoms of this disease. This disease transmitted in moist areas where people walk bare foot.
96. (b) Chlorophyll is a tetrapyrrole ring system that chelate the magnesium ion. The tetrapyrrole ring system that chelates this magnesium shows a conjugated double bond. This bond provide the light absorption feature to chlorophyll and gives it green colour.
97. (d) The stomach is divided into two parts fundic and pyloric region. The pyloric region opens into small intestine through pyloric valve of pylorus.
98. (a) 99. (c) 100. (d) 101. (c) 102. (b)
103. (c) 104. (b) 105. (b) 106. (b) 107. (a)
108. (b) 109. (a) 110. (a) 111. (c) 112. (b)
113. (b) 114. (d) 115. (a)
116. (c) Michael Flynn
117. (a) Euro
118. (a) Bull
119. (d) Peggy Whitson
120. (b) Minister of Petroleum and Natural Gas, Dharmendra Pradhan announced that people can get cash at select petrol pumps with SBI machines by swiping their debit cards from November 18, 2016.

ARITHMETIC

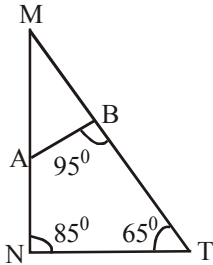
- A certain number is divided by 385 by division by factors. The quotient is 102, the first remainder is 4, the second is 6 and the third is 10. Find the number.
(a) 39654 (b) 32754
(c) 38554 (d) None of these
- Two different numbers when divided by the same divisor, left remainder 11 and 21 respectively, and when their sum was divided by the same divisor, remainder was 4. What is the divisor?
(a) 36 (b) 28
(c) 14 (d) 9
- A shopkeeper fixes the marked price of an item 20% above the cost price. He allows his customers a discount and makes a profit of 8%. Find the rate of discount.
(a) 8% (b) 9%
(c) 10% (d) 11%
- Mr. Thomas invested an amount of ₹ 13,900 divided in two different schemes A and B at the simple interest rate of 14% p.a. and 11% p.a. respectively. If the total amount of simple interest earned in 2 years be ₹ 3508, what was the amount invested in Scheme B?
(a) ₹ 6400 (b) ₹ 6500
(c) ₹ 7200 (d) ₹ 7500
- The difference between C. I. (Compound Interest) and S.I. (Simple Interest) on a sum of ₹ 4,000 for 2 years at 5% p.a. payable yearly is
(a) ₹ 20 (b) ₹ 10
(c) ₹ 50 (d) ₹ 60
- A, B and C are partners. A receives $\frac{9}{10}$ of the profit and B and C share the remaining profit equally. A's income is increased by ₹ 270 when the profit rises from 12 to 15%. Find the capital invested by B and C each
(a) ₹ 5000 (b) ₹ 1000
(c) ₹ 500 (d) ₹ 1500
- A machine P can print one lakh books in 8 hours, machine Q can print the same number of books in 10 hours while machine R can print them in 12 hours. All the machines are started at 9 a.m. while machine P is closed at 11 a.m. and the remaining two machines complete the work. Approximately at what time will the work be finished?
(a) 11 : 30 am (b) 12 noon
(c) 12 : 30 pm (d) 1 pm
- A man walks half of the journey at 4 km/h by cycle does one third of journey at 12 km/h and rides the remainder journey in a horse cart at 9 km/h, thus completing the whole journey in 6 hours and 12 minutes. The length of the journey is
(a) 36km (b) 39km
(c) 40km (d) 28km
- If $x^2 + y^2 + 2x + 1 = 0$, then the value of $x^{31} + y^{35}$ is
(a) -1 (b) 0
(c) 1 (d) 2
- If $2^x = 3^y = 6^{-z}$ then $\left(\frac{1}{x} \frac{1}{y} \frac{1}{z}\right)$, is equal to
(a) 0 (b) 1
(c) $\frac{3}{2}$ (d) $-\frac{1}{2}$
- If $m - \frac{1}{m-2} = 4$ then, what is value of $(m-2)^2 + \frac{1}{(m-2)^2}$?
(a) -2 (b) 0
(c) 2 (d) 4
- O is the centre of the circle passing through the points A, B and C such that $\angle BAO = 30^\circ$, $\angle BCO = 40^\circ$ and $\angle AOC = x^\circ$. What is the value of x ?
(a) 70° (b) 140°
(c) 210° (d) 280°
- In the figure, if $\frac{NT}{AB} = \frac{9}{5}$ and if MB = 10, find MN.

(a) 5 (b) 4
(c) 28 (d) 18

14. Two parallel chords of a circle of diameter 20 cm are 12 cm and 16 cm long. If the chords are in the same side of the centre, then the distance between them is
 (a) 28 cm (b) 2 cm
 (c) 4 cm (d) 8 cm

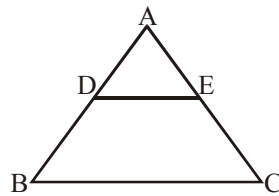
15. In $\triangle ABC$, $DE \parallel BC$ and $\frac{AD}{DB} = \frac{3}{5}$. If $AC = 5.6$ cm, find AE .

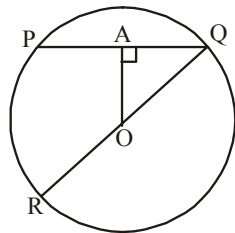

- (a) 2.1 cm (b) 3.1 cm
 (c) 1.2 cm (d) 2.3 cm
16. OA is perpendicular to the chord PQ of a circle with centre O . If QR is a diameter, $AQ = 4$ cm, $OQ = 5$ cm, then PR is equal to



- (a) 6 cm (b) 4 cm
 (c) 8 cm (d) 10 cm
17. If the coordinates of the points A, B, C be $(4, 4), (3, -2)$ and $(3, -16)$ respectively, then the area of the triangle ABC is:
 (a) 27 (b) 15
 (c) 18 (d) 7

18. If $\sin \theta - \cos \theta = \frac{7}{13}$ and $0 < \theta < 90^\circ$, then the value of $\sin \theta + \cos \theta$ is.

- (a) $\frac{17}{13}$ (b) $\frac{13}{17}$
 (c) $\frac{1}{13}$ (d) $\frac{1}{17}$

19. If $\frac{x \operatorname{cosec}^2 30^\circ \cdot \sec^2 45^\circ}{8 \cos^2 45^\circ \cdot \sin^2 60^\circ} = \tan^2 60^\circ - \tan^2 30^\circ$, then $x = ?$
 (a) 1 (b) -1
 (c) 2 (d) 0

20. If θ & $2\theta - 45^\circ$ are acute angles such that $\sin \theta = \cos (2\theta - 45^\circ)$ then $\tan \theta$ is equal to
 (a) 1 (b) -1
 (c) $\sqrt{3}$ (d) $\frac{1}{\sqrt{3}}$

DIRECTIONS (Q. 21-23) : Study the following graph carefully to answer the questions that follow:

Number of Students Enrolled in Three Different Disciplines in Five Different Colleges

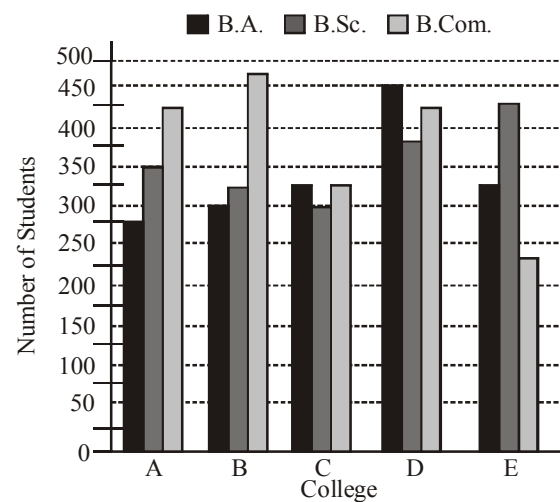

21. What is the total number of students studying B.Sc. in all Colleges together?
 (a) 1825 (b) 1975
 (c) 1650 (d) 1775
22. What is the respective ratio of total number of students studying B.Sc. in the colleges C and E together to those studying B.A. in the Colleges A and B together?
 (a) 24 : 23 (b) 25 : 27
 (c) 29 : 23 (d) 29 : 27
23. What is the respective ratio of total number of students studying B.Sc., B.A. and B.Com. in all the Colleges together?
 (a) 71 : 67 : 75 (b) 67 : 71 : 75
 (c) 71 : 68 : 75 (d) 75 : 71 : 68
24. A cylindrical bucket of height 36 cm and radius 21 cm is filled with sand. The bucket is emptied on the ground and a conical heap of sand is formed, the height of the heap being 12 cm. The radius of the heap at the base is :
 (a) 63 cm (b) 53 cm
 (c) 56 cm (d) 66 cm

25. A conical vessel, whose internal radius is 12 cm and height 50 cm, is full of liquid. The contents are emptied into a cylindrical vessel with internal radius 10 cm. Find the height to which the liquid rises in the cylindrical vessel.
- (a) 18 cm (b) 22 cm
(c) 24 cm (d) None of these
26. Two numbers are in the ratio 17 : 45. One-third of the smaller is less than $\frac{1}{5}$ of the bigger by 15. The smaller number is
- (a) $25\frac{1}{2}$ (b) $67\frac{1}{2}$
(c) $76\frac{1}{2}$ (d) $86\frac{1}{2}$
27. The value of $\sqrt{10 \sqrt{25 \sqrt{108 \sqrt{154 \sqrt{225}}}}}$ is :
- (a) 4 (b) 6
(c) 8 (d) 10
28. Find the greatest number that will divide 55, 127 and 175 so as to leave the same remainder in each case.
- (a) 26 (b) 24
(c) 23 (d) 29
29. The average age of a group of 16 persons is 28 yrs and 3 months. Two persons each 58 yrs old left the group. The average age of the remaining persons is
- (a) 26 (b) 24
(c) 22 (d) 20
30. A milk man makes a profit of 20% on the sale of milk. If he were to add 10% water to the milk, by what % would his profit increase?
- (a) 30 (b) $\frac{40}{3}$
(c) 22 (d) 10
31. If $\frac{a}{3} = \frac{b}{4} = \frac{c}{7}$, then $\frac{a}{c} - \frac{b}{c}$ is equal to:
- (a) 7 (b) 2
(c) $\frac{1}{2}$ (d) $\frac{1}{7}$
32. A can do a piece of work in 10 days, while B alone can do it in 15 days. They work together for 5 days and the rest of the work is done by C in 2 days. If they get Rs 450 for the whole work, how should they divide the money ?
- (a) Rs 225, Rs 150, Rs 75
(b) Rs 250, Rs 100, Rs 100
(c) Rs 200, Rs 150, Rs 100
(d) Rs 175, Rs 175, Rs 100
33. Without stoppages, a train travels certain distance with an average speed of 80 km/h, and with stoppages, it covers the same distance with an average speed of 60 km/h. How many minutes per hour the train stops ?
- (a) 15 (b) 18
(c) 10 (d) None of these
34. A well 22.5 deep and of diameter 7 m has to be dug out. Find the cost of plastering its inner curved surface at ₹ 3 per sq. metre.
- (a) ₹ 1465 (b) ₹ 1485
(c) ₹ 1475 (d) ₹ 1495
35. The difference between the selling price of a clock at a profit of 8% and 10% is ₹ 6. Find the cost price of the clock.
- (a) ₹ 1200 (b) ₹ 600
(c) ₹ 400 (d) ₹ 300
36. A tank is filled in 5 hours by three pipes A, B and C. The pipe C is twice as fast as B and B is twice as fast as A. How much time will pipe A alone take to fill the tank ?
- (a) 20 hrs (b) 25 hrs
(c) 35 hrs (d) Cannot be determined
37. A train 100 m long passes a bridge at the rate of 72 km/h per hour in 25 seconds. The length of the bridge is :
- (a) 150m (b) 400m
(c) 300m (d) 200m
38. If $x^2 + y^2 + z^2 = xy + yz + zx$, ($x \neq 0$), then the value of $\frac{4x + 2y - 3z}{2x}$ is
- (a) 0 (b) 1
(c) $\frac{3}{2}$ (d) $\frac{1}{2}$
39. If $x + \frac{1}{x} = \sqrt{3}$ then the value of $x^{18} + x^{12} + x^6 + 1$ is
- (a) 0 (b) 1
(c) 2 (d) 3
40. If $\sin \theta + \sqrt{\sin \theta + \sqrt{\sin \theta + \sqrt{\sin \theta + \dots \infty}}} = \sin^4 \alpha$, then $\sin \theta$ is equal to
- (a) $\sec^2 \alpha$ (b) $\tan^2 \alpha$
(c) $\sec^2 \alpha \tan^2 \alpha$ (d) $\cos^2 \alpha$

GENERAL INTELLIGENCE & REASONING

DIRECTIONS (Qs. 41 to 43) : In each of the following questions, there are two words / set of letters / numbers to the left of the sign :: which are connected in some way. The same relationship obtains between the third words / set of letters / numbers and one of the four alternatives under it. Find the correct alternative in each question.

41. Foresight : Anticipation :: Insomnia : ?
 (a) Treatment (b) Disease
 (c) Sleeplessness (d) Unrest
42. PAPER : SCTGW :: MOTHER : ?
 (a) ORVLGW (b) PQVIGT
 (c) PQXJJT (d) PQXKJV
43. 182 : ? :: 210 : 380
 (a) 342 (b) 272
 (c) 240 (d) 156

DIRECTIONS (Qs. 44 to 46) : Find the odd word/ letters/number pair from the given alternatives.

44. (a) Anxiety (b) Worry
 (c) Inhibition (d) Curiosity
45. (a) PROQN (b) DECEG
 (c) GIFHE (d) KMJLI
46. (a) 117-143 (b) 142-156
 (c) 64-78 (d) 103-169

DIRECTIONS (Qs. 47 to 49) : Complete the given series.

47. ABD, DGK, HMS, MTB, SBL, ?
 (a) ZAB (b) XKW
 (c) ZKU (d) ZKW
48. 165, 195, 255, 285, 345, ?
 (a) 375 (b) 390
 (c) 420 (d) 435
49. 24, 60, 120, 210, ?
 (a) 300 (b) 336
 (c) 420 (d) 525
50. In a code, CORNER is written as GSVRIV. How can CENTRAL be written in that code?
 (a) DFOUSBM (b) GIRXVEP
 (c) GJRYVEP (d) GNFJKER
51. If LOVE is coded as 27 then how is COME coded as:-
 (a) 38 (b) 18
 (c) 28 (d) 8

52. A is B's sister. C is B's mother. D is C's father. E is D's mother. Then, how is A related to D?
 (a) Grandmother (b) Grandfather
 (c) Daughter (d) Granddaughter
53. M is to the East of D, F is to the South of D and K is to the West of F. M is in which direction with respect to K?
 (a) South-West (b) North-West
 (c) North-East (d) South-East
54. Ketan takes casual leave only on first working day of every month. The office has weekly offs on Saturday and Sunday. In a month of 30 days, the first working day happened to be Tuesday. What will be the day for his next casual leave?
 (a) Wednesday (b) Thursday
 (c) Friday (d) Monday
55. In a row of boys facing the North, A is sixteenth from the left end and C is sixteenth from the right end. B, who is fourth to the right of A, is fifth to the left of C in the row. How many boys are there in the row ?
 (a) 39 (b) 40
 (c) 41 (d) 42
56. Malay Pratap is on 13th position from the starting and on 17th position from the end in his class. He is on 8th position from the starting and on 13th position from the end among the students who passed. How many students failed?
 (a) 7
 (b) 8
 (c) 9
 (d) Cannot be determined



DIRECTIONS (Qs. 57 - 58) : In the following questions find the missing number

57.

5	9	15
16	29	?
49	89	147

 (a) 45 (b) 48
 (c) 51 (d) 54

58.

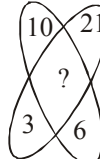
		
---	---	---

 (a) 60 (b) 62
 (c) 64 (d) 66

59. Which one of the given responses would be a meaningful order of the following ?

- | | |
|--------------|-------------|
| 1. apartment | 2. town |
| 3. street | 4. building |
| 5. complex | |
- (a) 1, 5, 4, 3, 2 (b) 4, 5, 3, 2, 1
 (c) 2, 1, 3, 4, 5 (d) 1, 4, 5, 3, 2

DIRECTIONS (Q. 60) : In question below are given two statements followed by two conclusions. You have to take the given statements to be true even if they seem to be at variance with commonly known facts. Read all the conclusions and then decide which of the given statements disregarding commonly know facts. *Given Answer:*

- Give answer (a)** If only conclusion I follows.
Give answer (b) if only conclusion II follows.
Give answer (c) if either I or II follows.
Give answer (d) if neither I nor II follows.

60. **Statements:**

- Some books are pens.
 No pen is pencil.

Conclusions:

- I** Some books are pencils.
II No book is pencil.

61. If '-' stand for addition, '+' stands for subtraction, '÷' stands for multiplication and '×' stands for division, then which one of the following equations is correct?

- (a) $25 \times 5 \div 20 - 27 + 7 = 120$
 (b) $25 + 5 \times 20 - 27 \div 7 = 128$
 (c) $25 + 5 - 20 + 27 \times 7 = 95$
 (d) $25 - 5 + 20 \times 27 \div 7 = 100$

62.

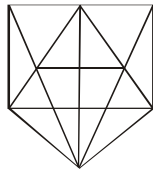

How many triangles are there ?

- (a) 20 (b) 21
 (c) 26 (d) 28

DIRECTIONS (Q. 63) : In the following question, you are given a figure (X) followed by four alternative figures (a), (b), (c) and (d) such that fig. (X) is embedded in one of them. Trace out the alternative figure which contains fig. (X) as its part.

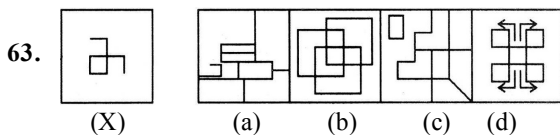

DIRECTIONS (Q. 64) : In each of the following questions, choose the correct **water image** of the figure (X) from amongst the four alternatives (a), (b), (c), (d) given alongwith it.

64. **absence**

- (a)
- (b)
- (c)
- (d)

65. There are two dots placed in the question figure. Find out the answer figure which has the possibility of placing the dots satisfying the same condition as in the question figure.

Questions Figure

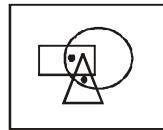

Answer Figure

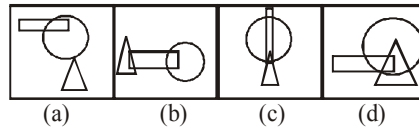

DIRECTIONS (Qs. 66-67): In each question below are three statements followed by three conclusions numbered I, II and III. You have to take the three given statements to be true even if they seem to be at variance from commonly known facts and then decide which of the answers (a), (b), (c), (d) and (e) is the correct answer and indicate it on the answer sheet.

66. **Statements:** All flats are buildings.
 All buildings are bungalows.
 All bungalows are apartments.

Conclusions: **I** Some apartments are flats.
II All flats are bungalows.
III Some bungalows are flats.

- (a) None follows
 (b) Only I and II follow
 (c) Only II and III follow
 (d) All I, II and III follow

67. **Statements:** Some spectacles are lenses.
 Some lenses are frames.
 All frames are metals.

- Conclusions:** **I** Some lenses are metals
II Some metals are spectacles.
III Some frames are spectacles.

- (a) Only III follows
 (b) Only I follows
 (c) Only I and either II or III follow
 (d) Only I and II follow
68. How many even numbers are there in the following sequence of numbers which are immediately preceded by an odd number but immediately followed by an even number?
 5 1 4 7 3 9 8 5 7 2 6 3 1 5 8 6 3 8 5 2 3 4 3 4 9 6
- (a) One (b) Three
 (c) Four (d) Two
69. In the following question four words are given, out of which three are alike in some manner and fourth one is different. Choose out the odd one.
- (a) Circle (b) Ellipse
 (c) Sphere (d) Cube

DIRECTIONS (Q. 70-71): Below is given a figure made of three circles intersecting one another. These circles represent graduates, typists and Government employees. The intersecting regions have been denoted by a, b, c, e, f, g and h, respectively. Study the diagram carefully and answer the questions that follow.

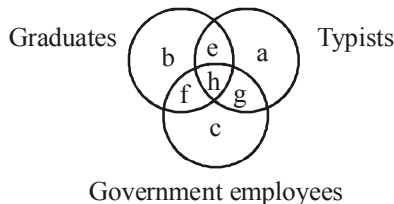

70. Which of the following letters represents the typists who are only graduates ?
- (a) e (b) h
 (c) g (d) a
71. Which of the following letters represents the typists who are government employees but not graduates?
- (a) e (b) g
 (c) f (d) h
72. In a certain code, a number 13479 is written as AQFJL and 2568 is written as DMPN. How is 396824 written in that code?
- (a) QLPNMJ (b) QLPNMF
 (c) QLP MNF (d) QLP NDF
73. In a certain code OVER is written as \$#%*. and VIST is written as #+×-. How is SORE written in that code?
- (a) ×\$*% (b) %×\$*
 (c) ×*\$% (d) ×%*\$

74. A boy goes to see a film and finds a man who is his relative. The man is the husband of the sister of his mother. How is the man related to the boy?
- (a) Brother (b) Nephew
 (c) Uncle (d) Father

DIRECTIONS (Qs. 75-77) : Read the following information carefully to answer the given questions.

V, U and T are sitting around a circle. A, B and C are also sitting around the same circle but two of them are not facing centre (they are facing the direction opposite to centre). Y is second to the left of C. U is second to the right of A. B is third to the left of T. C is second to the right of T. A is seated next to V.

75. Which of the following are not facing centre?
- (a) BA (b) CA
 (c) BC (d) Cannot be determined
76. Which of the following is the position of T in respect of B?
- (a) Third to the right
 (b) Second to the right
 (c) Third to the left
 (d) Third to the left or right
77. What is the position of V in respect of C?
- (a) Second to the right
 (b) Third to the left
 (c) Fourth to the right
 (d) Fourth to the left
78. Which of the following has the same relationship as that of 'PS' : 'TW'?
- (a) JM : RQ (b) AD : DI
 (c) AD : EH (d) FC : ZE
79. In the following question three out of four alternatives contain letters of the alphabet placed in a particular form. Find the one that does not belong to the group.
- (a) HMNG (b) VQRU
 (c) KDPJ (d) TUVS
80. When Amir saw Manjeet, he recalled that he is son of the father of the mother of his daughter. Manjeet is Amir's:
- (a) Brother-in-law (b) Brother
 (c) Cousin (d) Uncle
- GENERAL AWARENESS**
81. In context of Mauryan period 'Gudhapurushas' referred to –
- (a) Detectives (b) Blacksmith
 (c) Army commander (d) Chariot rider

82. Which among the following parts of a plant is involved in gaseous exchange?
 (a) Stomata (b) Lenticels
 (c) Vacuoles (d) Stomata & Lenticels
83. Who among the following led the agitation against the Partition of Bengal (1905)? (1905)
 (a) Surendranath Banerjee
 (b) C.R. Das
 (c) Ashutosh Mukharjee
 (d) Rabindra Nath Tagore
84. Graphite is used in nuclear reactors for –
 (a) reducing the speed of fast neutrons
 (b) cooling the reactor
 (c) absorbing neutrons
 (d) None of the above
85. The Republic Day parade, held every year, is organized by which of the following ministries?
 (a) Union Home Ministry
 (b) Union Ministry of Defence
 (c) Union Ministry of Finance
 (d) Union Ministry of Information and Broadcasting
86. Which of the following articles can not be suspended upon the proclamation of the National Emergency?
 (a) Article 20 and 21
 (b) All Fundamental Rights
 (c) All Fundamental Rights and Directive Principles of State Policy
 (d) None of the above
87. What would be the effect on an economy if money supply is increased more than market expectations because of decision on part of the Central Bank?
 (a) Balance of Payment increases
 (b) Growth in Import
 (c) Hyperinflation
 (d) Stagflation
88. How many members are nominated by the governor in the Legislative Council of the State?
 (a) 1/3rd of the total membership
 (b) 1/6th of the total membership
 (c) 1/12th of the total membership
 (d) 12 members
89. Which of the following book is centred on “Environment”?
 (a) The Late, Great Planet Earth
 (b) Silent Spring
 (c) Here I stand
 (d) And then One Day
90. Pandit Jawaharlal Nehru drafted the resolution on Fundamental Rights an Economic Programme at which session of Indian National Congress?
 (a) Lahore Session (b) Bombay Session
 (c) Calcutta Session (d) Karachi Session
91. If an insect that feeds on feces sits on the food you are going to eat, you are most likely to be infected by which disease?
 (a) Tuberculosis (b) Cholera
 (c) Typhoid (d) Hepatitis B
92. Which of the following is not an antibiotics?
 (a) Penicilin (b) Ampicilin
 (c) Streptomycin (d) Aspirin
93. In which north east state of India Rongbang dare waterfall is situated?
 (a) Assam (b) Meghalaya
 (c) Manipur (d) Mizoram
94. The purpose of ‘selective credit control’ in hands of Reserve Bank of India is to –
 (a) Diversify credit to sensitive commodities.
 (b) Diversify credit to selected sectors.
 (c) Regulate credit in sensitive commodities.
 (d) Regulate credit in priority sectors.
95. Mitosis is a type of cell division in which –
 (a) The chromosomes maintain their original number.
 (b) The chromosome number is reduced to half.
 (c) The Chromosome number is doubled.
 (d) The chromosome number is reduced to one fourth.
96. WiMax stands for – Wimax
 (a) Worldwide interoperability for Microwave Access
 (b) Wireless Maximum
 (c) Wireless international Microwave Access
 (d) Worldwide Microwave Access
97. Ginger is an example of –
 (a) Modified Node (b) Modified Root
 (c) Modified Stem (d) Tap Root
98. Which of the following is not the mission of ISRO?
 (a) SURYA
 (b) Mars Orbiter Mission
 (c) YOUTHSAT
 (d) ADITYA-1
99. The first death anniversary day of Sri Rajiv Gandhi was observed as the —
 (a) National Integration Day
 (b) Peace and love Day
 (c) Secularism Day
 (d) Anti-terrorism Day
100. What is the ratio of money held by the public in currency to that they held in deposit ?
 (a) The currency deposit ratio
 (b) The reserve deposit ratioSS
 (c) Cash reserve ratio
 (d) Cash deposit ratio

101. Before X-ray examination (coloured X-ray) of the stomach, patients are given suitable salt of barium because.
- barium is a good absorber of X-rays and helps stomach to appear clearly
 - barium salts are white in colour and this helps stomach to appear clearly
 - barium allows X-rays to pass through the stomach
 - barium salts are easily available
102. If the length of a simple pendulum is halved then its period of oscillation is –
- doubled
 - halved
 - increased by a factor $\sqrt{2}$
 - decreased by a factor $\sqrt{2}$
103. Kalinga Prize is given in which of the following fields ?
- Arts
 - Medicine
 - Creative writing
 - Science
104. Who was appointed as the head of New Health Emergencies Programme by World Health Organisation (WHO) in June 2016?
- Peter Salama
 - Samantha Power
 - Sacha Llorenti
 - John Ashe
105. Which state Government launched Kalinga Sikha Sathi Yojana (KSSY)?
- Madhya Pradesh
 - Maharashtra
 - Odisha
 - Kerala
106. Two different files can have the same name if
- they are in different folders
 - they are on different drives
 - they are on the same drive
 - both (a) and (b)
107. A device that is connected to the motherboard is
- called an external device
 - called an adjunct device
 - called a peripheral device
 - must connect using ribbon cable
108. The first computers were programmed using
- assembly language
 - machine language
 - spaghetti code
 - source code
109. Documentation of computer programs is important so that
- users can learn how to use the program
 - other programmers can know how to maintain the program
 - the programmer can see why the code is written that way while hunting for source of error
 - All of the above
110. Provide the means to move the pointer on the screen and give information to the computer by clicking its buttons
- scanner
 - mouse
 - keyboard
 - program
111. Read the Following Railway Headquarters and Identify which is False ?
- South-Central Railway - Secunderabad
 - Central railway - Bhopal
 - South Railway - Chennai
 - North Railway - New Delhi
112. First Indian train was started ?
- From Calcutta to Delhi
 - From Mumbai to Thane
 - From Mumbai to Surat
 - From Mumbai to Madras
113. Where is Asia's biggest Container Depot located?
- mughal sarai
 - Gorakhpur
 - Delhi
 - kolkata
114. Which is the longest train in India?
- jansadharan exp
 - shivganga express
 - duronto
 - prayagraj express
115. Which is the slowest train in India?
- Nilgri Express
 - vivek express
 - shram shaktyi exp
 - mahamana express
116. Name the application launched by Reliance communication for international calling.
- RCT Abroad
 - RSI India
 - RGC India
 - JIO Global
117. Where was the 17th annual Latin Grammy Awards held ?
- Florida
 - Las Vegas
 - Mexico
 - New Jersey
118. Scientists has genetically modified photosynthesis process to increase crop yield by
- 11 Percent
 - 12 Percent
 - 15 Percent
 - 17 Percent
119. Which player has been sentenced 8-year ban By NADA?
- Dharambir Singh
 - Narsingh Yadav
 - Rahul Bhatnagar
 - Mr. M. Syamlal
120. The 6th edition of 'Kathakar: International Storytellers Festival' was held in _____
- Mumbai
 - Hyderabad
 - Kolkata
 - New Delhi

Hints & Explanations

1. (a) Let the number be z . Now $385 = 5 \times 7 \times 11$

5	z	Remainders
7	y	4
11	x	6
	102	10

$$x = 11 \times 102 + 10 = 1132$$

$$y = 7x + 6 = 7 \times 1132 + 6 = 7930$$

$$z = 5y + 4 = 5 \times 7930 + 4 = 39654$$

2. (b) Divisor = [Sum of remainders]
 - [Remainder when sum is divided]
 $= 11 + 21 - 4 = 28$
3. (c) Let C.P. = ₹ 100. Then M.P. = ₹ 120 and S.P. = ₹ 108

$$\% \text{ discount} = \left(\frac{12}{120} \times 100 \right) \% = 10\%$$

4. (a) Let the sum invested in Scheme A be ₹ x and that in Scheme B be ₹ $(13900 - x)$.
 Then,

$$\left(\frac{x \times 14 \times 2}{100} \right) - \left[\frac{(13900 - x) \times 11 \times 2}{100} \right] = 3508$$

$$\Rightarrow 28x - 22x = 350800 - (13900 \times 22)$$

$$\Rightarrow 6x = 45000$$

$$\Rightarrow x = 7500.$$

$$\text{So, sum invested in Scheme B} = ₹ (13900 - 7500) = ₹ 6400.$$

5. (b) Required difference = $\frac{PR^2}{(100)^2}$

$$\Rightarrow \frac{4000 \times 5 \times 5}{100 \times 100} = ₹ 10$$

6. (c) Let the profit = x

$$\text{Profit of A} = \frac{9x}{10}, \text{ Remaining profit} = \frac{x}{10}$$

$$\text{Profit of B} = \frac{x}{20}$$

$$\text{Profit of C} = \frac{x}{20}$$

$$\text{Ratio of profit} = \frac{9}{10} : \frac{1}{20} : \frac{1}{20} \\ = 18 : 1 : 1$$

A's income is increased by ₹ 270. When profit rises 3%

$$\text{Investment of A} = \frac{270}{3} \times 100 = ₹ 9000.$$

If investment of A, B and C = $18x$, x and x
 $18x = 9000$

$$x = 500$$

B's investment = ₹ 500.

C's investment = ₹ 500.

7. (d) $(P + Q + R)$'s 1 hour's work =

$$\left(\frac{1}{8} + \frac{1}{10} + \frac{1}{12} \right) \times \frac{37}{120}$$

Work done by P, Q and R in 2 hours =

$$\left(\frac{37}{120} \times 2 \right) = \frac{37}{60}$$

$$\text{Remaining work} = \left(1 - \frac{37}{60} \right) = \frac{23}{60}$$

$(Q + R)$'s 1 hour's work

$$= \left(\frac{1}{10} + \frac{1}{12} \right) = \frac{11}{60}$$

Now, $\frac{11}{60}$ work is done by Q and R in 1 hour.

So, $\frac{23}{60}$ work will be done by Q and R in

$$\left(\frac{60}{11} \times \frac{23}{60} \right) = \frac{23}{11} \text{ hours} \approx 2 \text{ hours.}$$

So, the work will be finished approximately 2 hours after 11 a.m., i.e., around 1 p.m.

8. (a) Let the length of the journey = x km.
 \therefore Journey rides by horse cart

$$= x \left(1 - \frac{1}{2} - \frac{1}{3} \right) = \frac{1}{6}x \text{ km.}$$

Then, total time taken to complete journey

$$\frac{31}{5} \text{ hr}$$

$$\Rightarrow t_1 + t_2 + t_3 = \frac{31}{5}$$

$$\Rightarrow \frac{x}{2} \times \frac{1}{4} + \frac{x}{3} \times \frac{1}{12} + \frac{x}{6 \times 9} = \frac{31}{5}$$

$$\Rightarrow x = \frac{31}{5} \times \frac{216}{37} = 36.2 \text{ km} \approx 36 \text{ km}$$

9. (a) $x^2 + y^2 + 2x + 1 = 0$
 $\Rightarrow x^2 + 2x + 1 + y^2 = 0$
 $\Rightarrow (x+1)^2 + y^2 = 0$
 $\Rightarrow x+1=0 \Rightarrow -1$ and $y=0$
 $\therefore x^{31} + y^{35} = -1$

10. (a) $2^x = 3^y = 6^{-z} = k$
 $\Rightarrow 2 = k^{\frac{1}{x}}; 3 = k^{\frac{1}{y}}; 6 = k^{\frac{1}{z}}$
 $\therefore 2 \times 3 = 6$

$\Rightarrow k^{\frac{1}{x}} \times k^{\frac{1}{y}} = k^{\frac{1}{z}} \Rightarrow k^{\frac{1}{x} + \frac{1}{y}} = k^{\frac{1}{z}}$
 $\Rightarrow \frac{1}{x} + \frac{1}{y} = \frac{1}{z} \Rightarrow \frac{1}{x} + \frac{1}{y} - \frac{1}{z} = 0$

11. (c) $m \frac{1}{m-2} = 4$
 $m^2 - 6m + 9 = 0$
 $(m-3)(m-3) = 0$
 $m = 3$
 $m - 2 = 1$

Now $(m-2)^2 + \frac{1}{m-2} = 2$
 $= 1^2 + \frac{1}{1} = 2$

12. (b) In $\triangle AOB$
 $AO = BO$ (radii of circles)
 $\therefore \angle ABO = \angle BAO = 30^\circ$
 In $\triangle BOC$

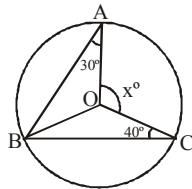

$BO = CO$ (radii of circles)
 $\therefore \angle BCO = \angle OBC = 40^\circ$
 $\angle ABC = \angle ABO + \angle OBC$
 $\angle ABC = 30^\circ + 40^\circ = 70^\circ$
 $2 \times \angle ABC = \angle AOC \Rightarrow x^\circ = 140$

13. (d) $\angle MBA = 180^\circ - 95^\circ = 85^\circ$
 $\angle AMB = \angle TMN$... (Same angles with different names)
 $\therefore \triangle MBA \sim \triangle MNT$ (AA test for similarity)

$\frac{MB}{MN} = \frac{AB}{NT}$ (proportional sides)

$\frac{10}{MN} = \frac{5}{9} \therefore MN = \frac{90}{5} = 18.$

14. (b)

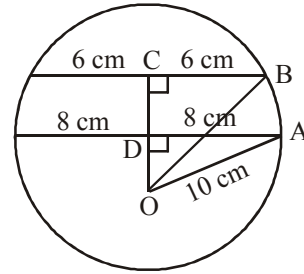

In $\triangle ADO$,
 $OD = \sqrt{(AO)^2 - AD^2}$
 $= \sqrt{100\text{cm}^2 - 64\text{cm}^2} = 6\text{ cm}$

In $\triangle BCO$,
 $OC = \sqrt{OB^2 - CB^2}$
 $= \sqrt{100\text{cm}^2 - 36\text{cm}^2} = 8\text{ cm}$
 Distance between chords = $OC - OD = 2\text{ cm}$

15. (a) In $\triangle ABC$, $DE \parallel BC$
 By applying Basic Proportionality

theorem, $\frac{AD}{DB} = \frac{AE}{EC}$

But $\frac{AD}{DB} = \frac{3}{5}$ (Given)

$\therefore \frac{AE}{EC} = \frac{3}{5}$ or $\frac{AE}{EC} = \frac{3}{5}$ or

$\frac{AE}{AC} = \frac{3}{8}$

or $\frac{AE}{5.6} = \frac{3}{8} \Rightarrow 8AE = 3 \times 5.6 \Rightarrow AE = 3 \times \frac{5.6}{8}$
 $\therefore AE = 2.1\text{ cm}.$

16. (a) $AO = \sqrt{OQ^2 - AQ^2} = \sqrt{5^2 - 4^2} = \sqrt{9} = 3$
 Now, from similar \triangle s QAO and QOR
 $OR = 2OA = 2 \times 3 = 6\text{ cm}.$

17. (d) $\frac{1}{2}[4 - (2 \ 16) \ 3(-16 - 4) \ 3(4 \ 2)]$
 $= \frac{1}{2}[56 - 60 + 18] = 7$

18. (a) $(\sin \theta + \cos \theta)^2 + (\sin \theta - \cos \theta)^2$
 $= (\sin^2 \theta + \cos^2 \theta) + 2 \sin \theta \cdot \cos \theta + (\sin^2 \theta + \cos^2 \theta) - 2 \sin \theta \cdot \cos \theta.$
 $= 1 + 1 = 2$
 So, $(\sin \theta + \cos \theta)^2 + (\sin \theta - \cos \theta)^2 = 2$

- or, $(\sin \theta + \cos \theta)^2 + \left(\frac{7}{13}\right)^2 = 2$
- or, $(\sin \theta - \cos \theta)^2 = 2 - \frac{49}{169} = \frac{289}{169}$
- $\sin \theta + \cos \theta = \sqrt{\left(\frac{17}{13}\right)^2} = \frac{17}{13}$
19. (a) $\frac{x \times 2^2 \cdot (\sqrt{2})^2}{8 \times \left(\frac{1}{\sqrt{2}}\right)^2 \times \left(\frac{\sqrt{3}}{2}\right)^2} = (\sqrt{3})^2 - \left(\frac{1}{\sqrt{3}}\right)^2$
- or, $\frac{x \times 4 \times 2}{8 \times \frac{1}{2} \times \frac{3}{4}} = 3 - \frac{1}{3} \Rightarrow \frac{8x}{3} = \frac{9-1}{3}$
- or, $\frac{8}{3}x = \frac{8}{3}$
- $x = 1$
20. (a) $\sin \theta = \cos (2\theta - 45^\circ)$
or, $\cos (90^\circ - \theta) = \cos (2\theta - 45^\circ)$
 $\Rightarrow 90^\circ - \theta = 2\theta - 45^\circ$
 $\Rightarrow \theta = 45^\circ$
 $\therefore \tan \theta = \tan 45^\circ = 1$
21. (d) Total number of students studying B.Sc. in all the colleges together
 $= 350 + 325 + 300 + 375 + 425$
 $= 1775$
22. (c) Total number of students studying B.Sc. in colleges C and E
 $= 300 + 425 = 725$
Total number of students studying B.A. in colleges A and B
 $= 275 + 300 = 575$
 \therefore Required ratio $= 725 : 575$
 $= 29 : 23$
23. (a) Total number of students studying in different streams in all the colleges:
B.Sc. $\rightarrow 1775$
B.A. $\rightarrow 275 + 300 + 325 + 450 + 325 = 1675$
B.Com. $\rightarrow 425 + 475 + 325 + 425 + 225 = 1875$
 \therefore Required ratio
 $= 1775 : 1675 : 1875$
 $= 71 : 67 : 75$
24. (a) Volume of the bucket = volume of the sand emptied
Volume of sand $= \pi (21)^2 \times 36$
- Let r be the radius of the conical heap.
- Then, $\frac{1}{3} \pi r^2 \times 12 = \pi (21)^2 \times 36$
- or $r^2 = (21)^2 \times 9$ or $r = 21 \times 3 = 63$
25. (c) Volume of the liquid in the cylindrical vessel
 $=$ Volume of the conical vessel
 $= \left(\frac{1}{3} \times \frac{22}{7} \times 12 \times 12 \times 50\right) \text{cm}^3$
 $= \left(\frac{22 \times 4 \times 12 \times 50}{7}\right) \text{cm}^3$
- Let the height of the liquid in the vessel be h .
- Then, $\frac{22}{7} \times 10 \times 10 \times h = \frac{22 \times 4 \times 12 \times 50}{7}$
- or $h = \left(\frac{4 \times 12 \times 50}{10 \times 10}\right) = 24 \text{ cm}$
26. (c) Let the numbers be $17x$ and $45x$ respectively. According to the question.
- $\frac{1}{5}$ of $45x - \frac{1}{3}$ of $17x = 15$
- $\Rightarrow 9x - \frac{17x}{3} = 15$
- $\Rightarrow \frac{27x - 17x}{3} = 15 \Rightarrow 10x = 15 \times 3$
- $\Rightarrow x = \frac{15 \times 3}{10} = \frac{9}{2}$
- \therefore The required number
 $= 17x = \frac{17 \times 9}{2} = \frac{153}{2} = 76\frac{1}{2}$
27. (a) Given exp. $\sqrt{10 \sqrt{25 \sqrt{108 \sqrt{154} 15}}}$
- $= \sqrt{10 \sqrt{25 \sqrt{108 \sqrt{169}}}}$
- $= \sqrt{10 \sqrt{25 \sqrt{108} 13}} = \sqrt{10 \sqrt{25 \sqrt{121}}}$
- $= \sqrt{10 \sqrt{25 \cdot 11}} = \sqrt{10 \sqrt{36}} = \sqrt{10 \cdot 6} = \sqrt{60} = 4$
28. (b) Let x be the remainder, then the numbers $(55 - x)$, $(127 - x)$ and $(175 - x)$ are exactly divisible by the required number. Now, we know that if two numbers are divisible by a certain number, then their difference is also divisible by the number. Hence the numbers $(127 - x) - (55 - x)$, $(175 - x) - (127 - x)$ and $(175 - x) - (55 - x)$ or, 72 , 48 and 120 are divisible by the required number. HCF of 48 , 72 and $120 = 24$, therefore the required number $= 24$.

$$29. (b) \frac{16 \times 28 \frac{1}{4} - 2 \times 58}{14} = 24$$

30. (b) Let profit per litre = ₹ 20
So, C.P./litre = ₹ 100
S.P./litre = ₹ 120
On adding 10% water to the milk

$$\text{C.P. per } \frac{9}{10} \text{ litre} = ₹ 100$$

$$\text{S.P. per } \frac{9}{10} \text{ litre} = ₹ 120$$

$$\text{S.P. per litre} = ₹ \frac{120 \times 10}{9} = ₹ \frac{400}{3}$$

$$\Rightarrow \text{Profit/litre} = \frac{400}{3} - 100 = 33.33$$

$$\% \text{ by which profit increases} = 33.33 - 20 = 13.3$$

$$31. (b) \text{ Let } \frac{a}{3} = \frac{b}{4} = \frac{c}{7} = k.$$

$$a = 3k, b = 4k, c = 7k$$

$$\therefore \frac{a}{c} = \frac{b}{c} \Rightarrow \frac{3k}{7k} = \frac{4k}{7k} = \frac{7k}{7k} = \frac{14k}{7k} = \frac{2}{1} \text{ or } 2:1$$

32. (a) Work done by A and B in 5 days =

$$\left(\frac{1}{10} + \frac{1}{15} \right) \times 5 = \frac{5}{6}$$

$$\text{Work remaining} = 1 - \frac{5}{6} = \frac{1}{6}$$

$$\therefore \text{C alone can do the work in } 6 \times 2 = 12 \text{ days}$$

Ratio of their share work

$$= \frac{5}{10} : \frac{5}{15} : \frac{2}{12} = 3 : 2 : 1$$

$$\text{Share of wages} = \text{Rs } 225, \text{ Rs } 150, \text{ Rs } 75.$$

33. (a) Due to stoppages, it covers 20 km less.

$$\text{Time taken to cover } 20 \text{ km} = \frac{20}{80} \text{ h} = \frac{1}{4} \text{ h}$$

$$= \frac{1}{4} \times 60 \text{ min} = 15 \text{ min}$$

34. (b) Area of the inner curved surface of the well dug

$$= [2\pi \times 3.5 \times 22.5] = 2 \times \frac{22}{7} \times 3.5 \times 22.5$$

$$= 44 \times 0.5 \times 22.5 = 495 \text{ sq. m.}$$

$$\therefore \text{Total cost} = 495 \times 3 = ₹ 1485.$$

35. (d) Let C.P. = Rs x. Then

$$S.P_1 - S.P_2 = ₹ 6$$

$$\frac{(100 - 10)x}{100} - \frac{(100 - 8)x}{100} = 6$$

$$\Rightarrow 110x - 108x = 600 \Rightarrow 2x = 600 \Rightarrow x = ₹ 300$$

36. (c) Suppose pipe A alone takes x hours to fill the tank.

Then, pipes B and C will take $\frac{x}{2}$ and $\frac{x}{4}$ hours respectively to fill the tank.

$$\therefore \frac{1}{x} + \frac{2}{x} + \frac{4}{x} = \frac{1}{5} \Rightarrow \frac{7}{x} = \frac{1}{5} \Rightarrow x = 35 \text{ hrs.}$$

37. (b) Let the length of the bridge be x m.

$$\text{Now, } (x + 100) = 72 \times 25 \times \frac{5}{18} = 500$$

$$\Rightarrow x = 500 - 100 = 400 \text{ m}$$

38. (c) $x^2 + y^2 + z^2 = xy + yz + zx$

Multiply both sides by 2.

$$\therefore 2(x^2 + y^2 + z^2)$$

$$= 2(xy + yz + zx)$$

$$\Rightarrow 2x^2 + 2y^2 + 2z^2 - 2xy - 2yz - 2zx = 0$$

$$\Rightarrow (x - y)^2 + (y - z)^2 + (z - x)^2 = 0$$

$$\Rightarrow x - y = 0 \Rightarrow x = y$$

$$y - z = 0 \Rightarrow y = z$$

$$z - x = 0 \Rightarrow z = x$$

$$\therefore \frac{4x + 2y - 3z}{2x} = \frac{4 + 2 - 3}{2} = \frac{3}{2}$$

39. (a) $x + \frac{1}{x} = \sqrt{3}$

Cubing both sides,

$$x^3 + \frac{1}{x^3} - 3\left(x + \frac{1}{x}\right) = \sqrt{3}^3$$

$$\Rightarrow x^3 + \frac{1}{x^3} - 3\sqrt{3} = 3\sqrt{3} \Rightarrow x^3 + \frac{1}{x^3} = 6\sqrt{3}$$

$$\text{Now, } x^{18} + x^{12} + x^6 + 1$$

$$= x^{12}(x^6 + 1) + 1(x^6 + 1) = (x^{12} + 1)(x^6 + 1)$$

$$= (x^{12} + 1) \cdot x^3 \left(x^3 + \frac{1}{x^3} \right) = 0$$

40. (c) $\sin \theta + \sqrt{\sin \theta + \sqrt{\sin \theta + \sqrt{\sin \theta + \dots}}}$

$$= \sec^4 \alpha = y^2 \text{ (say)} \quad \dots(i)$$

Then, $y = \sqrt{\sin \theta + \sqrt{\sin \theta + \sqrt{\sin \theta + \dots \infty}}}$

Squaring on both sides, we get

$y^2 = \sin \theta + y$

$\Rightarrow y^2 - y = \sin \theta$ or $y(y - 1) = \sin \theta$

$\Rightarrow \sec^2 \alpha (\sec^2 \alpha - 1) = \sin \theta$

[from Eq. (i), $y = \sec^2 \alpha$]

$\Rightarrow \sin \theta = \sec^2 \alpha \tan^2 \alpha$

41. (c) The words in each pair are synonyms.

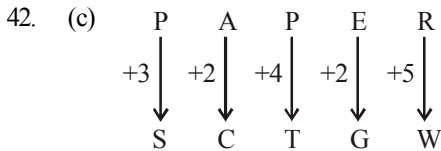

Similarly,

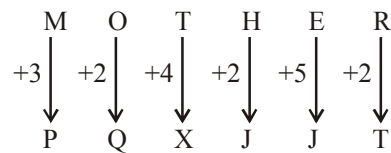

43. (a) $210 = (15)^2 - 15$
 $380 = (20)^2 - 20$] $15 + 5 = 20$

$182 = (14)^2 - 14$
 $(19)^2 - 19 = 342$] $14 + 5$

44. (d)

45. (b) Pattern is-

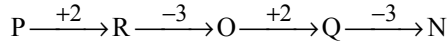

So that, DECEG is out.

46. (a) Only 117-143 is divisible by 13. Therefore, it is odd one out.

47. (d)

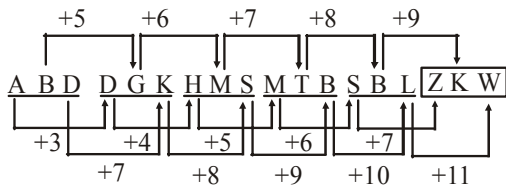

48. (d) Each number is 15 multiplied by a prime number i.e. $15 \times 11, 15 \times 13, 15 \times 17, 15 \times 19, 15 \times 23, \dots$

So, missing term = $15 \times 29 = 435$.

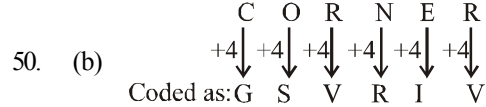
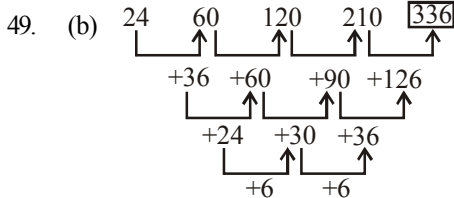

Similarly,

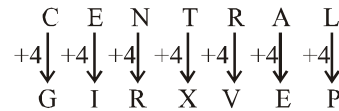

51. (b)
- | | | | |
|----|----|----|---|
| L | O | V | E |
| | | | |
| 12 | 15 | 22 | 5 |
- $12 + 15 + 22 + 5 = 54$

$\frac{54}{2} = 27$

Similarly,

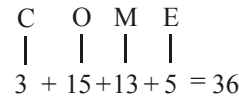

$\frac{36}{2} = 18$

52. (d) A is the sister of B and B is the son/daughter of C. So, A is the daughter of C. Also, D is the father of C. Thus, A is the granddaughter of D.

53. (c)

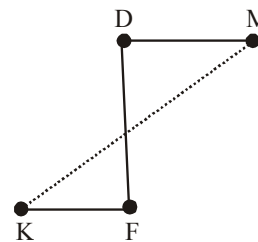
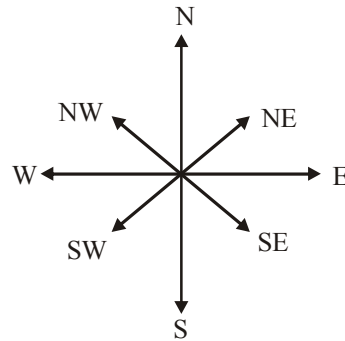

M is to the North-East of K.

54. (b) If the first working day happened to be Tuesday then 8th, 15th, 22nd and 29th of the month will be Tuesday. Hence, the last day of the month will be Wednesday (since,

number of days in the month is 30). Thus, the next casual leave will be on Thursday.

55. (b)

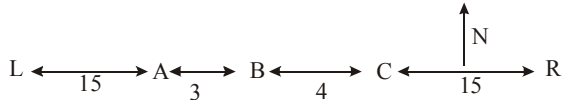

Clearly, according to the given conditions, there are 15 boys to the left of A, as well as to the right of C. Also, B lies between A and C such that there are 3 boys between A and B and 4 boys between B and C. So, number of boys in the row

$$= (15 + 1 + 3 + 1 + 4 + 1 + 15) = 40.$$

56. (c)

Total students
 = [Malay's place from starting + Malay's place from end] - 1
 = [13 + 17] - 1 = 29
 Number of passed students
 = [Malay's place from starting + Malay's place from end] - 1
 = [8 + 13] - 1 = 20
 \therefore Number of failed students = 29 - 20 = 9

57. (b)

$$5 \times 3 + 1 = 16; 9 \times 3 + 2 = 29;$$

$$16 \times 3 + 1 = 49; 29 \times 3 + 2 = 89;$$

$$15 \times 3 + 3 = 48; 48 \times 3 + 3 = 147.$$

58. (b)

$$(7 + 9 + 5 + 4) \times 2 - 10 = 40$$

$$(17 + 8 + 3 + 6) \times 2 - 14 = 54$$

$$(10 + 21 + 6 + 3) \times 2 - 18 = 62$$

59. (d)

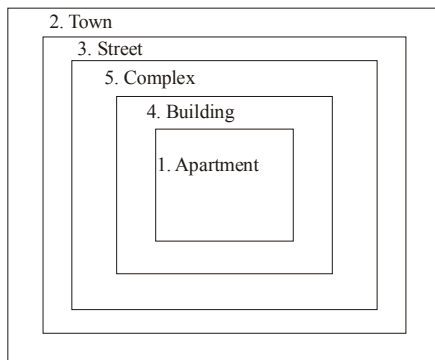

60. (c)

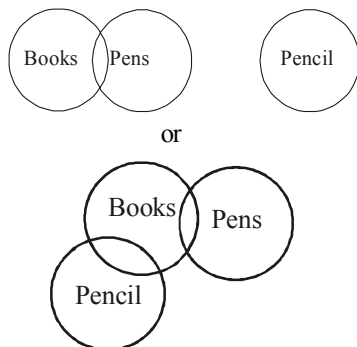

Conclusions:

- I. False
- II. False

Hence, either I, II follows

61. (a)

Solve by options, we can check all the options one by one.
 $25 \div 5 \times 20 + 27 - 7 \Rightarrow 5 \times 20 + 27 - 7$
 $\Rightarrow 100 + 27 - 7$
 $120 = 120$

62. (d)

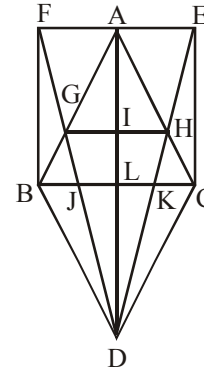

$\triangle FDE, \triangle ACD, \triangle ABD,$
 $\triangle FBD, \triangle ABC, \triangle BCD,$
 $\triangle BKD, \triangle BLD, \triangle BJD,$
 $\triangle JCD, \triangle JKD, \triangle LDJ, \triangle LCD,$
 $\triangle LKD, \triangle HDC, \triangle KDC, \triangle EDC,$
 $\triangle HKC, \triangle EKC, \triangle AEC, \triangle EHC,$
 $\triangle AEH, \triangle AGH, \triangle AIH, \triangle AGI,$
 $\triangle AFB, \triangle AGF, \triangle FBG$
 \therefore Total 28 triangles.

63. (b)

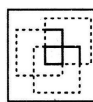

64. (a)

The water image of 'a' is 'g', 'b' is 'p', 'S' is 'Z', 'e' is 'e', 'n' is 'u', 'c' is 'c' and 'e' is 'e'.

65. (b)

1 dot in rect and circle. One dot in train n circle, so only 4th figure can have these 2 dots

66. (d)

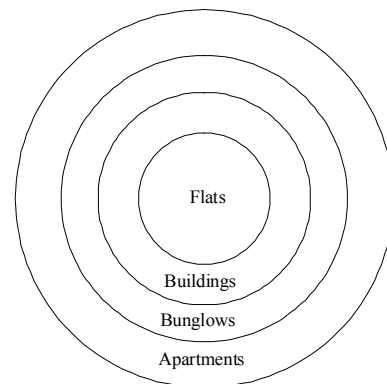

Hence conclusions I. ✓ II. ✓ III. ✓

67. (b)

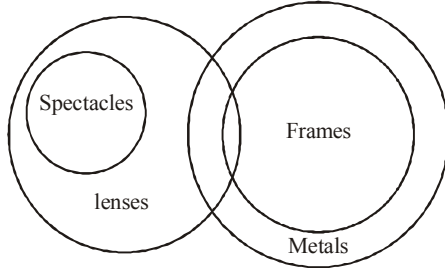

Hence, conclusions I. ✓ II. ✗ III. ✗

68. (d) 5 1 4 7 3 9 8 5 7 **2** 6 3 1 5

8 6 3 8 5 2 3 4 3 4 9 6

69. (d) Except cube, all other have flat surface.
 70. (a) Letter e represents the typists who are only graduates but not Government employees.
 71. (b) Letter g represent the typists who are only Government employees but not graduates
 72. (d) Given

1	3	4	7	9	2	5	6	8
A	Q	F	J	L	D	M	P	N

From the above table, 396824 is coded as:

Thus,

3	9	6	8	2	4
Q	L	P	N	D	F

73. (a) Given,

O	V	E	R	V	I	S	T
\$	#	%	*	#	+	×	-

From the above table, SORE is coded as :

S	O	R	E
×	\$	*	%

74. (c) The sister of one's mother is one's maternal aunt. Hence, the man is the husband of the boy's maternal aunt.

(Qs. 75-77):

Sitting Arrangement:

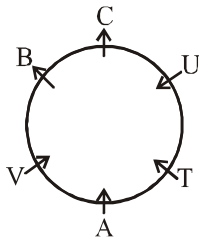

75. (c) B and C are not facing centre.
 76. (d) The position of T in respect of B is third to the left or right.
 77. (c) The position of V in respect of C is fourth to the right.
 78. (c) S is the 3rd letter after P and W is the 3rd letter after T. Similarly D & H are the 3rd letters after A and E respectively.
 79. (c) Clearly the 2 middle alphabets follow next letter sequence, MN, QR and UV. So (c) is odd.

80. (a)

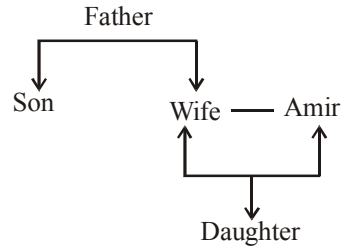

Amir's daughter mother i.e. Amir's wife
 Amir's wife's father's son (Manjeet) i.e. brother of Amir's wife hence Manjeet is Amir's brother in law.

81. (a) 82. (d) 83. (a) 84. (a) 85. (b)
 86. (a) 87. (c) 88. (b) 89. (b) 90. (d)
 91. (c) 92. (d) 93. (b) 94. (c) 95. (c)
 96. (a) 97. (c) 98. (a) 99. (d) 100. (a)
 101. (a) 102. (d) 103. (d) 104. (a) 105. (c)
 106. (d) 107. (d) 108. (b) 109. (d) 110. (b)
 111. (b) 112. (b) 113. (c) 114. (c) 115. (a)
 116. (c) 117. (b) 118. (c)
 119. (a) Dharambir Singh a Haryana sprinter, who was recently barred from representing the country in the Rio Olympics at the last minute for failing a dope test, has been sentenced a ban of eight years by the National Anti-Doping Agency (NADA).
 120. (d)

ARITHMETIC

DIRECTIONS (Q. 1-3) : What should come in place of the question mark(?) in the following questions?

- $\sqrt{?} - 11 = \sqrt{1521}$
 (a) $\sqrt{2500}$ (b) $(28)^2$
 (c) $\sqrt{28}$ (d) None of these
- $588 \times 563 \div 540 = 519 \times ? \div 483 \times 468$
 (a) 500 (b) 496
 (c) 494 (d) 490
- $121 \times ? \div 81 \times 64 \div 49 \times 36 \div 25$
 (a) 92 (b) 114
 (c) 98 (d) 100
- The sum of 15% of a positive number and 10% of the same number is 70. What is twice of that number?
 (a) 440 (b) 280
 (c) 560 (d) 140
- Vikram scored 72 per cent marks in five subjects together, viz; Hindi, Science, Maths, English and Sanskrit together, where in the maximum marks of each subject were 100. How many marks did Vikram score in Science if he scored 80 marks in Hindi, 70 marks in Sanskrit, 76 marks in Maths and 65 marks in English?
 (a) 72 (b) 69
 (c) 59 (d) 71
- The respective ratio between Pooja's, Prarthana's and Falguni's monthly income is 53:70: 57. If Prarthana's annual income is ₹4,20,000, what is the sum of Pooja's and Falguni's annual incomes? (In some cases monthly income and in some cases annual income is used.)
 (a) ₹ 5,92,500 (b) ₹ 6,83,500
 (c) ₹ 6,60,000 (d) ₹ 7,79,200
- Manhar sold an item for ₹ 8,400 and incurred a loss of 25%. At what price should he have sold the item to have gained a profit of 40%?
 (a) ₹ 15,680 (b) ₹ 16,220
 (c) ₹ 14,540 (d) Cannot be determined
- What will come in place of both the question marks (?) in the following question?
 $\frac{?^{2.3}}{8} = \frac{2}{?^{1.7}}$
 (a) 8 (b) 1 (c) 4 (d) 2
- What would be the simple interest accrued in 4 years on a principal of ₹16,500 at the rate of 16 p.c.p.a.?
 (a) ₹ 11,560 (b) ₹ 10,250
 (c) ₹ 12,500 (d) ₹ 10,560
- A truck covers a distance of 360 km in 8 hours. A car covers the same distance in 6 hours. What is the respective ratio between the speed of the truck and the car?
 (a) 3 : 5 (b) 3 : 4
 (c) 1 : 2 (d) 4 : 5
- In order to pass in an exam a student is required to get 975 marks out of the aggregate marks. Priya got 870 marks and was declared failed by 7 per cent. What are the maximum aggregate marks a student can get in the examination?
 (a) 1500 (b) 1000
 (c) 1200 (d) Cannot be determined
- The average of four consecutive numbers A, B, C and D respectively is 56.5. What is the product of A and C?
 (a) 3363 (b) 3306
 (c) 3192 (d) None of these
- Parag walks 226 metres everyday. How many kilometres will he walk in five weeks?
 (a) 6.57 (b) 7.91
 (c) 8.23 (d) 9.41
- On children's day sweets were to be equally distributed amongst 200 children. But on that particular day 40 children remained absent; hence each child got 2 sweets extra. How many sweets were distributed?
 (a) 3000 (b) 1500
 (c) 2000 (d) 1600

15. The perimeter of a square is one-fourth the perimeter of a rectangle. If the perimeter of the square is 44 cm and the length of the rectangle is 51 cm, what is the difference between the breadth of the rectangle and the side of the square?
 (a) 30 cm (b) 18 cm (c) 26 cm (d) 32 cm
16. What is the difference between the compound interest and simple interest accrued on an amount of ₹12,000 at the end of three years at the rate of 12%?
 (a) ₹ 539.136 (b) ₹ 602.242
 (c) ₹ 495.248 (d) ₹ 488.322
17. The area of a rectangle is equal to the area of a circle with circumference equal to 220 metres. What is the length of the rectangle if its breadth is 50 metres?
 (a) 56 metres (b) 83 metres
 (c) 77 metres (d) 69 metres
18. Prashant incurred a loss of 75 per cent on selling an article for ₹ 6,800. What was the cost price of the article?
 (a) ₹ 27,700 (b) ₹ 25,600
 (c) ₹ 21,250 (d) ₹ 27,200
19. The average age of a man and his son is 16 years. The ratio of their ages is 15 : 1 respectively. What is the son's age?
 (a) 30 years (b) 32 years
 (c) 2 years (d) 4 years
20. The length, breadth and height of a cuboid are in the ratio 1 : 2 : 3. The length, breadth and height of the cuboid are increased by 100%, 200% and 200%, respectively. Then, the increase in the volume of the cuboid will be :
 (a) 5 times (b) 6 times
 (c) 12 times (d) 17 times
21. If $3x = a + b + c$, then the value of $(x - a)^3 + (x - b)^3 + (x - c)^3 - 3(x - a)(x - b)(x - c)$ is
 (a) $a + b + c$
 (b) $(a - b)(b - c)(c - a)$
 (c) 0
 (d) None of these
22. The value of x satisfying the equation $\sqrt{2x+3} + \sqrt{2x-1} = 2$, is :
 (a) 3 (b) 2 (c) 1 (d) $\frac{1}{2}$
23. If $\frac{x^2}{by+cz} = \frac{y^2}{cz+ax} = \frac{z^2}{ax+by} = 1$, then the value of $\frac{a}{a+x} + \frac{b}{b+y} + \frac{c}{c+z}$ is
 (a) -1 (b) 2 (c) 1 (d) -2
24. If $x^2 + \frac{1}{x^2} = 38$ then find the value of $x - \frac{1}{x}$.
 (a) +6 (b) -6 (c) ± 6 (d) ± 9
25. Find the distance of the intersection point of x -axis and the line $5x + 9y = 45$ from origin.
 (a) 5 (b) 9 (c) $\frac{5}{9}$ (d) $\frac{9}{5}$
26. The middle term of arithmetic series 3, 7, 11...147, is
 (a) 71 (b) 75 (c) 79 (d) 83
27. If P is a point in the interior of a circle with centre O and radius r , then
 (a) $OP = r$ (b) $OP > r$
 (c) $OP \geq r$ (d) $OP < r$
28. With the vertices of $\triangle ABC$ as centres, three circles are described each touching the other two externally. If the sides of the triangle are 4, 6 and 8 cm, respectively, then the sum of the radii of the three circles equals :
 (a) 10 (b) 14 (c) 12 (d) 9
29. The radius of a circle is 13 cm and xy is a chord which is at a distance of 12 cm from the centre. The length of the chord is
 (a) 12 cm (b) 10 cm (c) 20 cm (d) 15 cm
30. Find the greatest number of 4 digits which, when divided by 2, 3, 4, 5, 6 and 7, should leave remainder 1 in each case.
 (a) 9661 (b) 9671 (c) 9695 (d) 9696
31. Two trains 100 metres and 120 metres long are running in the same direction with speeds of 72 km/h and 54 km/h. In how much time will the first train cross the second?
 (a) 50 sec (b) 44 sec (c) 38 sec (d) 42 sec
32. If $x \cos 60^\circ + y \cos 0^\circ = 3$ and $4x \sin 30^\circ - y \cot 45^\circ = 2$, what is the value of x ?
 (a) -1 (b) 0 (c) 1 (d) 2
33. If $\cos \theta \geq \frac{1}{2}$ in the first quadrant, which one of the following is correct?
 (a) $\theta \leq \frac{\pi}{3}$ (b) $\theta \geq \frac{\pi}{3}$
 (c) $\theta \leq \frac{\pi}{6}$ (d) $\theta \geq \frac{\pi}{6}$
34. If $\tan A = \frac{1 - \cos B}{\sin B}$, what is $\frac{2 \tan A}{1 - \tan^2 A}$ equal to?
 (a) $\tan \frac{B}{2}$ (b) $2 \tan B$
 (c) $\tan B$ (d) $4 \tan B$

35. If $x = a(1 + \cos \theta \cos \phi)$, $y = b(1 + \cos \theta \sin \phi)$ and $z = c(1 + \sin \theta)$, then which one of the following is correct?

(a) $\left(\frac{x-a}{a}\right)^2 + \left(\frac{y-b}{b}\right)^2 + \left(\frac{z-c}{c}\right)^2 = 1$

(b) $\frac{x^2}{a^2} + \frac{y^2}{b^2} + \frac{z^2}{c^2} = 1$

(c) $x^2 + y^2 + z^2 = a^2 + b^2 + c^2$

(d) $\frac{(x-a)^2}{a} + \frac{(y-b)^2}{b} + \frac{(z-c)^2}{c} = 1$

36. If $A = \cos x \cos y$, $B = \sin x \sin y$ and $C = \sin^2 x \sin^2 y$, what is the value of $A^2 - B^2$?

- (a) C (b) $1 - C$ (c) $1 + C$ (d) $C - 1$
37. From a horizontal distance of 50 m, the angles of elevation of the top and the bottom of a vertical cliff face are 45° and 30° respectively. The height of the cliff face (in metres) is :

(a) $\frac{50}{\sqrt{3}}$ (b) $\frac{50}{\sqrt{2}}$

(c) $\frac{50}{2\sqrt{3}}$ (d) $50\left(1 - \frac{1}{\sqrt{3}}\right)$

DIRECTIONS (Qs.38-40): Study the following table to answer the given questions:

Percentage of marks obtained by seven students in six subjects

Subject (Max, Marks ↓ Students)	Eng	His	Com	Math	Science	Econ
	(100)	(100)	(100)	(100)	(100)	(100)
Meera	100	80	50	90	90	60
Subodh	80	70	80	100	80	40
Kunal	90	70	60	90	70	70
Soni	60	60	65	80	80	80
Richu	50	90	62	80	85	95
Irene	40	60	64	70	65	85
Vgay	80	80	35	65	50	75

38. What is the total marks obtained by Meera in all the subject?
- (a) 448 (b) 580 (c) 470 (d) 74.67
39. What is the average marks obtained by these seven students in History? (rounded off to two digits)
- (a) 72.86 (b) 27.32 (c) 24.86 (d) 29.14
40. How many students have got 60% or more marks in all the subjects?
- (a) One (b) Two
(c) Three (d) Four

GENERAL INTELLIGENCE & REASONING

DIRECTIONS (Qs. 41-42): In each of the following questions, select the related word/letters/number from the given alternatives :

41. Coconut : Shell :: Letter : ?
(a) Letter-box (b) Stamp
(c) Mail (d) Envelope
42. Commodore : Navy :: Brigadier : ?
(a) Captain (b) Commander
(c) Air force (d) Army

DIRECTIONS (Qs. 43-44): In each of the following questions, four words have been given, out of which three are alike in some manner and the fourth one is different. Choose out the odd one.

43. (a) Malaria (b) Plague
(c) Dengue (d) Tetanus
44. (a) Polyester (b) Cotton
(c) Terylene (d) Nylon

DIRECTIONS (Qs. 45-46) : A series is given with one/two term(s) missing. Choose the correct alternative from the given ones that will complete the series.

45. AJKTU, BILSV, CHMRW, DGNQX, ?
(a) FEOYZ (b) EFOPY
(c) EOFZA (d) EFOPZ
46. hgf, kji, n ??
(a) lp (b) up
(c) oq (d) ml

DIRECTIONS (Qs. 47-48): A series is given with one/two term(s) missing. Choose the correct alternative from the given ones that will complete the series.

47. 1, 2, 8, 33, 148, ?
(a) 265 (b) 465
(c) 565 (d) 765
48. 18,, 22, 21, 20, 24, 18, ?
(a) 27 (b) 25
(c) 16 (d) 28

DIRECTIONS (Qs. 49-50) : In the series of terms given in each of the questions below, identify the term which does not fit in the series.

49. 1 C V, 5 F U, 9 I T, 15 L S, 17 O R
(a) 9 J T (b) 15 L S
(c) 5 F U (d) 17 O R
50. B 0 R, G 3 U, E 3 P, J 7 S, H 9 N
(a) E 3 P (b) H 9 A
(c) J 7 S (d) G 3 U

51. If LOSE is coded as 1357 and GAIN is coded as 2468, what do the figures 84615 stand for?
 (a) NAILS (b) SNAIL
 (c) LANES (d) SLAIN
52. If DANCE is coded as GXQZH then how will RIGHT be coded?
 (a) UFJEW (b) SGKFX
 (c) UFJWE (d) UFWJE
53. B is D's mother and C is D's brother. H is E's daughter whose wife is D. How are E and C related?
 (a) Father-in-law (b) Brother-in-law
 (c) Uncle (d) Brother
54. Sita is the niece of Ashok. Ashok's mother is Lakshmi. Kalyani is Lakshmi's mother. Kalyani's husband is Gopal. Parvathi is the mother-in-law of Gopal. How is Sita related to Gopal?
 (a) Great grandson's daughter
 (b) Gopal is Sita's father
 (c) Sita is Gopal's great granddaughter.
 (d) Grand niece.
55. A man starts from a point and walks 2 km towards north. He turns right and walks 3 km. Then he turns left and travels 2 km. What is the direction he is now facing?
 (a) East (b) West (c) South (d) North
56. Kamu walks 5 kms straight from her house towards west, then turns right and walks 3 kms. Thereafter she takes left turn and walks 2 km. Further, she turns left and walks 3 km. Finally, she turns right and walks 3 kms. In what direction she is now from her house?
 (a) West (b) North (c) South (d) East
57. Five men A, B, C, D and E read a newspaper. The one who reads first gives it to C, the one who reads last had taken it from A. E was not the first or last to read. There were two readers between B and A. Find the person who read the newspaper last.
 (a) E (b) B (c) D (d) E
58. There are five friends – S, K, M, A, R. S is shorter than K, but taller than R. M is the tallest. A is a little shorter than K and little taller than S. Who has two persons taller and two persons shorter than him?
 (a) R (b) S (c) K (d) A
59. From the given alternatives select the word which **cannot** be formed using the letters of the given word.
 QUINTESSENCE
 (a) Essence (b) Entice
 (c) Sequin (d) Question
60. Rearrange the given jumbled letters to make a meaningful word.
 Given letters : riytaraplmen
 (a) Lamination (b) Realignment
 (c) Parliamentary (d) Replacement
61. Arrange the following words according to the dictionary:
 1. Matter 2. Motive
 3. Mockery 4. Manage
 5. Movies
 (a) 4, 1, 2, 5, 3 (b) 4, 2, 3, 5, 1
 (c) 3, 2, 1, 4, 5 (d) 4, 1, 3, 2, 5
62. Which one of the given responses would be a meaningful order of the following?
 1. Plant 2. Thread
 3. Seed 4. Shirt
 5. Cotton
 (a) 3, 1, 2, 5, 4 (b) 3, 1, 5, 2, 4
 (c) 1, 3, 2, 4, 5 (d) 1, 3, 2, 5, 4
63. Hari remembers that his father's birthday is between 13th and 16th of June, whereas his sister remembers that their father's birthday is between 14th and 18th of June. On which day is their father's birthday, which both agree?
 (a) 14th June (b) 15th June
 (c) 16th June (d) 17th June
64. The day before the day before yesterday is three days after Saturday. What day is it today?
 (a) Thursday (b) Friday
 (c) Tuesday (d) Wednesday
65. If 9th of the month falls on the day preceding Sunday, on what day will 1st of the month fall?
 (a) Friday (b) Saturday
 (c) Sunday (d) Monday
66. If the day before yesterday was Thursday, when will Sunday be?
 (a) Tomorrow
 (b) Day after tomorrow
 (c) Today
 (d) Two days after today
67. Choose the diagram which represents the relationship among the following:
 Capsules: Antibiotics : Injections

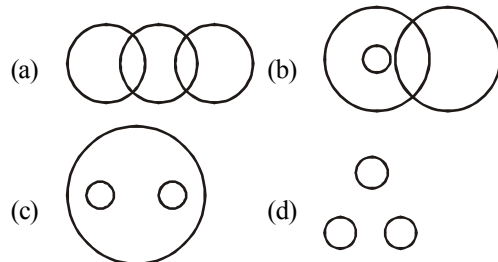

68. In a survey, 70% of those surveyed owned a car and 75% of those surveyed owned a TV. If 55% owned both a car and a TV, what percent of those surveyed did not own either a car or a TV?
 (a) 25% (b) 20% (c) 10% (d) 5%

DIRECTIONS (Qs. 69-70) : In each of the following question, one, two or more statements are given followed by conclusion I, II or more. You have to consider the statements to be true, even if they seem to be at variance from commonly known facts. You are to decide which of the given conclusions definitely follows from the given statements.

69. Statements:

1. All poets are intelligent.
2. All singers are intelligent.

Conclusions:

- I. All singers are poets.
 - II. Some intelligent persons are not singers.
- (a) Only conclusion I follows.
 (b) Only conclusion II follows.
 (c) Either conclusion I or II follows.
 (d) Neither conclusion I nor II follows.

70. Statements:

1. All students are boys.
2. No boy is dull.

Conclusions:

- I. There are no girls in the class.
 - II. No student is dull.
- (a) Only conclusion I follows.
 (b) Only conclusion II follows.
 (c) Both conclusions I and II follows.
 (d) Neither conclusion I nor conclusion II follows.

71. Select the correct equation after interchanging operations and numbers as given below \times and $+$; 12 and 16

- (a) $(60 \div 16) \times 14 = 70$
 (b) $(55 - 12) + 3 = 42$
 (c) $(40 \times 8) - 12 = 36$
 (d) $(36 + 10) \div 16 = 30$

72. Some equations are solved on the basis of a certain system. For the same basis, find the correct answer for the unsolved equation. If $837 = 452$ and $106 = 769$, then $708 \div 77 = ?$

- (a) 9 (b) 10 (c) 11 (d) 12

73. One-third of Ramesh's marks in Arithmetic is equal to half his marks in English. If he gets 150 marks in the two subjects together, how many marks has he got in English?

- (a) 60 (b) 120
 (c) 30 (d) 50

74. My age is two years less than twice that of my brother. If I am sixteen years old, how old is my brother?

- (a) 7 years (b) 9 years
 (c) 10 years (d) 14 years

DIRECTIONS (Qs. 75) : A word is represented by only one set of numbers as given in any one of the alternatives. The sets of numbers given in the alternatives are represented by two classes of alphabets as shown in two matrices given below. The columns and rows of Matrix I are numbered from 0 to 4 and that of Matrix II are numbered from 5 to 9. A letter from these matrices can be represented first by its row and next by its column, e.g.

75. 'H' can be represented by 14, 20, 42, etc. and 'D' can be represented by 59, 65, 86, etc. Identify the set for the word NAIL.

MATRIX-I

	0	1	2	3	4
0	R	H	E	L	I
1	I	E	L	R	H
2	H	L	R	I	E
3	E	R	I	H	L
4	L	I	H	E	R

MATRIX-II

	5	6	7	8	9
5	B	S	N	A	D
6	D	N	B	S	A
7	A	B	D	N	S
8	S	D	A	B	N
9	N	A	S	D	B

- (a) 57, 87, 01, 43 (b) 59, 58, 10, 12
 (c) 89, 57, 04, 41 (d) 95, 87, 32, 21

76. Study the following figures and find out the number opposite to 3.

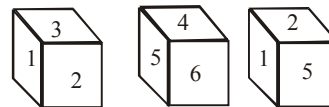

- (a) 6 (b) 4
 (c) 5 (d) 2

77. How many triangles are there in the given diagram?

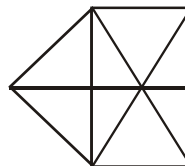

- (a) 18 (b) 17
 (c) 16 (d) 15

78. Among the four answer figures, which figure can be formed from the cut-pieces given below in the question figure?

Question Figure:



Answer Figure:

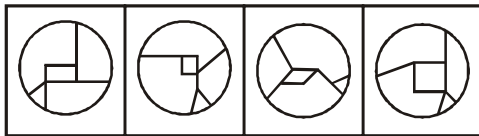

(a) (b) (c) (d)

DIRECTION (Q.79-80) : In each of the following questions a set of three figures 1, 2 and 3 showing a sequence of folding of a piece of paper. Fig. (3) shows the manner in which the folded paper has been cut. These three figures are followed by four answer figures from which you have to choose a figure which would most closely resemble the unfolded form of fig. (3).

79.

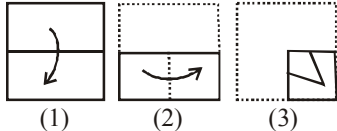

(1) (2) (3)

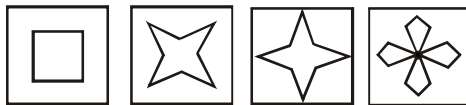

(a) (b) (c) (d)

80. What comes next in the sequence

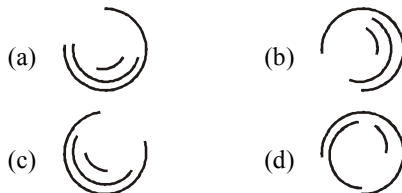

GENERAL AWARENESS

81. When you cut or copy information it gets place in the

- (a) Clipart
- (b) Clipboard
- (c) Internet
- (d) Motherboard

- 82. Secondary storage
 - (a) does not require constant power
 - (b) does not use magnetic media
 - (c) consists of four main types of devices
 - (d) None of the above
- 83. A device that provides emergency power to your computer, conditions the voltage, and protects against powers surges is called a
 - (a) PSU= Power Supply Unit
 - (b) USP= Universal Surge Protector
 - (c) UPPS = Universal Power Protection and Supply
 - (d) UPS = Uninterruptible Power Supply
- 84. Deleted data remains on a disk until
 - (a) the data is overwritten
 - (b) the recycle bin is emptied
 - (c) a file compression utility is used
 - (d) the disk is scanned
- 85. Output which is made up of pictures, sounds, and video is called
 - (a) COM
 - (b) hard copy
 - (c) graphics
 - (d) multimedia
- 86. A satellite in vacuum -
 - (a) is kept in orbit by remote control
 - (b) is kept in orbit by retro-rocket
 - (c) derives energy from gravitational field
 - (d) does not require any energy for orbiting
- 87. The nuclear force is -
 - (a) Short range repulsive force
 - (b) Short range attractive force
 - (c) Long range repulsive force
 - (d) Long range attractive force
- 88. The required DC voltage for arc welding is -
 - (a) 6 to 9 V
 - (b) 50 to 60 V
 - (c) 200 to 250 V
 - (d) 90 to 100 V
- 89. For a body floating in water, the apparent weight is equal to -
 - (a) Actual weight of the body
 - (b) Zero
 - (c) Weight of the body minus weight of the liquid
 - (d) Weight of the body plus upward thrust
- 90. The colour code of 47k $\Omega \pm 20\%$ resistor will be
 - (a) Orange, Blue, Yellow, Silver
 - (b) Yellow, Violet, Orange
 - (c) Yellow, Violet, Orange, Silver
 - (d) Yellow, Violet, Orange, Gold

91. An amplifier is said to suffer from distortion when its output is
 (a) low
 (b) different from input
 (c) noisy
 (d) larger than its input
92. Sound in TV is modulating -
 (a) AM (b) FM
 (c) PCM (d) PM
93. The spacing between picture carrier and sound carrier frequency in T.V. is -
 (a) 7 MHZ (b) 5.5 MHZ
 (c) 5 MHZ (d) None of these
94. The threshold frequency is the frequency below which -
 (a) photo current is constant
 (b) photo current increases with voltage
 (c) photo current decreases with voltage
 (d) photo electric emission is not possible
95. The damage of the human body due to radiation (χ -rays or γ -rays etc.) is measured in -
 (a) Rads (b) Rems
 (c) Roentgen (d) Curie
96. The mass number of a nucleus is
 (a) always less than its atomic number
 (b) the sum of the number of protons and neutrons present in the nucleus
 (c) always more than the atomic weight
 (d) a fraction
97. The inexpensive and commonly used variety of glass is called soda glass. It is called so because
 (a) was used initially for making bottles of soda (carbonated drink)
 (b) is made using soda(sodium carbonate)
 (c) was initially used for storing sodium carbonate
 (d) is made using soda lime
98. The nucleus of an atom consists of
 (a) electrons and neutrons
 (b) electrons and protons
 (c) protons and neutrons
 (d) All of the above
99. Jatak stories are written in ancient language.
 (a) Sanskrit (b) Brahmi
 (c) Greek (d) Pali
100. Who among the following is the Head of Indian Republic?
 (a) Prime Minister
 (b) President
 (c) Speaker of Lok Sabha
 (d) Vice-President
101. On which of the following dates was the Indian Constitution approved by the Constituent Assembly?
 (a) November 26, 1949 (b) January 26, 1950
 (c) August 15, 1947 (d) January 30, 1948
102. Which countries take part in Commonwealth games?
 (a) All the countries of the world
 (b) The countries which had been under British rule
 (c) Countries of Asian-Pacific region
 (d) Developing nations
103. Vishwanathan Anand is associated with which of the following games?
 (a) Snooker (b) Billiards
 (c) Chess (d) Ice-Hockey
104. What is the full form of 'http' ?
 (a) Hypo Test Transfer Protocol
 (b) Hyper Text Transfer Protocol
 (c) Hyper Test Transfer Proxy
 (d) None of these
105. If a firm is operating at loss in the short-period in perfect combination. it should;
 (a) decrease the production and the price.
 (b) increase the production and the price
 (c) continue to operate as long as it covers even the variable costs.
 (d) shut-down and leave the industry
106. For which one of the following commissions, there is no provision in the Indian Constitution?
 (a) Election Commission
 (b) Finance Commission
 (c) Planning Commission
 (d) Union Public Service Commission
107. According to some archaeologists, the structure of Lothal indicates to be which of the following?
 (a) Fort (b) Dockyard
 (c) Public building (d) Great tank
108. Consultants of liquefied petroleum gas are-
 (a) Butane and Propane
 (b) Ethane and Hexane
 (c) Ethane and Nonane
 (d) Butane and Nonane
109. Which Sultan received a robe of honour from the caliph?
 (a) Ala-ud-din Khilji
 (b) Iltutmish
 (c) Balban
 (d) Qutub-ud-din Albak

110. Symbolic sign of rupees is the combination of Roman and scripts.
 (a) Devnagari (b) Tamil
 (c) Telugu (d) Gurumukhi
111. Which of the following denotes on-coming generation of computers with Artificial Intelligence?
 (a) Pentium II
 (b) Linux
 (c) iPod
 (d) Fifth Generation Computers
112. 'Rajtarangini' is considered as an authentic book on history of India. The author of this book was
 (a) Banbhata (b) Ravikirti
 (c) Pushpadanta (d) Kalhan
113. On which route is the longest railway tunnel of about 6.5 km situated?
 (a) Central Railway
 (b) Konkan Railway
 (c) Southern Railway
 (d) Western Railway
114. Who is the first woman railway driver?
 (a) Rajashree Sachdev
 (b) Bhavani Kumari
 (c) Ritu Chauhan
 (d) Surekha Yadav
115. Name the luxury train launched by the Indian Railways to celebrate the country's 50 years of independence.
 (a) Rajdhani Express
 (b) Swarna Shatabdi
 (c) Golden Globe Express
 (d) Azadi Express
116. Under 'Housing for All by 2022', Government has approved setting up of how many houses in the next three years?
 (a) 1.5 Crore (b) 1 Crore
 (c) 2.5 Crore (d) 1.25 Crore
117. Recently which state has been adopted by Sachin Tendulkar under the Sansad Adarsh Gram Yojna?
 (a) Gollapalli village
 (b) Ulavapadu village
 (c) Buddapalli village
 (d) Inkollu village
118. Which of the following was declared as the word of the year 2016 by Oxford Dictionaries ?
 (a) Post-truth (b) Woke
 (c) Adulthood (d) Hygge
119. Which among the following Broadcaster service will launch 11 new language services?
 (a) NBC (b) CBS
 (c) ABC (d) BBC
120. India's First and Asia's longest cycle highway has been opened in which states of India ?
 (a) Uttar pradesh (b) Andhra pradesh
 (c) Odisha (d) Assam

Hints & Explanations

1. (d) $\sqrt{?} - 11 = \sqrt{1521}$
 $\Rightarrow \sqrt{?} - 11 = 39$
 $\Rightarrow \sqrt{?} = 39 + 11 = 50$
 $\therefore ? = (50)^2 = 2500$
2. (a) Given series.
- | | | | | | | |
|------|------|------|------|------|------|-----|
| 588 | 563 | 540 | 519 | 500 | 483 | 468 |
| | | | | | | |
| ↑ | ↑ | ↑ | ↑ | ↑ | ↑ | ↑ |
| - 25 | - 23 | - 21 | - 19 | - 17 | - 15 | |
- $\therefore ? = 500$
3. (d) Given series.
- | | | | | | | |
|----------|----------|---------|---------|---------|---------|---------|
| 121 | 100 | 81 | 64 | 49 | 36 | 25 |
| ↑ | ↑ | ↑ | ↑ | ↑ | ↑ | ↑ |
| $(11)^2$ | $(10)^2$ | $(9)^2$ | $(8)^2$ | $(7)^2$ | $(6)^2$ | $(5)^2$ |
- $\therefore ? = 100$
4. (c) Let the positive no. be x .
According to question. 15% of x + 10% of $x = 70$
- $$\Rightarrow x \times \frac{15}{100} + \frac{x \times 10}{100} = 70$$
- $$\Rightarrow \frac{15x}{100} + \frac{10x}{100} = 70$$
- $$\Rightarrow \frac{25x}{100} = 70$$
- $$\therefore x = \frac{70 \times 100}{25} = 280$$
- \therefore Double of given no. = $280 \times 2 = 560$
5. (b) Total number obtained by Vikram
- $$= (100 \times 5) \times \frac{72}{100} = 500 \times \frac{72}{100} = 360$$
- \therefore Number in science
 $= 360 - (80 + 70 + 76 + 65) = 360 - 291 = 69$
6. (c) Monthly income of Prarthana's
- $$= \frac{4,20,000}{12} = ₹ 35,000 \text{ Monthly income of Pooja and Falgunis}$$
- $= 35,000 \times \frac{53+57}{70} = 35,000 \times \frac{110}{70} = ₹ 55,000$
- \therefore Annual income of Pooja and Falgunis
 $= 55,000 \times 12 = ₹ 6,60,000$
7. (a) Cost price of item.
- $$= 8400 \times \frac{100}{100-25} = 8400 \times \frac{100}{75} = ₹ 11200$$
- SP of item
- $$= 11200 \times \frac{100+40}{100} = 11200 \times \frac{140}{100} = ₹ 15680$$
8. (d) $\frac{(?)^{2.3}}{8} = \frac{2}{(?)^{1.7}}$
- $$\Rightarrow (?)^{2.3+1.7} = 16 \Rightarrow (?)^4 = 16 = (2)^4$$
- $\therefore ? = 2$
9. (d) Simple interest
- $$a = \frac{\text{principle} \times \text{time} \times \text{rate}}{100} = \frac{16500 \times 4 \times 16}{100} = ₹ 10560$$
10. (b) Speed of truck
- $$= \frac{\text{distance}}{\text{time}} = \frac{360}{8} = 45 \text{ km/hr}$$
- Speed of car
- $$= \frac{\text{distance}}{\text{time}} = \frac{360}{6} = 60 \text{ km/hr}$$
- \therefore Ratio = $45 : 60 = 3 : 4$
11. (a) Minimum marks to pass = 975
Priya failed by $975 - 870 = 105$ marks
- \therefore Maximum mark = $\frac{105}{7} \times 100 = 1500$
12. (d) Let four consecutive numbers are
 $A = (x)$, $B = (x+1)$, $C = (x+2)$ and
 $D = (x+3)$
- According to question
- $$\text{Average} = \frac{(x) + (x+1) + (x+2) + (x+3)}{4}$$

$$\Rightarrow 56.5 = \frac{4x+6}{4}$$

$$\Rightarrow 226 = 4x+6$$

$$\Rightarrow 4x = 226 - 6 = 220 \quad \therefore$$

$$x = \frac{220}{4} = 55$$

\therefore Product of A and C

$$= (x) \times (x+2) = (55) \times (55+2) = 55 \times 57 = 3135$$

13. (b) Required distance

$$= 226 \times (5 \times 7) = 226 \times 35 = 7910 \text{ m} = 7.91 \text{ km}$$

14. (d) Let x sweets is distributed to each children
According to question

$$(200 - 40) \times (x + 2) = 200 \times x$$

$$\Rightarrow (160) \times (x + 2) = 200x$$

$$\Rightarrow 160x + 320 = 200x$$

$$\Rightarrow 200x - 160x = 320 \Rightarrow 40x = 320$$

$$\therefore x = \frac{320}{40} = 8$$

$$\therefore \text{Total no. of sweets} \\ = 200 \times x = 200 \times 8 = 1600$$

15. (c) One side of square = $\frac{\text{circumference}}{4}$

$$= \frac{44}{4} = 11 \text{ cm}$$

Circumference of rectangle = $4 \times$ perimeter

of square

$$= 4 \times 44 = 176 \text{ cm}$$

width of rectangle

$$= \frac{\text{circumference of rectangle}}{2} - \text{length}$$

$$= \frac{176}{2} - 51 = 88 - 51 = 37 \text{ cm.}$$

$$\therefore \text{Required difference} = \text{width} - \text{side} = 37 - 11 \\ = 26 \text{ cm.}$$

16. (a) S.I. = $\frac{\text{principal} \times \text{time} \times \text{rate}}{100}$

$$= \frac{12000 \times 3 \times 12}{100} = ₹ 4320$$

$$\text{C.I.} = P \left[\left(1 + \frac{\text{rate}}{100} \right)^{\text{time}} - 1 \right]$$

$$= 12000 \left[\left(1 + \frac{12}{100} \right)^3 - 1 \right]$$

$$= 12000 \left[\left(\frac{28}{25} \right)^3 - 1 \right]$$

$$= 12000 \left[\frac{21952}{15625} - 1 \right] = 12000 \times \frac{6327}{15625}$$

$$= ₹ 4859.136$$

$$\therefore \text{Required difference} = 4859.136 - 4320 \\ = ₹ 539.136$$

17. (c) Radius of circle

$$(r) = \frac{\text{circumference}}{2\pi} = \frac{220 \times 7}{2 \times 22} = 35 \text{ m.}$$

area of circle

$$= \pi r^2 = \frac{22}{7} \times (35)^2 = \frac{22}{7} \times 35 \times 35$$

$$= 3850 \text{ m}^2 = \text{area of rectangle}$$

\therefore Length of rectangle

$$= \frac{\text{area of rectangle}}{\text{width}}$$

$$= \frac{3850}{50} = 77 \text{ m.}$$

18. (d) CP of article

$$= 6800 \times \frac{100}{100 - 75} = 6800 \times \frac{100}{25} = ₹ 27200$$

19. (c) Let the age of father and son be $15x$ years and x years respectively.

Now, according to the question,

$$\frac{15x + x}{2} = 16$$

$$\text{or, } x = \frac{16 \times 2}{16} = 2 \text{ years}$$

Hence age of the son = 2 years

20. (d) Let the length, breadth and height of the cuboid be x , $2x$ and $3x$, respectively.

$$\text{Therefore, volume} = x \times 2x \times 3x = 6x^3$$

New length, breadth and height = $2x$, $6x$ and $9x$, respectively.

New volume = $108x^3$
 Thus, increase in volume = $(108 - 6)x^3 = 102x^3$

$$\frac{\text{Increase in volume}}{\text{Original volume}} = \frac{102x^3}{6x^3} = 17$$

21. (c)

22. (d) The given equation is

$$\sqrt{2x+3} + \sqrt{2x-1} = 2.$$

Substituting the values of x from the given

options, we find that $x = \frac{1}{2}$ satisfies the equation.

23. (c) $\frac{x^2}{by+cz} = 1$

$$\Rightarrow x^2 = by + cz$$

Adding term ax on both sides

$$\Rightarrow x^2 + ax = ax + by + cz$$

$$\Rightarrow x(x+a) = ax + by + cz$$

$$\Rightarrow \frac{1}{x+a} = \frac{x}{ax+by+cz}$$

$$\Rightarrow \frac{a}{x+a} = \frac{ax}{ax+by+cz}$$

Similarly,

$$\frac{b}{b+y} = \frac{by}{ax+by+cz}$$

$$\frac{c}{c+z} = \frac{cz}{ax+by+cz}$$

$$\therefore \frac{a}{x+a} + \frac{b}{y+b} + \frac{c}{z+c}$$

$$= \frac{ax}{ax+by+cz} + \frac{by}{ax+by+cz} + \frac{cz}{ax+by+cz}$$

$$= \frac{ax+by+cz}{ax+by+cz} = 1$$

24. (c) $\therefore \left(x - \frac{1}{x}\right)^2 = x^2 + \frac{1}{x^2} - 2 \times \frac{1}{x} \times x = 38 - 2 = 36$

$$\therefore \left(x - \frac{1}{x}\right) = \pm \sqrt{36} = \pm 6$$

25. (b) We know that, $y = 0$ on x-axis \therefore Putting $y = 0$ in the line $5x + 9y = 45$

$$\Rightarrow 5x = 45 \Rightarrow x = 9$$

Now, distance between $(9, 0)$ and $(0, 0) = 9$

26. (b) 3, 7, 11 147

It is an arithmetic series whose

first term, $a = 3$ last term, $x_n = 147$ common difference, $d = 4$

$$x_n = a + (n-1)d$$

$$147 = 3 + (n-1) \times 4$$

$$n-1 = \frac{147-3}{4}$$

$$n-1 = 36, n = 37$$

The given series consists of 37 terms.

Therefore, its middle term will be

$$\frac{37+1}{2} = 19\text{th term}$$

$$x_{19} = 3 + (19-1)4$$

$$= 3 + 18 \times 4 = 75$$

 \therefore The middle term of the given arithmetic series is 75.27. (d) $OP < r$

28. (d)

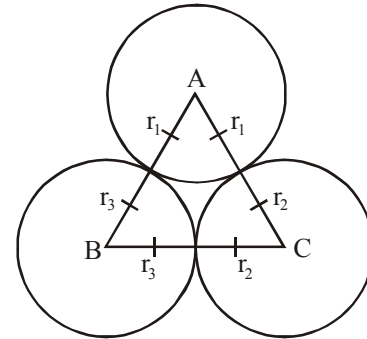

$$r_1 + r_2 = 4, r_2 + r_3 = 6 \text{ and } r_3 + r_1 = 8$$

$$\Rightarrow 2(r_1 + r_2 + r_3) = 18$$

$$\text{or } r_1 + r_2 + r_3 = 9 \text{ cm}$$

29. (b) From figure,

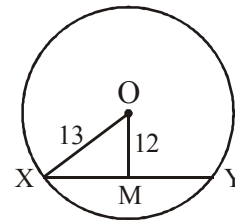

$$XM = \sqrt{13^2 - 12^2}$$

$$= \sqrt{169 - 144} = 5$$

 \therefore Length of the chord = $2 \times XM$

$$= 2 \times 5 = 10 \text{ cm}$$

30. (a) The greatest number of 4 digits = 9999. LCM of 2, 3, 4, 5, 6, 7 = 420
On dividing 9999 by 420, we get 339 as remainder.

\therefore the greatest number of 4 digits which is divisible by 2, 3, 4, 5, 6 and 7 = $9999 - 339 = 9660$

\therefore the required number = $9660 + 1 = 9661$

31. (b) Relative speed of the trains
= $(72 - 54)$ km/h = 18 km/h

$$= \left(18 \times \frac{5}{18}\right) \text{ m/sec} = 5 \text{ m/sec.}$$

Time taken by the trains to cross each other
= Time taken to cover (100 + 120) m at 5 m/sec

$$= \left(\frac{220}{5}\right) \text{ sec} = 44 \text{ sec.}$$

32. (d) We have, $x \cos 60^\circ + y \cos 0^\circ = 3$

$$x \times \frac{1}{2} + y \times 1 = 3 \quad \frac{x}{2} + y = 3$$

$$x + 2y = 6 \quad \dots(i)$$

$$\text{and } 4x \sin 30^\circ - y \cot 45^\circ = 2$$

$$4x \times \frac{1}{2} - y \times 1 = 2 \quad 2x - y = 2 \quad \dots(ii)$$

On multiplying by 2 in Eq. (ii) and adding to Eq. (i), we get

$$x + 2y = 6$$

$$4x - 2y = 4$$

$$5x = 10$$

$$x = 2$$

33. (a) $\cos \theta \geq \frac{1}{2}$ means the value of θ lies

between 0° and $\frac{\pi}{3}$.

\therefore θ is less than or equal to $\frac{\pi}{3}$, i.e., $\theta \leq \frac{\pi}{3}$.

34. (c)

$$\frac{2 \tan A}{1 - \tan^2 A} = \tan 2A = \frac{1 - \cos 2B}{\sin 2B} = \frac{1 - (1 - 2 \sin^2 B)}{2 \sin B \cos B}$$

$$\left[\begin{array}{l} \because \cos 2B = 1 - 2 \sin^2 B \\ \text{and } \sin 2B = 2 \sin B \cos B \end{array} \right] = \frac{\sin B}{\cos B} = \tan B$$

35. (a) $x = a(1 + \cos \theta \cos \phi) = \frac{x}{a} - 1 = \cos \theta \cos \phi$
... (i)

$$y = b(1 + \cos \theta \sin \phi) = \frac{y}{b} - 1 = \cos \theta \sin \phi$$

... (ii)

$$\text{and } z = c(1 + \sin \theta) = \frac{z}{c} - 1 = \sin \theta \quad \dots(iii)$$

On squaring and adding Eqs. (i), (ii) and (iii), we get

$$\left(\frac{x-a}{a}\right)^2 + \left(\frac{y-b}{b}\right)^2 + \left(\frac{z-c}{c}\right)^2$$

$$= \cos^2 \theta (\cos^2 \phi + \sin^2 \phi) + \sin^2 \theta = 1$$

36. (b) $A^2 - B^2 = \cos^2 x \cdot \cos^2 y - \sin^2 x \cdot \sin^2 y$

$$= (\cos x \cdot \cos y + \sin x \cdot \sin y)$$

$$(\cos x \cdot \cos y - \sin x \cdot \sin y)$$

$$= \cos(x-y) \cdot \cos(x+y)$$

$$= \cos^2 x - \sin^2 y = 1 - \sin^2 x - \sin^2 y$$

$$= 1 - (\sin^2 x + \sin^2 y) = 1 - C$$

37. (d) Let the height of cliff face AD be h metres

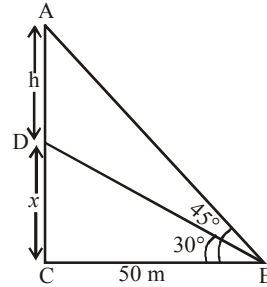

$$\text{In } \triangle DCB, \tan 30^\circ = \frac{x}{50}$$

$$\text{or } \frac{1}{\sqrt{3}} = \frac{x}{50} \quad \text{or } x = \frac{50}{\sqrt{3}}$$

... (i)

$$\text{In } \triangle ACB, \tan 45^\circ = \frac{(x+h)}{50} \quad \text{or } x+h=50$$

... (ii)

$$\text{From (ii) and (i), we get, } h = 50 - \frac{50}{\sqrt{3}}$$

$$= 50 \left(1 - \frac{1}{\sqrt{3}}\right) \text{ m}$$

38. (c) Total marks obtained by Meera
= $100 + 80 + 50 + 90 + 90 + 60 = 470$

39. (a) Average marks obtained by seven students in History

$$= \frac{80 + 70 + 70 + 60 + 90 + 60 + 80}{7} = 72.86$$

40. (b) Only Kunal and Soni got 60% or more marks in all the subjects.
 41. (d) First is enclosed inside the second.
 42. (d) Commodore is a rank in Navy, while Brigadier is an equivalent rank in Army.
 43. (d) All except Tetanus are diseases
 44. (b) All except cotton are synthetic fibres and cotton is a natural fibre

45. (b) $A \xrightarrow{+1} B \xrightarrow{+1} C \xrightarrow{+1} D \xrightarrow{+1} E$
 $J \xrightarrow{-1} I \xrightarrow{-1} H \xrightarrow{-1} G \xrightarrow{-1} F$
 $K \xrightarrow{+1} L \xrightarrow{+1} M \xrightarrow{+1} N \xrightarrow{+1} O$
 $T \xrightarrow{-1} S \xrightarrow{-1} R \xrightarrow{-1} Q \xrightarrow{-1} P$
 $U \xrightarrow{+1} V \xrightarrow{+1} W \xrightarrow{+1} X \xrightarrow{+1} Y$

46. (d) $h \xrightarrow{+3} k \xrightarrow{+3} n$
 $g \xrightarrow{+3} j \xrightarrow{+3} m$
 $f \xrightarrow{+3} i \xrightarrow{+3} l$

47. (d) $1 \times 1 + (1)^2 = 1 + 1 = 2;$
 $2 \times 2 + (2)^2 = 4 + 4 = 8;$
 $8 \times 3 + (3)^2 = 24 + 9 = 33;$
 $33 \times 4 + (4)^2 = 132 + 16 = 148;$

$$148 \times 5 + (5)^2 = 740 + 25 = \boxed{765}$$

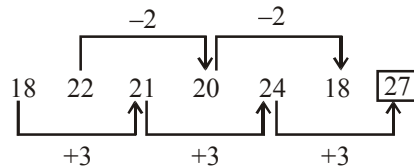
48. (a) 

49. (b) The numerical parts moves with a difference of + 4.
 Thus, the correct sequence of the numerical components would be 1, 5, 9, 13, 17 Therefore, 15 LS does not fit in the series.

50. (c) There are two series :
 I. B0R E3P H9N
 First letter moves + 3 steps forward. The middle numerical component moves + 3, + 6, + 9 and the letter in the third

position moves 2 steps backwards (- 2).
 II. G3U, J7S
 The same pattern follows in this series.
 Hence, J7S does not fit.

51. (a)

L	O	S	E		G	A	I	N
↓	↓	↓	↓		↓	↓	↓	↓
1	3	5	7		2	4	6	8

 Therefore,

8	4	6	1	5
↓	↓	↓	↓	↓
N	A	I	L	S

52. (a)
 53. (b) E is the husband of D.
 C is the brother of D.
 Therefore, C is the brother-in-law of E.
 54. (c) Sita is granddaughter of Lakshmi.
 Gopal is father of Lakshmi.
 Therefore, Sita is great grand daughter of Gopal.

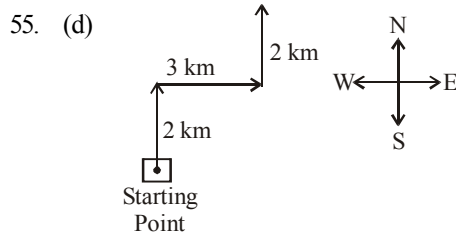

Clearly, he is facing towards north.

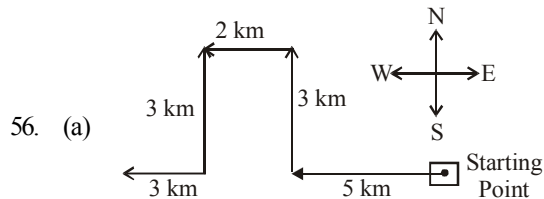

It is clear from the diagram that Kamu is to the west of her house.

57. (c) According to question,

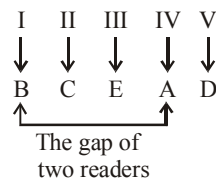

Therefore, D read the newspaper in the last.

58. (d) $K > S > R$... (i)
 $K > A > S$... (ii)
 M is the tallest ... (iii)
 From the statements (i), (ii) and (iii)
 $M > K > \boxed{A} > S > R$

59. (d) There is no 'O' letter in the keyword.
 60. (c) Parliamentary
 61. (d) Arrangement of words according to dictionary:

4. Manage
 ↓
 1. Matter
 ↓
 3. Mockery
 ↓
 2. Motive
 ↓
 5. Movies

62. (b) Meaningful order of the words:

3. Seed
 ↓
 1. Plant
 ↓
 5. Cotton
 ↓
 2. Thread
 ↓
 4. Shirt

63. (b) According to Hari, his father's birthday may be on 14th or 15th June.
 According to Hari's sister, their father's birthday may be on 15th, 16th or 17th June.
 Common Date \Rightarrow 15th June
64. (b) Three days after Saturday = Tuesday
 The day before the day before Yesterday \Rightarrow Tuesday
 Today = Tuesday + 3 = Friday
65. (a) According to question,
 9th \rightarrow Saturday
 Therefore, $9 - 7$
 = 2nd \rightarrow Saturday
 \therefore 1st \rightarrow Friday
66. (a) Day before yesterday was Thursday.
 Today is Saturday.
 Tomorrow will be Sunday.
67. (c) Capsules are different from Injections. But, both are used as antibiotics.

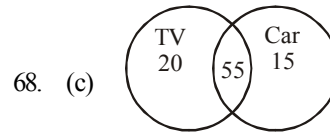
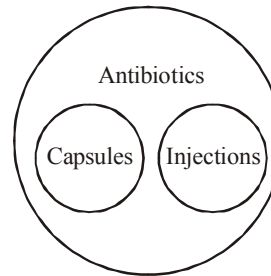

Per cent of those surveyed who did not own either a car or a TV
 $= 100 - (20 + 55 + 15)$
 $= 100 - 90 = 10\%$

69. (d) Both the Premises are Universal Affirmative (A-type). These two Premises are not aligned. Now take the Converse of one of the Premises to align them.

All singers are intelligent.

Some intelligent are poets.

A + I \Rightarrow No Conclusion.

70. (b) First Premise is Universal Affirmative and the second Premise is Universal Negative (E-type).

All students are boys.

No boys is dull

A + E \Rightarrow E-type of Conclusion

"No student is dull"

This is conclusion II.

71. (d) $(60 \div 16) \times 14 = 70$
 $\Rightarrow (60 \div 12) + 14 = 70$
 $\Rightarrow 5 + 14 \neq 70$
 $(55 + 12) + 3 = 42$
 $\Rightarrow (55 - 16) \times 3 = 42$
 $\Rightarrow 39 \times 3 \neq 42$
 $(40 \times 8) - 12 = 36$
 $\Rightarrow (40 \times 8) - 16 = 36$
 $\Rightarrow 48 - 16 = 36$
 $\Rightarrow 32 \neq 36$
 $(36 + 10) \div 16 = 30$
 $\Rightarrow (36 \times 10) \div 12 = 30$
 $\Rightarrow 360 \div 12 = 30$

72. (d)
$$\begin{array}{cccccc} 8 & 3 & 7 & 1 & 0 & 6 \\ \downarrow & \downarrow & \downarrow & \downarrow & \downarrow & \downarrow \\ 4 & 5 & 2 & 7 & 6 & 9 \\ 7 & 0 & 8 & 7 & 7 & \\ \downarrow & \downarrow & \downarrow & \text{and} & \downarrow & \downarrow \\ 2 & 6 & 4 & 2 & 2 & \end{array}$$

 Now, $264 \div 22 = 12$

73. (a) $\frac{1}{3}A = \frac{E}{2}$
 $\Rightarrow \frac{A}{3} - \frac{E}{2} = 0$
 $\Rightarrow 2A - 3E = 0 \dots(i)$
 $A + E = 150 \dots(ii)$
 From equations (i) and (ii)
 $E = 60$

74. (b) According to question
 $2x - 2 = 16$
 $\Rightarrow 2x = 16 + 2$
 $\therefore x = 9$ years

75. (d) $N \Rightarrow 57, 66, 78, 89, 95$
 $A \Rightarrow 58, 69, 75, 87, 96$
 $I \Rightarrow 04, 10, 23, 32, 41$
 $L \Rightarrow 03, 12, 21, 34, 40$

Option	N	A	I	L
(a)	57	87	04	43
(b)	59	58	10	12
(c)	89	57	04	41
(d)	95	87	32	21

76. (c) The numbers 1, 2, 4 and 6 are on adjacent faces of the number 5. Therefore the number 3 lies opposite to 5.

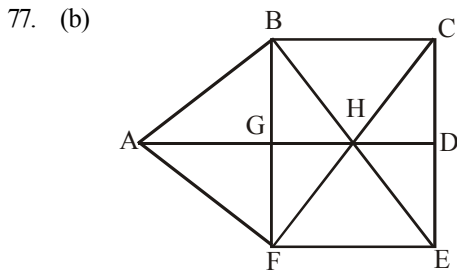

The triangles are:
 $\triangle ABF : \triangle AGB : \triangle AGF : \triangle ABFC;$

$\triangle BCE : \triangle CEF : \triangle BFE : \triangle HBC;$
 $\triangle HCE : \triangle HEF : \triangle HBF : \triangle BGH;$
 $\triangle FGH : \triangle HCD : \triangle HDE : \triangle AFH;$
 $\triangle ABH;$

78. (d)
 79. (b)
 80. (b) The outer arc moves 90° clockwise at each stage, the middle arc moves 90° counter-clockwise, and the inner arc moves 180° .
 81. (b) 82. (d) 83. (d) 84. (a)
 85. (d) 86. (d) 87. (b) 88. (c)
 89. (c) 90. (d) 91. (c) 92. (a)
 93. (b) 94. (d) 95. (a) 96. (b)
 97. (b) 98. (c) 99. (d) 100. (b)
 101. (a) 102. (b) 103. (c) 104. (b)
 105. (c) The situation when a firm is operating at loss in the short period in perfect competition arises when the price is so low that total revenue is not even enough to cover the variable cost of production. Shut down point is that point at which the price is equal to average variable costs or the firm covers its variable costs. So it should operate as long as it covers even the variable costs.
 106. (c) The Planning Commission does not derive its creation from either the Constitution or statute. but is an arm of the Central/Union Government. It was created in 1950 by Government of India by an executive resolution.
 107. (b) 108. (a)
 109. (b) Iltutmish received continuation of his robe of honour and title Nasir amir al-muminin (Helper of the Commander of the Faithful) from the 'Abbasid Caliph al-Mustansir in 626 (1229) and remained on the throne for twenty-six years, This added an element of strength to Iltutmish's authority and gave him a status in the Muslim world .
 110. (a) 111. (d) 112. (d)
 113. (b) Konkan Railway
 114. (d) Surekha Yadav
 115. (b) Swarna Shatabdi
 116. (b) 1 Crore
 117. (a) Gollapalli village
 118. (a) Post-truth
 119. (d) BBC
 120. (a) Uttar pradesh

ARITHMETIC

- 125% of 560 + 22% of 450 = ?
(a) 799 (b) 700
(c) 782 (d) 749
- $4900 \div 28 \times 444 \div 12 = ?$
(a) 6575 (b) 6475
(c) 6455 (d) 6745
- What is the compound interest accrued on an amount of Rs 8500 in two years @ interest 10% per annum?
(a) ₹ 1875 (b) ₹ 1885
(c) ₹ 1775 (d) ₹ 1785
- A train running at the speed of 60 kmph crosses a 200 m long platform in 27 s. What is the length of the train ?
(a) 250m (b) 200m
(c) 240m (d) 450m
- 10 men can complete a piece of work in 8 days. In how many days can 16 men complete that work?
(a) 4 days (b) 5 days
(c) 6 days (d) 3 days
- If the numerator of a certain fraction is increased by 100% and the denominator is increased by 200%; the new fraction thus formed is $\frac{4}{21}$. What is the original fraction?
(a) $\frac{2}{7}$ (b) $\frac{3}{7}$ (c) $\frac{2}{5}$ (d) $\frac{4}{7}$
- The ratio of the ages of A and B seven years ago was 3 : 4 respectively. The ratio of their ages nine years from now will be 7 : 8 respectively. What is B's age at present?
(a) 16 years (b) 19 years
(c) 28 years (d) 23 years
- The perimeter of a square is thrice the perimeter of a rectangle. If the perimeter of the square is 84 cm and the length of the rectangle is 8 cm, what is the difference between the breadth of the rectangle and the side of the square?
(a) 15 cm (b) 19 cm
(c) 10 cm (d) 8 cm
- The area of a circle is equal to the area of a rectangle with perimeter equal to 42 m and breadth equal to 8.5 m. What is the area of the circle?
(a) 116.25 sq m (b) 104.25 sq m
(c) 146.25 sq m (d) 106.25 sq m
- The product of 5% of a positive number and 3% of the same number is 504.6. What is half of that number?
(a) 290 (b) 340
(c) 680 (d) 580
- 4 women and 12 children together take four days to complete a piece of work. How many days will four children alone take to complete the piece of work if two women alone can complete the piece of work in 16 days?
(a) 32 (b) 24
(c) 16 (d) 12
- Anu walks 2.31 km in three weeks by walking an equal distance each day. How many metres does she walk each day?
(a) 110m (b) 90m
(c) 140m (d) 120m
- A man riding a bicycle completes one lap of a square field along its perimeter at the speed of 43.2 km/hr in 1 minute 20 seconds. What is the area of the field?
(a) 52900 sq m (b) 57600 sq m
(c) 48400 sq m (d) Can't be determined
- On Teacher's Day, 4800 sweets were to be equally distributed among a certain number of children. But on that particular day 100 children were absent. Hence, each child got four sweets extra. How many children were originally supposed to be there?
(a) 300 (b) 400
(c) 540 (d) 500
- The ratio of the monthly incomes of Sneha, Tina and Akriti is 95:110:116. If Sneha's annual income is ₹3,42,000, what is Akriti's annual income?
(a) ₹3,96,900 (b) ₹5,63,500
(c) ₹4,17,600 (d) ₹3,88,000

16. A truck covers a distance of 256 km at the speed of 32 km/hr. What is the average speed of a car which travels a distance of 160 km more than the truck in the same time?
 (a) 46 kmh^{-1} (b) 52 kmh^{-1}
 (c) 49 kmh^{-1} (d) 64 kmh^{-1}
17. In an examination, the maximum aggregate marks is 1020. In order to pass the exam a student is required to obtain 663 marks out of the aggregate marks. Shreya obtained 612 marks. By what per cent did Shreya fail the exam?
 (a) 5% (b) 8%
 (c) 7% (d) Can't be determined
-
- DIRECTIONS (Qs. 18-19):** What should come in place of question mark (?) in the following number series?
18. 7 8 4 13 -3 22 ?
 (a) -7 (b) -10
 (c) -12 (d) -14
19. 250000 62500 12500 3125 625 ? 31.25
 (a) 156.25 (b) 172.25
 (c) 125 (d) 150
20. The average age of a lady and her daughter is 28.5. The ratio of their ages is 14 : 5 respectively. What is the daughters age?
 (a) 12 years (b) 15 years
 (c) 18 years (d) Cannot be determined
21. The cost of the paint is ₹ 36.50 per kg. If 1 kg of paint covers 16 square feet, how much will it cost to paint outside of a cube having 8 feet each side?
 (a) ₹ 692 (b) ₹ 768
 (c) ₹ 876 (d) ₹ 972
22. If the polynomial $f(x)$ is such that $f(-43) = 0$, then a factor of $f(x)$ is :
 (a) $x-43$ (b) x
 (c) $x-7$ (d) $x+43$
23. If $(x+1)$ is a factor of $2x^3 - ax^2 - (2a-3)x + 2$, then the value of 'a' is
 (a) 3 (b) 2 (c) $\frac{3}{2}$ (d) $\frac{1}{2}$
24. If $a = \sqrt{2} + 1$, $b = \sqrt{2} - 1$, then the value of $\frac{1}{a+1} + \frac{1}{b+1}$ is
 (a) 9 (b) 3
 (c) 1 (d) 2
25. If $x - \frac{1}{x} = 5$, then find the value of $x^4 + \frac{1}{x^4}$.
 (a) 727 (b) 772
 (c) 722 (d) 277
26. The length of the perpendicular from $(3, -1)$ to the line $12x + 5y + 8 = 0$ is
 (a) $\frac{29}{25}$ unit (b) 5 unit
 (c) 3 unit (d) $\frac{37}{13}$ unit
27. The sum to 200 terms of the series $1 + 4 + 6 + 5 + 11 + 6 + \dots$ is
 (a) 30,400 (b) 29,800
 (c) 30,200 (d) None of these
28. If an equilateral triangle PQR is inscribed in a circle with centre O, then $\angle QOR$ is equal to
 (a) 60° (b) 30°
 (c) 120° (d) 90°
29. Two equal circles pass through each other's centre. If the radius of each circle is 5 cm, what is the length of the common chord?
 (a) $5\sqrt{3}$ (b) $10\sqrt{3}$
 (c) $\frac{5\sqrt{3}}{2}$ (d) 5
30. The product of two number is 2160 and their HCF is 12. Find the possible pairs of numbers.
 (a) 1 (b) 2 (c) 3 (d) 4
31. A man sitting in a train which is travelling at 50 kmph observes that a goods train, travelling in opposite direction, takes 9 seconds to pass him. If the goods train is 280 m long, find its speed.
 (a) 62 kmph (b) 58 kmph
 (c) 52 kmph (d) None of these
32. If $A = \sin^2 \theta + \cos^4 \theta$, then what is the minimum value of A for real values to θ ?
 (a) $\frac{1}{2}$ (b) $\frac{3}{4}$
 (c) 1 (d) 2
33. If $x + \left(\frac{1}{x}\right) = 2 \cos \alpha$, then what is the value of $x^2 + \left(\frac{1}{x^2}\right)$?
 (a) $4 \cos^2 \alpha$ (b) $4 \cos^2 \alpha - 1$
 (c) $2 \cos^2 \alpha - \sin^2 \alpha$ (d) $\cos^2 \alpha - \sin^2 \alpha$

34. The value of $\frac{\sqrt{1+\sin x} + \sqrt{1-\sin x}}{\sqrt{1+\sin x} - \sqrt{1-\sin x}}$ is equal to
 (a) cosec x + cot x
 (b) cosec x + tan x
 (c) sec x + tan x
 (d) cosec x - cot x
35. If $(1 + \tan A)(1 + \tan B) = 2$, then $(A + B)$ is equal to
 (a) $\frac{\pi}{2}$ (b) $\frac{\pi}{3}$
 (c) $\frac{\pi}{4}$ (d) $\frac{\pi}{6}$
36. What is the value of $\sin^3 60^\circ \cot 30^\circ - 2 \sec^2 45^\circ + 3 \cos 60^\circ \tan 45^\circ - \tan^2 60^\circ$?
 (a) $\frac{35}{8}$ (b) $-\frac{35}{8}$
 (c) $-\frac{11}{8}$ (d) $\frac{11}{8}$
37. The angle of elevation of the sun when the length of the shadow of a pole is $\sqrt{3}$ times of its height of the pole is :
 (a) 30° (b) 45°
 (c) 60° (d) 75°

DIRECTIONS (Qs.38-40): Study the following graph to answer the given questions.

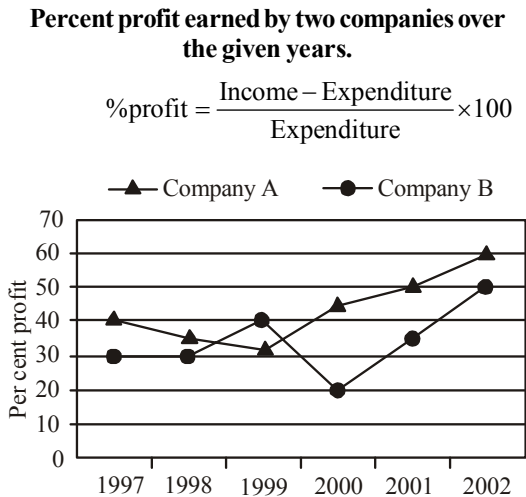

38. If the expenditure of Company B in 2000 was ₹ 200 crores, what was its income?
 (a) ₹ 240 crores
 (b) ₹ 220 crores
 (c) ₹ 160 crores
 (d) Cannot be determined

39. If the income of Company A in 2002 was ₹ 600 crores, what was its expenditure?
 (a) ₹ 360 crores
 (b) ₹ 480 crores
 (c) ₹ 375 crores
 (d) Cannot be determined
40. If the income of Company B in 1998 was ₹ 200 crores, what was its profit in 1999?
 (a) ₹ 21.5 crores (b) ₹ 153 crores
 (c) ₹ 46.15 crores
 (d) Cannot be determined

GENERAL INTELLIGENCE & REASONING

DIRECTIONS (Qs.41-42): In select the related word/ letters/number from the given alternatives :

41. Safe : Secure :: Protect : ?
 (a) Conserve (b) Sure
 (c) Guard (d) Lock
42. Aeroplane : Cockpit :: Train : ?
 (a) Wagon (b) Coach
 (c) Compartment (d) Engine

DIRECTIONS (Qs. 43-44): In each of the following questions, four words have been given, out of which three are alike in some manner and the fourth one is different. Choose out the odd one.

43. (a) Necklace (b) Ornament
 (c) Bangle (d) Ring
44. (a) Correction (b) Improvement
 (c) Betterment (d) Elevation
45. Which one set of letters when sequentially placed at the gaps in the given letter series shall complete it?
 xy_kx_zk_yzk xyz__
 (a) zyxx (b) zyxxz
 (c) zkxyk (d) zyxk
46. In the following question, number of letters are skipped in between by a particular rule. Which of the following series observes the rule?
 (a) BAFHTU (b) ACEGJL
 (c) ACFJOU (d) ADFHJL
47. Find the missing number (?).

3	4	5
2	3	4
1	2	3
14	29	?

- (a) 50 (b) 30 (c) 40 (d) 32

DIRECTIONS (Qs. 48) : *In the following question from among the given alternatives select the one in which the set of numbers is most like the set of numbers given in the questions.*

48. Given Set: (4, 25, 81)
 (a) (4, 36, 79) (b) (9, 48, 81)
 (c) (16, 64, 100) (d) (9, 49, 143)

DIRECTIONS (Qs. 49) : *In each of the following questions, four words have been given, out of which three are alike in some manner and the fourth one is different. Choose out the odd one.*

49. G 4 T, J 10 R, M 20 P, P 43 N, S 90 L
 (a) S 90 L (b) J 10 R
 (c) M 20 P (d) P 43 N

DIRECTION (Qs. 50) : *In each of the following questions various terms of a series are given with one term missing as shown by (?). Choose the missing term.*

50. P 3 C, R 5 F, T 8 I, V 12 L, ?
 (a) Y 17 O (b) X 17 M
 (c) X 17 O (d) X 16 O
51. EXCURTION is coded as CXEURTNOI, SCIENTIST will be coded in the same manner as :
 (a) TSIICSNTE (b) ICSNTETSI
 (c) ICSTNETSI (d) ICSNTEIST
52. If in a certain code, RAMAYANA is written as PYKYWYLY, then how MAHABHARATA can be written in that code?
 (a) NBIBCIBSBUB
 (b) LZGZAGZQZSZ
 (c) MCJCDJCTCVC
 (d) KYFYZFYRY
53. In a joint family there are father, mother, 3 married sons and one unmarried daughter. Of the sons, 2 have 2 daughters each, and one has a son. How many female members are there in the family?
 (a) 2 (b) 3
 (c) 6 (d) 9
54. (I) F is the brother of A,
 (II) C is the daughter of A,
 (III) K is the sister of F,
 (IV) G is the brother of C.
 Who is the uncle of G?
 (a) A (b) C
 (c) K (d) F

55. Mamatha walks 14 metres towards west, then turns to her right and walks 14 metres and then turns to her left and walks 10 metres. Again turning to her left she walks 14 metres. What is the shortest distance (in metres) between her starting point and her present position?
 (a) 38m (b) 28m
 (c) 24m (d) 10m
56. A man starts from a point, walks 2 km towards north, turns towards his right and walks 2 km, turns right again and walks. What is the direction now he is facing?
 (a) South (b) East
 (c) North (d) West
57. Of the five members of a panel sitting in a row. A is to the left of B, but on the right of C, D is on the right of B but is on the left of E. Find the member who is sitting in the middle.
 (a) B (b) D
 (c) A (d) A
58. A, B, C, D and E are sitting on a bench. A is sitting next to B. C is sitting next to D. D is not sitting with E who is on the left end of the bench. C is on the second position from the right. A is on the right of B and E. A and C are sitting together. In which position is A sitting?
 (a) Between B and D (b) Between B and C
 (c) Between E and D (d) Between C and E
59. From the given alternative words, select the word which **cannot** be formed using the letters of the given word:
 'COMPREHENSION'
 (a) COMPRISE (b) PENSION
 (c) ONION (d) PREACH
60. From the given alternative words, select the word which **cannot** be formed using the letters of the given word:
 MISFORTUNE
 (a) FORT (b) TURN
 (c) SOFT (d) ROAM
61. Which one of the given responses would be a meaningful order of the following?
 1. Ocean 2. Rivulet
 3. Sea 4. Glacier
 5. River
 (a) 5, 2, 3, 1, 4 (b) 4, 2, 5, 3, 1
 (c) 5, 2, 3, 4, 1 (d) 4, 2, 1, 3, 5
62. Arrange the following words as per order in the dictionary.
 1. Preposition 2. Preparatively
 3. Preposterous 4. Preponderate
 5. Prepossess
 (a) 2, 4, 1, 5, 3 (b) 1, 5, 2, 4, 3
 (c) 5, 4, 2, 3, 1 (d) 4, 2, 5, 1, 3

63. A national leader was born on 29th February in a particular year. He will have his birthday once in
 (a) 2 years (b) 3 years
 (c) 4 years (d) None of these
64. If two days before yesterday is Monday, what will be the day of the week 3 days after day after tomorrow?
 (a) Thursday (b) Friday
 (c) Wednesday (d) Saturday
65. If the day after tomorrow is Sunday, what day was tomorrow's day before yesterday?
 (a) Friday (b) Thursday
 (c) Monday (d) Tuesday
66. Raju and Nirmala celebrated their first wedding anniversary on Sunday, the 5th of December 1993. What would be the day of their wedding anniversary in 1997?
 (a) Wednesday (b) Thursday
 (c) Friday (d) Tuesday
67. Which diagram correctly represents the relationship between politicians, poets and women?

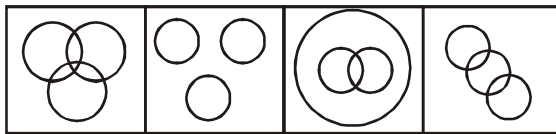

- (a) (b) (c) (d)
68. There are 80 families in a small extension area. 20 percent of these families own a car each. 50 percent of the remaining families own a motor cycle each. How many families in that extension do not own any vehicle?
 (a) 30 (b) 32
 (c) 23 (d) 36

DIRECTIONS (Qs. 69-70): In each of the following question, one, two or more statements are given followed by conclusion I, II or more. You have to consider the statements to be true, even if they seem to be at variance from commonly known facts. You are to decide which of the given conclusions definitely follows from the given statements.

69. Statements:

1. All children are students.
2. All students are players.

Conclusions:

- I. All cricketer are students
- II. All children are players.

- (a) Only conclusion I follows.
- (b) Only conclusion II follows.
- (c) Both conclusions I or II follows.
- (d) Neither conclusion I nor conclusion II follows.

70. Statements:

1. No teacher comes to the school on a bicycle.
2. Anand comes to the school on a bicycle.

Conclusions:

- I. Anand is not a teacher.
 - II. Anand is a student.
- (a) Conclusion I alone can be drawn.
 - (b) Conclusion II alone can be drawn.
 - (c) Both Conclusions can be drawn.
 - (d) Both Conclusions can not be drawn.

71. Select correct combination (sequence) of mathematical signs to replace * signs to balance the equation: $9 * 4 * 22 * 14$

- (a) $\times = -$ (b) $\times - =$
- (c) $= - \times$ (d) $- \times =$

72. If '-' stands for division '+' stands for subtraction, '÷' stands for multiplication, '×' stands for addition, then which one of the following equations is correct?

- (a) $70 - 2 + 4 \div 5 \times 6 = 44$
- (b) $70 - 2 + 4 \div 5 \times 6 = 21$
- (c) $70 - 2 + 4 \div 5 \times 6 = 341$
- (d) $70 - 2 + 4 \div 5 \times 6 = 36$

73. B is twice as old as A but twice younger than F. C is half the age of A but is twice older than D. Who is the second oldest?

- (a) B (b) F
- (c) D (d) C

74. A two member committee comprising of one male and one female member is to be constituted out of five males and three females. Amongst the females, Ms. A refuses to be a member of the committee in which Mr. B is taken as the member. In how many different ways can the committee be constituted?

- (a) 11 (b) 12
- (c) 13 (d) 14

DIRECTIONS (Qs. 75): This section contains multiple choice questions. Each question has 4 choices (a), (b), (c) and (d) out of which ONLY ONE is correct.

75. 'F' can be represented by 14, 21, etc., and 'E' can be represented by 20, 32, etc. Identify the set for the word FIRE.

MATRIX - I

	0	1	2	3	4
0	D	E	F	I	N
1	I	N	D	E	F
2	E	F	I	N	D
3	N	D	E	F	I
4	F	I	N	D	E

MATRIX - II

	5	6	7	8	9
5	O	P	R	S	T
6	S	T	O	P	R
7	P	R	S	T	O
8	T	O	P	R	S
9	R	S	T	O	P

- (a) 21, 22, 88, 33 (b) 14, 10, 69, 14
 (c) 33, 34, 76, 22 (d) 02, 03, 57, 01

76. On the basis of two positions of dice, find what number will be on the opposite face of number 5 ?

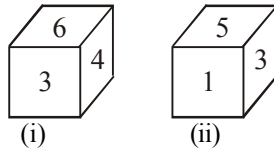

- (a) 1 (b) 3
 (c) 4 (d) 5

77. How many triangles are there in the following figure?

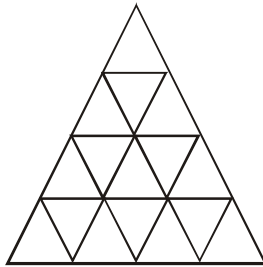

- (a) 29 (b) 27
 (c) 23 (d) 30

78. Among the four answer figures, which figure can be formed from the cut-pieces given below in the question figure?

Question Figure:

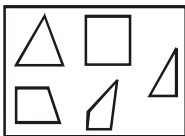

Answer Figure:

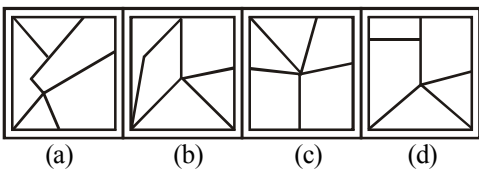

DIRECTION (Q.79) : In each of the following questions a set of three figures 1, 2 and 3 showing a sequence of folding of a piece of paper. Fig. (3) shows the manner in which the folded paper has been cut. These three figures are followed by four answer figures from which you have to choose a figure which would most closely resemble the unfolded form of fig. (3).

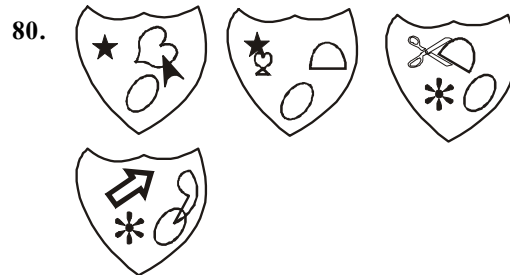
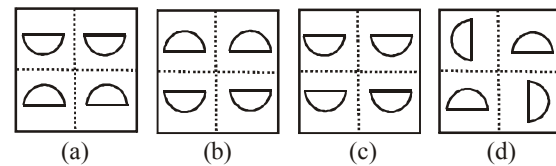
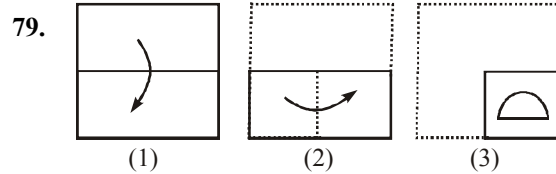

What comes next in the above sequence ?

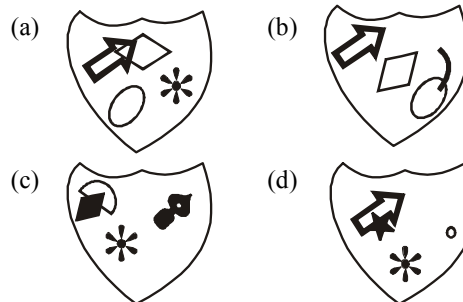

GENERAL AWARENESS

81. Several computers linked to a server to share programs and storage space
- (a) Network (b) grouping
 (c) library (d) integrated system
82. A prescribed set of well-defined instructions for solving mathematical problems is called
- (a) a compiler (b) a code
 (c) a description (d) an algorithm

83. The process of preparing a floppy diskette for use is called
- (a) assembling (b) translating
(c) parsing (d) formatting
84. LAN stands for
- (a) Local Access Network
(b) Local Area Network
(c) Logical access network
(d) Logical Area Network
85. A Field is a related group of
- (a) Records (b) Files
(c) Characters (d) Cables
86. Which one of the following is not a line of demarcation between two countries?
- (a) International Date Line
(b) MacMahon Line
(c) Radcliffe Line
(d) Durand Line
87. Which of the following dances belongs originally to Kerala ?
- (a) Odissi (b) Kathak
(c) Kuchipudi (d) Kathkali
88. Nathu-La is located in Himalayas. What does 'La' mean ?
- (a) Glacier (b) Pass
(c) Hillock (d) Crevasse
89. Selectivity of a receiver can be increased by -
- (a) Using more tuned circuit
(b) Decreasing number of tuned circuits
(c) Using loud speaker
(d) Increasing gain of the receiver
90. What will happen if a transformer is connected to D.C. voltage?
- (a) It will induce more voltage
(b) Its reactance will increase
(c) The primary will burn out and no emf will be induced in the secondary
(d) None of these
91. The unit of noise pollution (level) is -
- (a) decibel (b) decimal
(c) ppm (d) None of these
92. Transition ions absorb light in -
- (a) visible region (b) infrared region
(c) ultraviolet region (d) microwave region
93. According to kinetic theory gases, at the temperature absolute zero, the gas molecules -
- (a) Start movement
(b) Become massless
(c) Start emitting light
(d) Stop movement
94. Tides are primarily a result of the -
- (a) Attraction of the moon
(b) Farrel's Law
(c) Ocean currents
(d) Pressure system of the earth
95. Electric fuse wire is made of alloys because alloys -
- (a) Have low melting point
(b) Have high melting point
(c) Are economical
(d) Do not get heated easily
96. Which two colours can be mixed to make green?
- (a) Yellow and Black (b) Yellow and Blue
(c) Orange and Violet (d) Purple and Yellow
97. The freezing point of fresh water is -
- (a) 0°C (b) 4°C
(c) 3°C (d) 5°C
98. Flywheel is an important part of a steam engine because it -
- (a) gives strength to the engine
(b) accelerates the speed of the engine
(c) helps the engine in keeping the speed uniform
(d) decreases the moment of inertia
99. To provide opportunities for education to the child or as the case may be, ward between the age of six and fourteen years is a :
- (a) Fundamental Right under Indian Constitution
(b) Fundamental Duty under Indian Constitution
(c) Directive Principles of State Policy Under Indian Constitution
(d) Legal Right under Indian Constitution
100. Find the incorrect statement with respect to duration of houses of Parliament:
- (a) The council of states shall not be subject to dissolution
(b) As nearly as possible 1/3 of members of council of states shall retire as soon as may be on the expiration of every second year
(c) While the proclamation of emergency is operation for maximum period allowed under the constitution of India and has ceased to operate, the period of House of the people may be extended for a period of one year and not beyond
(d) The House of the people, unless sooner dissolved, shall continue for five years from the date appointed for its first meeting

101. Who shall be the ex-officio Chairman of Council of States?
 (a) The President of India
 (b) The Vice President of India
 (c) The Council of states shall choose a member the council to act as chairman
 (d) The Speaker of the House of People
102. Which of the following systems in independent India goes against the very basis of democracy?
 (a) Caste system
 (b) Economic system
 (c) Party system
 (d) Parliamentary system
103. The blank space between stamps in a sheet is known as
 (a) Traffic Light (b) Vignette
 (c) Margin (d) Gutter
104. Who was the author of "Athihyamala" ?
 (a) Sanjayan
 (b) Kottarathil Sankunni
 (c) Poonthanam
 (d) None of these
105. Supreme Court Judge is appointed by the ___?
 (a) Prime Minister (b) President
 (c) Parliament (d) Chief Justice
106. United Nations Day is observed on
 (a) October 21 (b) October 22
 (c) October 23 (d) October 24
107. World Post Day is observed on
 (a) November 9 (b) November 14
 (c) October 9 (d) October 24
108. "A thing of beauty is a joy for ever" is a line written by?
 (a) John Keats
 (b) Percy Bysshe Shelley
 (c) Alexander Pope
 (d) Alfred Tennyson
109. Study of Fossils is known as?
 (a) Paleontology (b) Petrology
 (c) Seismology (d) None of the above
110. A citizen can directly move the Supreme Court for any violation of Fundamental Rights under
 (a) Article 31 (b) Article 32
 (c) Article 33 (d) Article 34
111. Which one of the following sitting Vice-Presidents of India contested for the post of President and lost the election?
 (a) S. Radhakrishnan
 (b) V.V.Giri
 (c) Bhairon Singh Shekhawat
 (d) Both (B) and (C)
112. The French challenge to British in India came to an end with
 (a) Battle of Wandiwash
 (b) Battle of Srirangapattinam
 (c) Battle of Plassey
 (d) Battle of Buxar
113. Which country has the highest railway line in the world?
 (a) Tanggula (b) Australia
 (c) India (d) Japan
114. The world's longest railway platform is in India. In which state is it?
 (a) Madhya Pradesh
 (b) Uttar Pradesh
 (c) West Bengal
 (d) Punjab
115. Which is the only country to have a fully electrified railway network?
 (a) Japan (b) China
 (c) India (d) Switzerland
116. Name the scheme launched to provide free electricity connection to each household in the Bihar in the next two years.
 (a) Har Ghar Bijli Lagataar
 (b) Har Ghar Ujala Yojna
 (c) Ghar Ghar Roshini ka Vada
 (d) Deen Dayal Upadhyaya Gram Jyoti Yojana
117. What is the revamped Toll-free helpline number launched by UIDAI to help residents get quick access to information about Aadhaar.
 (a) 1007 (b) 1991
 (c) 1866 (d) 1947
118. Which country will host T20 Cricket World Cup for the Blind in 2017?
 (a) Australia (b) India
 (c) Pakistan (d) New Zealand
119. The government will reintroduce compulsory class X board examination for ___ schools from 2017.
 (a) ICSE (b) CBSE
 (c) CISCE (d) State Board(SB)
120. Recently which state has become the first state to adopt 'Fly Ash Utilisation Policy'?
 (a) Karanataka (b) Maharasthra
 (c) Madhya Pradesh (d) Chhatisgarh

Hints & Explanations

1. (a) $? = 125\% \text{ of } 560 + 22\% \text{ of } 450$

$$\Rightarrow ? = \frac{125}{100} \times 560 + \frac{22}{100} \times 450$$

$$\Rightarrow ? = \frac{70000}{100} + \frac{9900}{100}$$

$$\Rightarrow ? = 700 + 99 = 799$$

2. (b) $? = 4900 \div 28 \times 444 \div 12$

$$\Rightarrow ? = 175 \times 37$$

$$\Rightarrow ? = 6475$$

3. (d) Compound Interest after two years

$$= 8500 \left(1 + \frac{10}{100} \right)^2 - 8500$$

$$= 8500 \times \frac{11}{10} \times \frac{11}{10} - 8500$$

$$= 10285 - 8500 = ₹ 1785$$

4. (a) Let length of the train be x m
Speed of the train be 60 km/h

$$= 60 \times \frac{5}{18} = \frac{50}{3} \text{ m/s}$$

$$\text{Then, } \frac{x+200}{\frac{50}{3}} = 27$$

$$\Rightarrow \frac{3(x+200)}{50} = 27$$

$$\Rightarrow 3x + 600 = 1350$$

$$\Rightarrow 3x = 1350 - 600$$

$$\Rightarrow 3x = 750$$

$$\Rightarrow x = \frac{750}{3} = 250 \text{ m}$$

5. (b) Suppose 16 men can complete the same work in x days

Then, Men days

$$\begin{array}{cc} 10 \uparrow & 8 \downarrow \\ 16 \downarrow & x \uparrow \end{array}$$

$$16 : 10 :: 8 : x$$

$$\Rightarrow 16 \times x = 10 \times 8$$

$$\Rightarrow x = \frac{10 \times 8}{16} = 5 \text{ days}$$

6. (a) Let the original fraction be $= \frac{x}{y}$.

$$\therefore \frac{x \times 200}{y \times 300} = \frac{4}{21} \Rightarrow \frac{x}{y} = \frac{4}{21} \times \frac{3}{2} = \frac{2}{7}$$

7. (d) Let the present age of A = x and B = y years
According to first condition

$$\frac{x-7}{y-7} = \frac{3}{4} \Rightarrow 4x - 28 = 3y - 21 \Rightarrow 4x - 3y = 7 \dots (i)$$

According to second condition

$$\frac{x+9}{y+9} = \frac{7}{8} \Rightarrow 8x + 72 = 7y + 63$$

$$\Rightarrow 7y - 8x = 9 \dots (ii)$$

$$8x - 6y = 14$$

$$\frac{7y - 8x = 9}{y = 23 \text{ years.}}$$

8. (a) Perimeter of the square = 84 cm
Perimeter of the rectangle = 28 cm
Perimeter of the rectangle = $2(1 + b)$
or, $2(8 + b) = 28$ cm
or, $b = 14 - 8 = 6$ cm.
 \therefore Breadth of the rectangle = 6 cm

$$\text{Side of the square} = \frac{84}{4} = 21 \text{ cm}$$

$$\text{Difference} = 21 - 6 = 15 \text{ cm.}$$

9. (d) Perimeter of the rectangle = 42 m

$$2(l + b) = 42 \text{ m}$$

$$\text{or, } l + 8.5 = 21 \text{ m}$$

$$\text{or, } l = 12.5 \text{ m.}$$

$$\text{Area of the rectangle} = 12.5 \times 8.5 = 106.25 \text{ sq.m.}$$

$$\therefore \text{Area of the circle} = 106.25 \text{ sq.m.}$$

10. (d) Let the positive number be x .
- Then, $\frac{5x}{100} \times \frac{3x}{100} = 504.6$
- $\therefore x \times \frac{5}{100} \times x \times \frac{3}{100} = 504.6$
- or, $x^2 = \frac{504.6 \times 100 \times 100}{15}$
- $\therefore x = 580$.
11. (b) Two women alone can complete a piece of work in 16 days.
- \therefore Four women can complete the same work in 8 days.
- Since 12 children can complete the work in $\frac{4 \times 8}{8-4} = \frac{4 \times 8}{4} = 8$ days.
- \therefore Four children can complete the work in $\frac{12 \times 8}{4} = 24$ days.
12. (a) $2.31 \text{ km} = 2.31 \times 1000 = 2310 \text{ m}$
- Total number of days = $3 \times 7 = 21$
- \therefore Distance covered by Anu each day = $\frac{2310}{21} = 110 \text{ m}$.
13. (b) $43.2 \text{ m/hr} = 43.2 \times \frac{5}{18} = 12 \text{ m/s}$
- Total distance covered = $12 \times 80 = 960 \text{ m}$.
- Perimeter of the square = 960 m .
- Side of the square = 240 m .
- Area = $(240)^2 = 57600 \text{ sqm}$.
14. (b) Let the number of children be x .
- Now, according to the question
- $$\left(\frac{4800}{x} - 100\right)(x+4) = 4800$$
- or, $\left(\frac{48}{x} - 1\right)(x+4) = 48$
- or, $(48-x)(x+4) = 48x$
- or, $x^2 + 4x - 192 = 0$
- or, $(x+16)(x-12) = 0$
- $\therefore x = 12$ sweets
- Number of students = $\frac{4800}{12} = 400$.
15. (c) Sneha's monthly income
- $$= \frac{342000}{12} = 28500$$
- \therefore Akruiti's monthly income
- $$= \frac{28500}{95} \times 116 = 34800$$
- Akruiti's annual income = 417600 .
16. (b) Time taken by the truck = $\frac{256}{32} = 8 \text{ hr}$.
- Distance covered by the car = $(256 + 160) = 416 \text{ km}$.
- Time = 8 hr .
- \therefore Speed of the car = $\frac{416}{8} = 52 \text{ km/hr}$.
17. (a) Required percentage
- $$= \frac{663 - 612}{1020} \times 100 = 5\%$$
18. (d)
- | | | | | | | |
|---|---|----|----|----|----|-----|
| | | +5 | | -9 | | |
| 7 | 8 | 4 | 13 | -3 | 22 | -14 |
| | | -3 | | -7 | | -11 |
19. (a) $250000 \div 4 = 62500$
- $62500 \div 5 = 12500$
- $12500 \div 4 = 3125$
- $3125 \div 5 = 625$
- $625 \div 4 = \boxed{156.25}$
- $156.25 \div 5 = 31.25$.
20. (b) Average age = 28.5
- \therefore Total age = $28.5 \times 2 = 57$
- \therefore Daughter's age = $\frac{5}{19} \times 57 = 15$ years
21. (c) Surface area of the cube = $(6 \times 8^2) \text{ sq. ft.}$
- = 384 sq. ft.
- Quantity of paint required
- $$= \left(\frac{384}{16}\right) \text{ kg} = 24 \text{ kg.}$$
- \therefore Cost of painting = ₹ $(36.50 \times 24) = ₹ 876$.
22. (d) If $f(-43) = 0$, then by factor theorem, we get $(x+43)$ is a factor of the polynomial $f(x)$.
23. (a) Let $f(x) = 2x^3 - ax^2 - (2a-3)x + 2$
- If $(x+1)$ is a factor of the above expression, then $f(-1) = 0$

We have,

$$\begin{aligned} f(-1) &= 2(-1)^3 - a(-1)^2 - (2a-3) \times (-1) + 2 = 0 \\ \Rightarrow -2 - a + 2a - 3 + 2 &= 0 \Rightarrow a - 3 \Rightarrow a \\ &= 3 \end{aligned}$$

24. (c) $a = \sqrt{2} + 1 \Rightarrow a + 1 = \sqrt{2} + 2$

$$\begin{aligned} \Rightarrow \frac{1}{a+1} &= \frac{1}{2+\sqrt{2}} \\ &= \frac{2-\sqrt{2}}{(2+\sqrt{2})(2-\sqrt{2})} = \frac{2-\sqrt{2}}{4-2} = \frac{2-\sqrt{2}}{2} \end{aligned}$$

$$b+1 = \sqrt{2} \Rightarrow \frac{1}{b+1} = \frac{\sqrt{2}}{2}$$

$$\therefore \frac{1}{a+1} + \frac{1}{b+1} = \frac{2-\sqrt{2}}{2} + \frac{\sqrt{2}}{2} = \frac{2}{2} = 1$$

25. (a) $\therefore \left(x - \frac{1}{x}\right) = 5$

Squaring both sides,

$$\left(x - \frac{1}{x}\right)^2 = (5)^2$$

$$\Rightarrow x^2 + \frac{1}{x^2} - 2 \times x \times \frac{1}{x} = 25$$

$$\Rightarrow x^2 + \frac{1}{x^2} = 25 + 2 = 27$$

Squaring both sides again

$$\left(x^2 + \frac{1}{x^2}\right)^2 = (27)^2$$

$$\Rightarrow x^4 + \frac{1}{x^4} + 2 \times x^2 \times \frac{1}{x^2} = 729$$

$$\Rightarrow x^4 + \frac{1}{x^4} + 2 = 729 \Rightarrow x^4 + \frac{1}{x^4} = 729 - 2$$

$$\Rightarrow x^4 + \frac{1}{x^4} = 727$$

26. (c) Length of the perpendicular

$$= \frac{12 \times 3 + 5(-1) + 8}{\sqrt{12^2 + 5^2}} = 3 \text{ unit}$$

27. (c) Above series is a combination of two APs.

The 1st AP is $(1 + 6 + 11 + \dots)$ and the 2nd AP is $(4 + 5 + 6 + \dots)$

Since the terms of the two series alternate,
 $S = (1 + 6 + 11 + \dots \text{to } 100 \text{ terms}) + (4 + 5 + 6 + \dots \text{to } 100 \text{ terms})$

$$= \frac{100[2 \times 1 + 99 \times 5]}{2} + \frac{100[2 \times 4 + 99 \times 1]}{2}$$

(Using the formula for the sum of an AP)
 $= 50[497 + 107] = 50[604] = 30200$

Alternatively, we can treat two consecutive terms as one.

So we will have a total of 100 terms of the nature :

$(1+4) + (6+5) + (11+6) \dots \Rightarrow 5, 11, 17, \dots$

Now, $a = 5$, $d = 6$ and $n = 100$

Hence the sum of the given series is

$$S = \frac{100}{2} \times [2 \times 5 + 99 \times 6] = 50[604] = 30200$$

28. (c) As PQR is an equilateral triangle inscribed in a circle,

$$\angle QPR = 60^\circ,$$

$$\therefore \angle QOR = 2 \times \angle QPR = 2 \times 60^\circ = 120^\circ$$

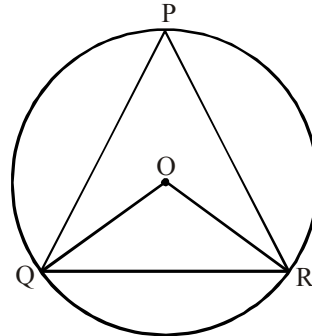

29. (a)

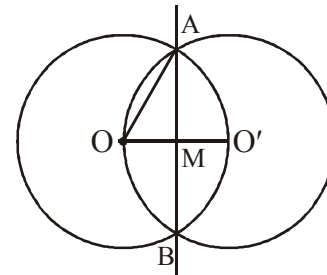

Given, distance between the centres of two circle = 5 cm

$$OO' = 5 \text{ cm}$$

$$\therefore OM = \frac{5}{2} \text{ cm}$$

$$\begin{aligned} \text{In } \triangle OAM, \\ OA^2 = OM^2 + AM^2 \end{aligned}$$

$$(5)^2 = \left(\frac{5}{2}\right)^2 + AM^2$$

$$AM = \sqrt{25 - \frac{25}{4}} = \frac{5\sqrt{3}}{2} \text{ cm}$$

\therefore The length of common chord, $AB = 2 \times AM$

$$= 2 \times \frac{5\sqrt{3}}{2} = 5\sqrt{3} \text{ cm}$$

30. (b) HCF = 12. Then let the numbrs be $12x$ and $12y$.

$$\text{Now } 12x \times 12y = 2160 \quad \therefore \quad xy = 15$$

Possible values of x and y are $(1, 15)$; $(3, 5)$; $(5, 3)$; $(15, 1)$

\therefore the possible pairs of numbers $(12, 180)$ and $(36, 60)$

31. (a) Relative speed

$$= \left(\frac{280}{9}\right) \text{ m/sec} = \left(\frac{280}{9} \times \frac{18}{5}\right) \text{ kmph}$$

$$= 112 \text{ kmph.}$$

\therefore Speed of goods train = $(112 - 50) \text{ kmph} = 62 \text{ kmph.}$

32. (b) $\sin^2 \theta + \cos^4 \theta = A$ or $1 - \cos^2 \theta + \cos^4 \theta = A$

$$\Rightarrow \cos^4 \theta - \cos^2 \theta + (1 - A) = 0$$

For real value of θ , $b^2 - 4ac \geq 0 \Rightarrow 1 - 4(1 - A) \geq 0$

$$\Rightarrow 4A - 3 \geq 0 \Rightarrow A \geq \frac{3}{4}$$

33. (b) $\cos^2 0^\circ + \cos^2 3^\circ + \cos^2 6^\circ + \cos^2 9^\circ + \dots$

$$\dots + \cos^2 42^\circ + \cos^2 45^\circ + \cos^2 48^\circ +$$

$$\dots + \cos^2 81^\circ + \cos^2 84^\circ + \cos^2 87^\circ +$$

$$\cos^2 90^\circ$$

$$= 1 + (\cos^2 3^\circ + \cos^2 87^\circ) + (\cos^2 6^\circ + \cos^2 84^\circ) + (\cos^2 9^\circ + \cos^2 81^\circ) + \dots + \cos^2 45^\circ$$

$$= 1 + (1) + \dots + \frac{1}{2}$$

$$= 15 + \frac{1}{2} = 15.5$$

34. (a) $\frac{\sqrt{1+\sin x} + \sqrt{1-\sin x}}{\sqrt{1+\sin x} - \sqrt{1-\sin x}} = \frac{(\sqrt{1+\sin x} + \sqrt{1-\sin x})^2}{(1+\sin x) - (1-\sin x)}$

$$= \frac{2 + 2\sqrt{1-\sin^2 x}}{2\sin x} = \frac{1 + \cos x}{\sin x}$$

$$= \operatorname{cosec} x + \cot x$$

35. (c) $1 + \tan A + \tan B + \tan A \tan B = 2$

$$\Rightarrow \tan A + \tan B + \tan A \tan B = 1$$

$$\Rightarrow \tan A + \tan B = 1 - \tan A \tan B$$

$$\Rightarrow \frac{\tan A + \tan B}{1 - \tan A \tan B} = 1 = \tan 45^\circ$$

$$\Rightarrow \tan (A + B) = \tan 45^\circ \Rightarrow A + B = \frac{\pi}{4}$$

36. (b) $\sin^3 60^\circ \cot 30^\circ - 2 \sec^2 45^\circ$

$$+ 3 \cos 60^\circ \tan 45^\circ - \tan^2 60^\circ$$

$$= \left(\frac{\sqrt{3}}{2}\right)^3 \cdot \sqrt{3} - 2 \cdot (\sqrt{3})^2 + 3 \cdot \frac{1}{2} \cdot 1 - (\sqrt{3})^2$$

$$= \frac{3\sqrt{3}}{8} \times \sqrt{3} - 2 \times 2 + \frac{3}{2} - 3 = \frac{9}{8} - 4 + \frac{3}{2} - 3$$

$$= \frac{9 - 32 + 12 - 24}{8} = \frac{21 - 56}{8} = -\frac{35}{8}$$

37. (a) Let AB be a pole of height h and BC be its shadow. Therefore, $BC = \sqrt{3}h$

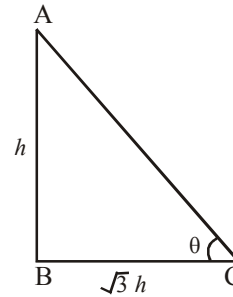

$$\text{Here, } \tan \theta = \frac{h}{\sqrt{3}h}, \text{ or } \tan \theta = \frac{1}{\sqrt{3}}$$

$$\text{or } \theta = \tan^{-1} \frac{1}{\sqrt{3}} = 30^\circ$$

38. (a) Income of Company B in 2000

$$= 200 \times \frac{120}{100} = ₹ 240 \text{ crores}$$

39. (c) Expenditure of Company A in 2002

$$= 600 \times \frac{100}{160} = ₹ 375 \text{ crores}$$

40. (d) We can find out the amount of profit in 1998, we do not know the income and expenditure of A and B. therefore, option d is the correct choice.
41. (c) The words in each pair are synonyms of each other.
42. (d) As the pilot of an aeroplane sits in the cockpit, the driver of a train works in the engine.
43. (b): All others are different types of ornaments.
44. (d): All others are synonyms.

45. (a) XY Z K/X Y ZK / X YZK / XYZ K / X

46. (c)

B $\xrightarrow{-1}$ A $\xrightarrow{+5}$ F $\xrightarrow{+2}$ H $\xrightarrow{+12}$ T $\xrightarrow{+1}$ U

A $\xrightarrow{+2}$ C $\xrightarrow{+2}$ E $\xrightarrow{+2}$ G $\xrightarrow{+3}$ J $\xrightarrow{+2}$ L

A $\xrightarrow{+2}$ C $\xrightarrow{+3}$ F $\xrightarrow{+4}$ J $\xrightarrow{+5}$ O $\xrightarrow{+6}$ U

A $\xrightarrow{+3}$ D $\xrightarrow{+2}$ F $\xrightarrow{+2}$ H $\xrightarrow{+2}$ J $\xrightarrow{+2}$ L

47. (a) $(3)^2 + (2)^2 + (1)^2$
 $= 9 + 4 + 1 = 14$
 $(4)^2 + (3)^2 + (2)^2$
 $= 16 + 9 + 4 = 29$

Similarly,
 $(5)^2 + (4)^2 + (3)^2 = 25 + 16 + 9 = 50$

48. (c) The numbers given in the set are perfect Squares.
 $4 = (2)^2$; $25 = (5)^2$.
 $81 = (9)^2$
 Similarly
 $16 = (4)^2$; $64 = (8)^2$
 $100 = (10)^2$.

49. (b) The letters of the alphabet on the first positions move + 3 steps forward while the numerical components in the middle move with the following pattern.
 $\times 2 + 1, \times 2 + 2, \times 2 + 3, \times 2 + 4 \dots\dots$
 Therefore, J10R does not fit in the series.

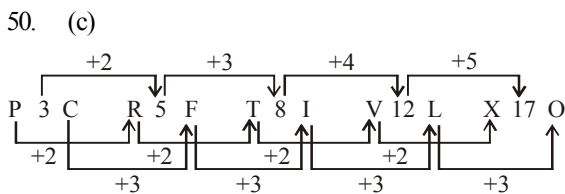

51. (c) The word is divided into three equal sections, and the letters of first and third sections are written backwards.

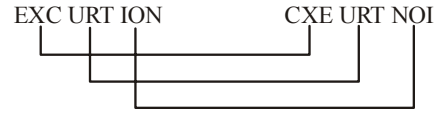

Similarly,

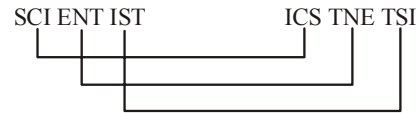

52. (d)
53. (d) Female members: Mother, 3 daughter-in-law, one daughter, Four grand daughters. Thus, there are nine female members.
54. (d) G is the son of A and F is brother of A.

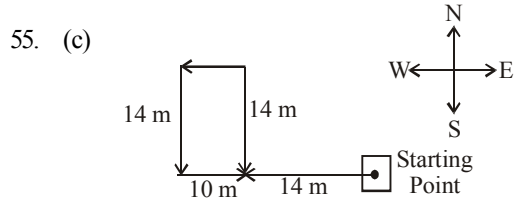

Required distance = $10 + 14 = 24$ metres

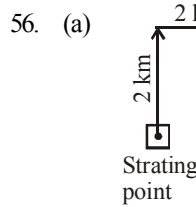

It is clear from the diagram that he is facing towards south.

57. (a) LEFT C A B D E RIGHT

↓
Middle

58. (b) Sitting arrangement

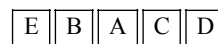

59. (d) There is no 'A' letter in the keyword.
60. (d) There is no 'A' letter in the keyword.

61. (b) Meaningful order of the given words :

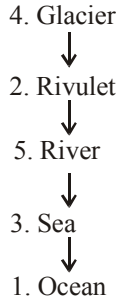

62. (a) 2. Preparatively

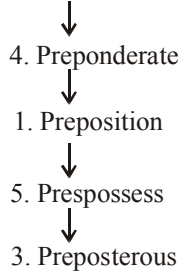

63. (c) 29th February comes in a Leap Year. Therefore, his birthday will come once in four years.

64. (a) Two days before yesterday was Monday. Therefore, today is Monday + 4 = Friday. Tomorrow will be Saturday after Tomorrow will be Sunday. Now, three days after Sunday will be Thursday.

65. (b) The day after tomorrow is Sunday. Therefore, today is Friday. The day on tomorrow's day before yesterday = Friday - 1 = Thursday

66. (c) Total number of days = $27 + 365 + 365 + 365 + 339 = 1461$ days
Now, $1461 \div 7 = 5$ Odd days
Therefore, 5th December, 1997 would be Sunday + 5 = Friday

67. (d) Some politicians may be poets and vice-versa.
Some politicians may be women and vice-versa.
No poet can be women as women poet is called poetess.

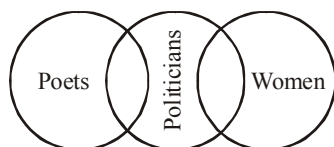

68. (b) $20\% \text{ of } 80 = \frac{20}{100} \times 80 = 16$

50% of remaining

$= (80 - 16) \times \frac{50}{100} = 32$

The families which do not own any vehicle.
 $= 80 - (32 + 16)$
 $= 80 - 48 = 32$

69. (b) Both the Premises are Universal Affirmative (A-type).

All children are students.

All students are players.

$A + A \Rightarrow A$ -type of Conclusion.

“All children are players.”

This is Conclusion II.

70. (a) It is clear that Anand is not a teacher. Anand may be student or clerical staff.

71. (b) $9 \times 4 - 22 = 14$
 $\Rightarrow 36 - 22 = 14$

72. (b) $70 \div 2 - 4 \times 5 + 6 = 44$
 $\Rightarrow 35 - 20 + 6 = 44$

$\Rightarrow 15 + 6 \neq 44$
 $70 \div 2 - 4 \times 5 + 6 = 21$

$\Rightarrow 35 - 20 + 6 = 21$
 $\Rightarrow 41 - 20 = 21$

73. (a) $B = 2A$
 $F = 2B$
 $A = 2C$
 $C = 2D$

$F > B > A > C > D$

74. (d) Total number of ways in which the committee can be formed
 $= 5 \times 3 = 15$

But Ms A refuses to be a member of the committee in which Mr. B is taken as a member.

Therefore, the required answer.

$15 - 1 = 14$

75. (d) $F \Rightarrow 02, 14, 21, 33, 40$
 $I \Rightarrow 03, 10, 22, 34, 41$
 $R \Rightarrow 57, 69, 76, 88, 95$
 $E \Rightarrow 01, 13, 20, 32, 44$

Option	F	I	R	E
(a)	21	22	88	33
(b)	14	10	69	44
(c)	33	34	76	22
(d)	02	03	57	01

76. (c) Common number i.e. 3 to both the dice is placed on the central position of the figure. Now place the numbers in the anticlockwise direction in block I, II, III and IV respectively. Remaining number i.e. 2 will come in the block V. Hence number 4 is opposite to number 5.

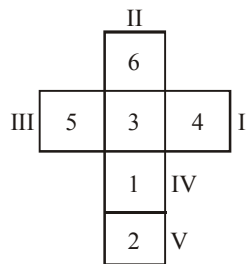

77. (b)

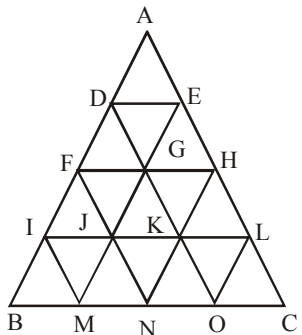

The triangles are:
 $\triangle ABC$; $\triangle ADE$; $\triangle AFH$; $\triangle AIL$;
 $\triangle DFG$; $\triangle DIK$; $\triangle DBO$; $\triangle GDE$;

$\triangle EGH$; $\triangle EJL$; $\triangle EMC$; $\triangle FIJ$;
 $\triangle FBN$; $\triangle JFG$; $\triangle GJK$; $\triangle KGH$;
 $\triangle HKL$; $\triangle HNC$; $\triangle NFH$; $\triangle GMO$;
 $\triangle IBM$; $\triangle MIJ$; $\triangle JMN$; $\triangle NJK$;
 $\triangle KNO$; $\triangle OKL$; $\triangle LOC$;

78. (c) 79. (a)
 80. (d) When two figures touch, they disappear at the next stage and are replaced by two different figures.
 81. (a) 82. (d) 83. (d) 84. (b) 85. (a)
 86. (a) The International Date Line (IDL) is an imaginary line on the surface of the Earth from the north to the south pole and demarcates one calendar day from the next. It passes through the middle of the Pacific Ocean, roughly following the 180° longitude but it deviates to pass around some territories and island groups.
 87. (d) 88. (b) 89. (b) 90. (c) 91. (a)
 92. (a) 93. (d) 94. (a) 95. (a) 96. (b)
 97. (a) 98. (c) 99. (a) 100. (c) 101. (b)
 102. (a) 103. (c) 104. (d) 105. (b) 106. (d)
 107. (c) 108. (a) 109. (a)
 110. (b) A citizen has the right to 'move the supreme court' (under article 32) directly in case s/ he faces any violation of his/her fundamental rights.
 111. (c) Bhairon Singh Shekhawat was the 11th Vice-President of India. He served in that position from August 2002, when he was elected to a five-year term, until he resigned on July 21, 2007, after losing the presidential election to Pratibha Patil.
 112. (a) 113. (a) 114. (c) 115. (d) 116. (a)
 117. (d) 118. (b) 119. (b) 120. (b)

ARITHMETIC

- Ram went to a shop to buy 50 kg of rice. He bought two varieties of rice which cost him ₹ 4.50 per kg and ₹ 5 per kg. He spent a total of ₹ 240. What was the quantity of the cheaper rice purchased by him ?
(a) 20 Kg (b) 25 Kg
(c) 30 Kg (d) 40 kg
- A man has ₹ 640 in the denominations of one rupee, five rupee and ten rupee notes. The number of each type of notes are equal. What is the total number of notes he has ?
(a) 60 (b) 150
(c) 90 (d) 120
- Which of the following fractions are in ascending order ?
(a) $\frac{2}{3}, \frac{3}{5}, \frac{7}{9}, \frac{9}{11}, \frac{8}{9}$
(b) $\frac{3}{5}, \frac{2}{3}, \frac{9}{11}, \frac{7}{9}, \frac{8}{9}$
(c) $\frac{3}{5}, \frac{2}{3}, \frac{7}{9}, \frac{9}{11}, \frac{8}{9}$
(d) $\frac{8}{9}, \frac{9}{11}, \frac{7}{9}, \frac{2}{3}, \frac{3}{5}$
- If $\frac{4}{5}$ th of an estate is worth ₹ 16,800, then the value of $\frac{3}{7}$ th of the estate is
(a) ₹ 9000 (b) ₹ 21000
(c) ₹ 72000 (d) ₹ 90000
- Simplify: $\frac{69 \times 69 \times 69 - 65 \times 65 \times 65}{69 \times 69 + 69 \times 65 + 65 \times 65}$
(a) 1 (b) 4
(c) 0.216 (d) 0.164
- How many digits will be there to the right of the decimal point in the product of 95.75 and 0.02554 ?
(a) 5 (b) 6
(c) 7 (d) Insufficient data
- If the sum of a few numbers is 450 and their mean is 50 and if another number 100 is included, the mean would become
(a) 55 (b) 60
(c) 75 (d) 150
- In a mixture of 60 litres, the ratio of milk and water is 2 : 1. What amount of water must be added to make the ratio of milk and water as 1 : 2 ?
(a) 42 Litres (b) 56 Litres
(c) 60 Litres (d) 77 Litres
- 19 persons went to a hotel for a combined dinner party. 13 of them spent ₹ 79 each on their dinner and the rest spent ₹ 4 more than the average expenditure of all the 19. What was the total money spent by them ?
(a) 1878 (b) 1760
(c) 1536 (d) 1492
- The average weight of 5 men is increased by 2 Kg when one of the men whose weight is 60 Kg is replaced by a new man. The weight of the new man is
(a) 50 Kg (b) 65 Kg
(c) 68 Kg (d) 70 Kg
- In an examination a candidate has to get 35% of total marks to pass. In one paper he gets 62 out of 150 and in the second 35 out of 150. How many marks should he get out of 200 marks in the third paper to pass ?
(a) 61 (b) 68
(c) 70 (d) 78
- A mixture of 40 litres of milk and water contains 10% water. How much water should be added to this mixture so that the new mixture contains 20% water ?
(a) 4 litres (b) 5 litres
(c) 6.5 litres (d) 7.5 litres
- Two-third of a consignment was sold at a profit of 5% and the remainder at a loss of 2% if the total profit was ₹ 400, what was the value of the consignment ?
(a) ₹ 13,000/- (b) ₹ 17,000/-
(c) ₹ 15,000/- (d) ₹ 40,000/-
- The sum of the number of boys and girls in a school is 150. If the number of boys is x, then the number of girls becomes x% of the total number of students. How many boys are there in the school?
(a) 51 (b) 65
(c) 60 (d) 95

15. A sell 2 TV sets, one at a loss of 15% and another at a profit of 15%. Find the loss/gain percentage in the overall transaction?
- (a) 2.25% (b) 3%
(c) 4% (d) No profit, no loss

Directions (Qs. 16-17): What will come in place of question mark (?) in the following questions?

16. 32.05% of 259.99 = ?
(a) 92 (b) 88
(c) 78 (d) 83
17. $\frac{1}{8}$ of $\frac{2}{3}$ of $\frac{3}{5}$ of 1715 ?
(a) 80 (b) 85
(c) 90 (d) 95

Directions (Qs. 18-19): In each of these questions, a number series is given. In each series, only one number is wrong. Find out the wrong number.

18. 32 16 24 65 210 945 5197.5
(a) 945 (b) 16
(c) 24 (d) 65
19. 7 13 25 49 97 194 385
(a) 13 (b) 49
(c) 97 (d) 194
20. Present age of Sudha and Neeta are in the ratio of 6 : 7 respectively. Five years ago their ages were in the ratio of 5 : 6 respectively. What is Sudha's present age?
(a) 30 years (b) 35 years
(c) 40 years
(d) Cannot be determined
21. The capacity of a cylindrical tank is 246.4 litres. If the height is 4 metres, what is the diameter of the base?
(a) 1.4m (b) 2.8m
(c) 14m (d) None of these
22. If $\sqrt{x} - \sqrt{49} = 8.2$, then the value of x is equal to:
(a) 1.20 (b) 1.40
(c) 1.44 (d) 1.89
23. When $x^5 + 1$ is divided by $(x-2)$, the remainder is:
(a) 15 (b) 17
(c) 31 (d) 33
24. If $a = 3 + 2\sqrt{2}$, then the value of $\frac{a^6 - a^4 - a^2 - 1}{a^3}$ is
(a) 192 (b) 240
(c) 204 (d) 212

25. If $x - \frac{1}{x} = 4$ find the value of $x^3 - \frac{1}{x^3}$

- (a) 75 (b) 76
(c) 67 (d) 57
26. The length of perpendicular from (4, 3) to the straight line which makes intercepts 4, 3 on the axes, is
(a) $\frac{7}{5}$ (b) $\frac{9}{5}$
(c) $\frac{12}{5}$ (d) $\frac{24}{5}$
27. If the sum of the series $54 + 51 + 48 + \dots$ is 513, then the number of terms are
(a) 18 (b) 20
(c) 17 (d) None of these
28. An arc of 60° in one circle is double the arc in a second circle whose radius is three times that of the first circle. What is the degree measure of the arc of the second circle?
(a) 30° (b) 20°
(c) 10° (d) 1°
29. In a circle of radius 10 cm, a chord is drawn 6 cm from its centre. If another chord, half the length of the original chord were drawn, its distance in centimetres from the centre would be :
(a) $\sqrt{84}$ (b) 9
(c) 8 (d) 3π
30. The traffic lights at three different road crossings change after every 48 sec., 72 sec., and 108 sec. respectively. If they all change simultaneously at 8:20:00 hrs, then at what time will they again change simultaneously?
(a) 10 (b) 12
(c) 14 (d) 16
31. Two trains are running at 40 km/h and 20 km/h respectively in the same direction. Fast train completely passes a man sitting in the slower train in 5 seconds. What is the length of the fast train?
(a) 23m (b) $23\frac{2}{9}$ m
(c) 27m (d) $27\frac{7}{9}$ m
32. The maximum value of $(\sin \theta + \cos \theta)$ is
(a) 1 (b) $\sqrt{2}$
(c) 2 (d) $2\sqrt{2}$

33. If $7 \sin^2 x + 3 \cos^2 x = 4$, $0 < x < 90^\circ$, then the value of $\tan x$ is
 (a) $\sqrt{3}$ (b) 1
 (c) $\frac{\sqrt{3}}{2}$ (d) $\frac{1}{\sqrt{3}}$
34. If $\tan A + \sin A = p$, $\tan A - \sin A = q$, then
 (a) $p^2 + q^2 = 4\sqrt{pq}$ (b) $p^2 - q^2 = 4\sqrt{pq}$
 (c) $p^2 - q^2 = \sqrt{pq}$ (d) $p^2 - q^2 = 2\sqrt{pq}$
35. If $x = \cot \theta + \operatorname{cosec} \theta$, what is the value of $\frac{1 + \cos \theta}{1 - \cos \theta}$?
 (a) x (b) x^2
 (c) $\frac{1}{x}$ (d) $\frac{1}{x^2}$
36. If $\tan 62^\circ = \frac{P}{Q}$, then $\tan 28^\circ$ is equal to
 (a) $\frac{P}{Q}$ (b) $\frac{Q}{P}$
 (c) $\frac{P^2 - Q^2}{P}$ (d) $\frac{Q}{P^2}$
37. The angles of elevation of an artificial satellite measured from two earth stations are 30° and 60° , respectively. If the distance between the earth stations is 4000 km, then the height of the satellite is :
 (a) 2000 km (b) 6000 km
 (c) 3464 km (d) 2828 km

Directions (Qs. 38-40): Study the following graph carefully and answer the questions given below:

The following graph shows the percentage growth of Branded and Assembled PCs

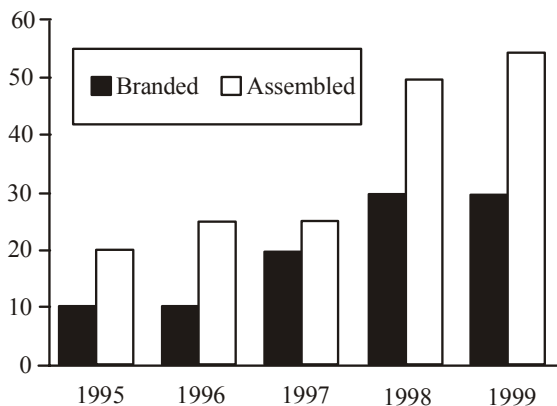

38. What is the average percentage growth of sales of Assembled PCs for the given years?
 (a) 30 (b) 20
 (c) 40 (d) 35
39. If the Branded PCs sold in 1996 were 100000, how many Branded PCs were sold in 1999?
 (a) 202800 (b) 156000
 (c) 234000 (d) 300000
40. What is the difference between total Branded and total Assembled PCs sold for the given years?
 (a) 75000 (b) 750000
 (c) 175000 (d) Cannot be determined

GENERAL INTELLIGENCE & REASONING

Directions (41-42): Select the related word/letters/number from the given alternatives.

41. Book : Publisher :: Film : ?
 (a) Producer (b) Director
 (c) Editor (d) Writer
42. Radio : Listener :: Film : ?
 (a) Producer (b) Actor
 (c) Viewer (d) Director

Directions (43-44): In each of the following questions, four words have been given, out of which three are alike in some manner and the fourth one is different. Choose out the odd one.

43. (a) Sailor (b) Tailor
 (c) Goldsmith (d) Blacksmith
44. (a) Broker (b) Salesman
 (c) Customer (d) Hawker
45. Which one set of letters when sequentially placed at the gaps in the given letter series shall complete it?
 ac _ cab _ baca _ aba _ aca _
 (a) acbcc (b) aacbc
 (c) babbb (d) bcbba

Directions (Q. 46): In the following question, a series is given, with one/two term(s) missing. Choose the correct alternative from the given ones that will complete the series.



46. ? DREQ, GUHT, JXKW
 (a) EFRS (b) TGSE
 (c) JWVI (d) AOBN

47. Find the wrong number in the series. 6, 12, 21, 32, 45, 60
 (a) 6 (b) 12
 (c) 21 (d) 32

Direction (Qs. 48-50): In each of the following questions various terms of a series are given with one term missing as shown by (?). Choose the missing term.

48. 56, 90, 132, 184, 248, ?
 (a) 368 (b) 316
 (c) 362 (d) 326
49. C4X, F9U, I16R, ?
 (a) L25P (b) L25O
 (c) L27P (d) None of these
50. 2Z5, 7Y7, 14X9, 23W11, 34V13, (?)
 (a) 27U24 (b) 45U15
 (c) 47U15 (d) 47V14
51. If MEKLF is coded as 91782 and LLLJK as 88867, then how can IGHED be coded?
 (a) 97854 (b) 64521
 (c) 53410 (d) 75632
52. If in a certain code HYDROGEN is written as JCJZYSSD, then how can ANTIMONY be written in that code?
 (a) CPVKOQPA (b) CRZQWABO
 (c) ERXMQSRC (d) GTZOSUTE
53. What is the relation between the son of Rajkumar's sister's father in law and Raj Kumar.
 (a) Father, Son
 (b) Father-in-law, Son-in-law
 (c) Son-in-law, Father-in-law
 (d) Uncle, Nephew
54. A is father of C and D is son of B. E is brother of A. If C is sister of D how is B related to E?
 (a) Sister-in-law (b) Sister
 (c) Brother (d) Brother-in-law
55. Sandhya walks straight from point A to B which is 2 kms away. She turns left, at 90° and walks 8 kms to C, where she turns left again at 90° and walks 5 kms to D. At D she turns left at 90° and walks for 8 kms to E. How far is she from A to E?
 (a) 2 (b) 3
 (c) 5 (d) 8
56. A man starts from a point, walks 4 miles towards north and turns left and walks 6 miles, turns right and walks for 3 miles and again turns right and walks 4 miles and takes rest for 30 minutes. He gets up and walks straight 2 miles in the same direction and turns right and walks on mile. What is the direction he is facing?

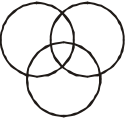
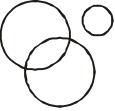
- (a) North (b) South
 (c) South-east (d) West
57. Among five children A, B, C, D and E. B is taller than E but shorter than A. A is shorter than C but taller than D who is taller than B. If all the children stand in a line according to their heights, who would be fourth if counted from the tallest one?
 (a) A (b) E
 (c) D (d) B
58. P, Q, R and T answered an Examination. In the result Q was immediately followed by 'P'. 'R' was ahead of 'Q' but could not score as much as 'T'. Who scored the second highest?
 (a) P (b) Q
 (c) R (d) T
59. From the given alternative words, select the word which can be formed using the letters of the given word:
 STRANGULATION
 (a) TRIANGLE (b) GARLAND
 (c) ROASTING (d) TRAUMA
60. From the given alternative words, select the word which **cannot** be formed using the letters of the given word:
 CONCENTRATION
 (a) CONCERN (b) NATION
 (c) TRAIN (d) CENTRE
61. Which one of the given responses would be a meaningful order of the following?
 1. Sentence 2. Word
 3. Chapter 4. Phrase
 5. Paragraph
 (a) 4, 3, 1, 2, 5 (b) 2, 3, 5, 4, 1
 (c) 3, 5, 1, 4, 2 (d) 1, 3, 2, 4, 5
62. Arrange the following words as per order in the dictionary:
 1. Inhabit 2. Ingenious
 3. Inherit 4. Influence
 5. Infatuation
 (a) 1, 2, 3, 4, 5 (b) 5, 4, 1, 2, 3
 (c) 4, 5, 2, 1, 3 (d) 5, 4, 2, 1, 3
63. If 3rd January is Sunday, what date will be three days after the fourth Wednesday in the month?
 (a) 30 (b) 27
 (c) 26 (d) 23
64. Mohit correctly remembers that his father's birthday is not after eighteenth of April. His sister correctly remembers that their father's birthday is before twentieth but after seventeenth of April. On which day in April was definitely their father's birthday?

- (a) Seventeenth
(b) Nineteenth
(c) Eighteenth
(d) Seventeenth or Eighteenth
65. Mrs. Susheela celebrated her wedding anniversary on Tuesday, 30th September 1997. When will she celebrate her next wedding anniversary on the same day?
(a) 30 September 2003
(b) 30 September 2004
(c) 30 September 2002
(d) 30 October 2003
66. A clock gains five minutes every hour. What will be the angle traversed by the second hand in one minute?
(a) 360° (b) 360.5°
(c) 390° (d) 380°
67. Which one of the following diagrams represent the correct relationship among 'Judge', 'Thief' and 'Criminal'?
- (a)  (b) 
- (c)  (d) 
68. Out of 100 families in the neighbourhood, 50 have radios, 75 have TVs and 25 have VCRs. Only 10 families have all three and each VCR owner also has a TV. If some families have radio only, how many have only TV?
(a) 30 (b) 35
(c) 40 (d) 45

Direction (Qs. 69-70): In each of the following questions, one, two or more statements are given followed by conclusion I, II or more. you have to consider the statements to be true, even if they seem to be at variance from commonly known facts. You are to decide which of the given conclusions definitely follows from the given statements.

69. **Statements:**

- Some food are sweet.
- Some food are sour.

Conclusions:

- All food are either sweet or sour.
- Some sweets are sour.

- (a) Only Conclusion I follows.
(b) Only conclusion II follows.
(c) Both Conclusions I and II follows.
(d) Neither conclusion I nor II follows.

70. **Statements:**

- Science teachers do not use plastic bags.
- Plastic bags are not use by some engineers.

Conclusions:

- All Science teachers are engineers.
 - All Engineers do not use plastic bags.
- (a) Only conclusion I follows.
(b) Only conclusion II follows.
(c) Both conclusions I and II follow.
(d) Neither conclusion I nor II follows.

71. Some equations are solved on the basis of a certain system. Find the correct answer for the unsolved equation on that basis. If $324 \times 289 = 35$, $441 \times 484 = 43$, $625 \times 400 = 45$, find the value of 256×729 .

- (a) 33 (b) 35
(c) 43 (d) 34

72. If \div stands for division, \times for multiplication, $+$ for subtraction and \times for addition, then which one of the following equations is correct?

- (a) $19 + 5 - 4 \times 2 \div 4 = 11$
(b) $19 \times 5 - 4 \div 2 + 4 = 16$
(c) $19 \div 5 + 4 - 2 \times 4 = 13$
(d) $19 \div 5 + 4 + 2 \div 4 = 20$

73. Shan is 55 years old, Sathian is 5 years junior to Shan and 6 years senior of Balan. The youngest brother of Balan is Devan and he is 7 years junior to him. So what is the age difference between Devan and Shan?

- (a) 18 years (b) 15 years
(c) 13 years (d) 7 years

74. Ravi has spent a quarter $\left(\frac{1}{4}\right)$ of his life as a

boy, one-fifth $\left(\frac{1}{5}\right)$ as a youth, one-third $\left(\frac{1}{3}\right)$ as man and thirteen (13) years in old age. What is his present age?

- (a) 70 years (b) 80 years
(c) 60 years (d) 65 years

75. 'F' can be represented by 02, 14, 33, etc. and 'K' can be represented by 56, 68, 87 etc. Identify the set for the word BUSH.

MATRIX - I

	0	1	2	3	4
0	M	L	F	H	B
1	H	B	M	L	F
2	L	F	H	B	M
3	B	M	L	F	H
4	F	H	B	M	L

MATRIX - II

	5	6	7	8	9
5	L	K	S	U	N
6	U	N	I	K	S
7	K	S	U	N	I
8	N	I	K	S	U
9	S	U	N	I	K

- (a) 22, 77, 57, 23 (b) 23, 77, 57, 22
 (c) 23, 77, 56, 22 (d) 23, 77, 57, 21

76. Three views from the same cube are given. All the faces of the cube are numbered from 1 to 6. Select one figure which will result when the cube is unfolded.

Question Figures:

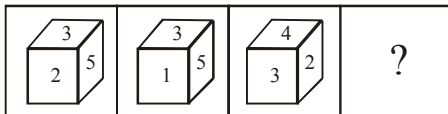

Answer Figure:

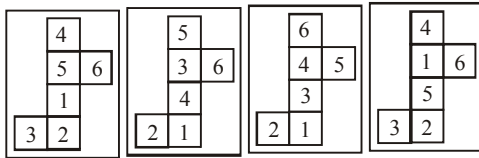

- (a) (b) (c) (d)

77. How many triangles are there in the given figure?

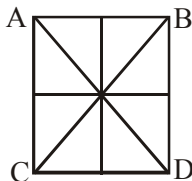

- (a) 16 (b) 14
 (c) 8 (d) 12

78. Which answer figure will complete the pattern in the question figure?

Question Figure:

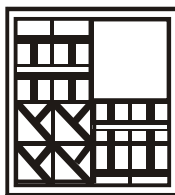

Answer Figure:

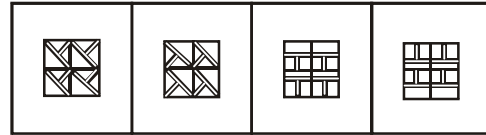

- (a) (b) (c) (d)

DIRECTION (Q.79) : In each of the following questions a set of three figures 1, 2 and 3 showing a sequence of folding of a piece of paper. Fig. (3) shows the manner in which the folded paper has been cut. These three figures are followed by four answer figures from which you have to choose a figure which would most closely resemble the unfolded form of fig. (3).

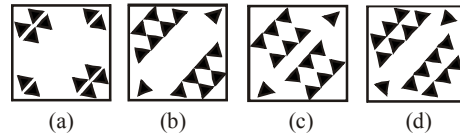
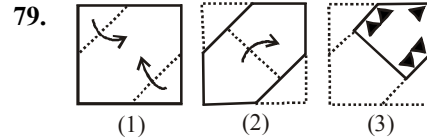

- (a) (b) (c) (d)

DIRECTIONS (Q. 80) : In each of the following questions there are given five figures. If two of these figures are interchanged in a question, the five figures are arranged in a certain order. You have to select from the four given alternatives the correct answer for each question.

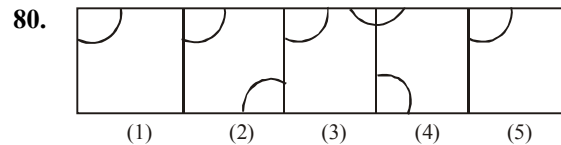

- (a) 1,2 (b) 1,3
 (c) 2,3 (d) 2,4

GENERAL AWARENESS

81. Meaningful filename helps in easy file
 (a) Storing (b) Accessing
 (c) Identification (d) Printing
82. To restart the computer key is used.
 (a) Del + Ctrl (b) Backspace + Ctrl
 (c) Ctrl + Alt + Del (d) Reset

83. Housing all hardware, software, storage, and processing in one site location is called
- time-sharing
 - a distributed system
 - centralized processing
 - A host computer
84. A computer works on a number system.
- binary
 - octal
 - decimal
 - hexadecimal
85. A record is related to a file, as a statement is related to a
- procedure
 - file
 - program
 - data
86. What is GARNISHEE order?
- An order issued by the court prohibiting withdrawal from the account of a depositor
 - An executive order prohibiting withdrawal from the account of a depositor
 - A Court order issued prohibiting transaction of a particular land
 - None of these
87. Identify the medical trio of Ancient India from the following names.
- Charaka, Susruta and Vagbhata
 - Charaka, Vatsyayana and Vagbhata
 - Charaka, Susruta and Bharata
 - Charaka, Susruta and Patanjali
88. Highly polluted water could have a Biological Oxygen Demand (BOD) value of:
- 17 ppm or more
 - Less than 5 ppm
 - Less than 4 ppm
 - Less than 3 ppm
89. Uber cup and Thomas cup are associated with:
- Chess
 - Cricket
 - Badminton
 - Table Tennis
90. The headquarter of International Olympic Committee is situated at:
- Lausanne, Switzerland
 - Geneva, Switzerland
 - Zurich, Switzerland
 - None of the above
91. Supersonic plane fly with the speed
- less than the speed of sound
 - of sound
 - greater than the speed of sound
 - of light
92. Mach number is used in connection with the speed of
- sound
 - aircraft
 - spacecraft
 - ships
93. On a stationary sail boat, air is blown from a fan attached to the boat. The boat
- moves in opposite direction in which the air is blown
 - does not move
 - moves in the same direction in which air blows
 - spins around
94. Rainbow is due to
- absorption of sunlight in minute water droplets
 - diffusion of sunlight through water droplets
 - ionisation of water deposits
 - refraction and reflection of sunlight by water droplets
95. Stars which appear single to the naked eye but are double when seen through a telescope are
- novas & supernovas
 - binaries
 - asteroids
 - quasars
96. ML^2T^{-2} is the dimensional formula for
- moment of inertia
 - pressure
 - elasticity
 - couple acting on a body
97. Radio telescopes are better than optical telescopes because
- they can detect faint galaxies which no optical telescope can
 - they can work even in cloudy conditions
 - they can work during the day and night
 - All of the above
98. Light Emitting Diodes (LED) is used in fancy electronic devices such as toys emit
- X-rays
 - ultraviolet light
 - visible light
 - radio waves
99. Out of the following pairs, which one does not have identical dimension?
- Moment of inertia and moment of a force
 - Work and Torque
 - Angular momentum and Planck's constant
 - Impulse and Momentum
100. Mercury is commonly used as a thermometric fluid rather than water because
- specific heat of mercury is less than water
 - specific heat of mercury is more than water
 - mercury has greater visibility than water
 - density of mercury is more than the water
101. Optical fibre works on the
- principle of refraction
 - total internal reflection
 - Scattering
 - Interference

102. Which of the following is NOT a method of voting in the Lok Sabha?
 (a) Voice vote (b) Division
 (c) Casting vote (d) Tactial vote
103. Three of India's mountain peaks are arranged below in the descending order of height. Which is the correct order?
 (a) Kanchenjunga, Nanda Devi, Badrinath peak
 (b) Kanchenjunga, Badrinath peak, Nanda Devi
 (c) Badrinath peak, Kanchenjunga, Nanda Devi
 (d) Badrinath peak, Nanda Devi, Kanchenjunga
104. Which of the following Indian states shares a border with China?
 (a) Haryana (b) Himachal Pradesh
 (c) Mizoram (d) Punjab
105. What is the ratio of the width of India's National Flag to its length?
 (a) Two to three (b) One to two
 (c) Three to four (d) Two to five
106. Which of the following is NOT true of Indian Standard Time?
 (a) 5.5 hours ahead GMT
 (b) 4.5 hours behind Australian Eastern Standard Time
 (c) 10.5 hours ahead of American Eastern Standard Time
 (d) India has two Standard Times.
107. In which part of India is desert region located?
 (a) Eastern and north eastern
 (b) Western and northwestern
 (c) Western and southwestern
 (d) Eastern and southeastern
108. Which of the following is NOT true of water?
 (a) It makes up 70% of earth's surface
 (b) About 97% of water on earth's surface is too salty for drinking or irrigation
 (c) A molecule of water consists of two atoms of hydrogen and one atom of oxygen
 (d) Zero degree Fahrenheit is the temperature at which water freezes.
109. The first woman to conquer Mount Everest twice is
 (a) Surja Lata Devi
 (b) Jyoti Randhawa
 (c) Santosh Yadav (d) Suma Shirur
110. Which one of the following iron and steel works in India is *not* under public sector?
 (a) Bokaro (b) Jamshedpur
 (c) Bhilai (d) Durgapur
111. India's first scented postage stamp has the fragrance of
 (a) Rose (b) Sandalwood
 (c) Jasmine (d) Lemon
112. Which of the following is correct about the postal network of the world?
 (a) India has the largest number of post offices and the largest number or postal employees
 (b) India has the largest number of post offices, but does not employ the largest number of postal employees.
 (c) India employs the largest number of postal employees, but does not have the largest number of post offices.
 (d) There are many countries with more number of post offices than India has.
113. How many years of its existence did the Indian Railways celebrate in the year 2002-2003?
 (a) 50 (b) 150
 (c) 25 (d) 100
114. After Kolkata, which city in India started a metro railway?
 (a) New Delhi (b) Mumbai
 (c) Bengaluru (d) Hyderabad
115. Mumbai has the world's busiest suburban railway network. Name it.
 (a) Western Line (b) Harbour Line
 (c) Central Line (d) Eastern Line
116. Which Indian city will host India-China Joint Training Exercise "Hand-in-Hand 2016"?
 (a) Kochi (b) Pune
 (c) Bhubaneswar (d) Madurai
117. Prime Minister Narendra Modi flagged off a weekly 'Shabd Bhedi' Superfast Express train to run between which cities?
 (a) Ghazipur & Kolkata (b) Jaipur & Kolkata
 (c) Bathinda & Ghazipur (d) Ghazipur & Jaipur
118. The 14-Days India International Trade Fair (IITF) is organized in which state?
 (a) Ahemdabad (b) New Delhi
 (c) Pune (d) Mumbai
119. What is the new date for presenting the union Budget as decided by government of India?
 (a) February 20 (b) March 1
 (c) February 28 (d) February 1
120. Which country is going to host invictus games 2018?
 (a) New Zealand (b) Singapore
 (c). Australia (d) Japan

Hints & Explanations

1. (a) Let one variety of rice be x kg.
Another quantity = $(50 - x)$ kg
According to question $x \times 4.50 + (50 - x) 5 = 240$
 $4.5x + 250 - 5x = 240$
 $0.5x = 10$
 $x = 20$
Hence, the quantity of cheaper rice was 20 kg.
2. (d) Let the number of each type of notes be x .
According to question $1 \times x + 5 \times x + 10 \times x = 640$
 $16x = 640$
 $x = 40$
Total number of notes = $40 + 40 + 40 = 120$
3. (c) $\frac{2}{3}$ 0.67
 $\frac{3}{5}$ 0.6
 $\frac{7}{9}$ 0.7
 $\frac{9}{11}$ 0.81
 $\frac{8}{9}$ 0.88
Correct Ascending order
 $= \frac{3}{5} \frac{2}{3} \frac{7}{9} \frac{9}{11} \frac{8}{9}$
4. (a) Let the value of estate be x .
 $\frac{4}{5}x = 16800 \Rightarrow x = 16800 \times \frac{5}{4} = 21000$
Then, $\frac{3}{7} \times 21000 = 9000$
5. (b) $\frac{69 \times 69 \times 69 - 65 \times 65 \times 65}{69 \times 69 + 69 \times 65 + 65 \times 65}$
Using $\frac{a^3 - b^3}{a^2 + ab + b^2} = a - b$
 $\therefore 69 - 65 = 4$
6. (b) $95.75 \times 0.02554 = 2.445455$
There are 6 digits to the right of the decimal point in the product of 95.75 and 0.02554.
7. (a) $50 \frac{\text{Sum of all numbers}}{\text{number of observations}}$
 $50 \frac{450}{\text{Number of observations}}$
Number of observations = $\frac{450}{50} = 9$
New mean = $\frac{450}{10} - \frac{100}{10} = \frac{550}{10} = 55$
8. (c) Milk = $\frac{2}{3} \times 60 = 40$ l
Water = $\frac{1}{3} \times 60 = 20$ l
Let 'x' be the amount to be added to milk and water.
 $\frac{40}{20} = \frac{x}{x} = \frac{1}{2}$
 $80 + 2x = 20 + x$
 $60 = x$
9. (c) Let average of all persons = x
 $\therefore (13 \times 79) + 6(x + 4) = 19 \times x$
 $13 \times 79 + 6x + 24 = 19x$
 $13 \times 79 + 24 = 13x$
 $x = \frac{13 \times 79 + 24}{13} = 80.25$
Total money spent = 1536
10. (d) Let total weight of 5 men be x kg and weight of new man y kg.
 $\frac{x - 60y}{5} = \frac{y}{5} - 2$
 $\Rightarrow \frac{x}{5} - 12 = \frac{y}{5} - 2$
 $\Rightarrow y = 70$ kg
weight of new man = 70 kg
11. (d) Total marks = $150 + 150 + 200 = 500$
35% of 500 = 175
 $175 = 62 + 35 + x$
 $x = 78$

12. (b) Milk contains in mixture = 36 liters.
Water contains in mixture = 4 liters
Let 'x' be the water added to the mixture.

$$\frac{36}{4} = \frac{x}{20}$$

$$36 = 16 + 4x$$

$$20 = 4x$$

$$\therefore x = 5 \text{ litres}$$

13. (c) Let value of consignment was ₹ x

$$\left(\frac{2}{3}\right)^{\text{rd}} \text{ consignment costs } \frac{2x}{3}$$

$$\text{Selling price of } \left(\frac{2}{3}\right)^{\text{rd}} \text{ consignment}$$

$$= \frac{2x}{3} + \frac{5}{100} \times \frac{2x}{3} = \frac{7}{10}x$$

$$\text{S.P. of } \left(\frac{1}{3}\right)^{\text{rd}} \text{ consignment} =$$

$$\frac{x}{3} - \frac{2}{100} \times \frac{x}{3} = \frac{49}{150}x$$

$$\text{Total S.P.} = \frac{49x}{150} + \frac{7x}{10} = \frac{49x + 105x}{150} = \frac{154x}{150}$$

$$\text{Profit} = \text{S.P.} - \text{C.P.}$$

$$400 = \frac{154x}{150} - x = \frac{4x}{150}$$

$$x = \frac{400 \times 150}{4} = 15000$$

Value of consignment was ₹ 15,000

14. (c) If number of boys is x, then number of girls is (150-x)

$$(150-x) = x \% \text{ of } 150$$

$$150-x = \frac{x}{100} \times 150 = \frac{3x}{2}$$

$$\Rightarrow \frac{5x}{2} = 150$$

$$\Rightarrow x = \frac{150 \times 2}{5} = 60$$

Number of boys is 60

15. (d) Let x be the cost price of T.V.

$$\text{loss} = 15\%$$

$$\text{then, S.P.}_1 = x - 15\% \text{ of } x = 0.85x$$

$$\text{Profit} = 15\%$$

$$\text{then, S.P.}_2 = x + 15\% \text{ of } x = 1.15x$$

$$\text{total S.P.} = 0.85x + 1.15x = 2x$$

$$\text{Profit} = 2x - 2x = 0$$

No profit, no loss

16. (d) $\frac{32}{100} \times 260 = 83.2 \approx 83$

17. (b) $\frac{1}{8} \times \frac{2}{3} \times \frac{3}{5} \times 1715 = 85.75 \approx 85$

18. (d)

$$\begin{array}{ccccccccc} 32 & 16 & 24 & 60 & 210 & 945 & 5197.5 \\ \times 0.5 & \times 1.5 & \times 2.5 & \times 3.5 & \times 4.5 & \times 5.5 \end{array}$$

65 is written in place of 60.

19. (d)

$$\begin{array}{ccccccccc} 7 & 13 & 25 & 49 & 97 & 193 & 385 \\ +6 & +12 & +24 & +48 & +96 & +192 \end{array}$$

194 is written in place of 193

20. (a) Let Sudh's and Neeta's present ages be 6x and 7x years respectively

According to the question.

$$\frac{6x-5}{7x-5} = \frac{5}{6}$$

$$\Rightarrow 36x - 30 = 35x - 25$$

$$\Rightarrow x = 5$$

$$\therefore \text{Sudha's present age} = 6 \times 5 = 30 \text{ years}$$

21. (d) Volume of the tank = 246.4 litres = 246400 cm³.

Let the radius of the base be r cm. Then,

$$\left(\frac{22}{7} \times r^2 \times 400\right) = 246400$$

$$\Rightarrow r^2 = \left(\frac{246400 \times 7}{22 \times 400}\right) = 196 \Rightarrow r = 14$$

$$\therefore \text{Diameter of the base} = 2r = 28 \text{ cm} = .28 \text{ m}$$

22. (c) $\sqrt{x} = 8.2 - 7 = 1.2$

$$\Rightarrow x = (1.2)^2 = 1.44$$

23. (d) Let $f(x) = x^5 + 1$

Since (x-2) is the factor of (x⁵+1), hence from Remainder

$$\text{Theorem, we have, } f(2) = (2)^5 + 1 = 33$$

Hence, the remainder = 33

24. (c) $a = 3 + 2\sqrt{2}$

$$\Rightarrow \frac{1}{a} = \frac{1}{3 + 2\sqrt{2}} = \frac{1}{3 + 2\sqrt{2}} \times \frac{3 - 2\sqrt{2}}{3 - 2\sqrt{2}}$$

$$= \frac{3-2\sqrt{2}}{9-8} = 3-2\sqrt{2}$$

$$\therefore a + \frac{1}{a} = 6$$

$$\text{Now, } \frac{a^6 - a^4 + a^2 - 1}{a^3}$$

$$= \frac{a^6}{a^3} - \frac{a^4}{a^3} + \frac{a^2}{a^3} - \frac{1}{a^3}$$

$$= \left(a^3 - \frac{1}{a^3} \right) \left(a + \frac{1}{a} \right)$$

$$= \left(a + \frac{1}{a} \right)^3 - 3a \times \frac{1}{a} \left(a + \frac{1}{a} \right) \left(a + \frac{1}{a} \right)$$

$$= (6)^3 - 3(6) + 6 = 216 - 18 + 6 = 204$$

25. (b) $\therefore x - \frac{1}{x} = 4$

Cubing both sides,

$$\left(x - \frac{1}{x} \right)^3 = (4)^3$$

$$\Rightarrow x^3 - \frac{1}{x^3} - 3 \times x \times \frac{1}{x} \left(x - \frac{1}{x} \right) = 64$$

$$\Rightarrow x^3 - \frac{1}{x^3} - 3 \left(x - \frac{1}{x} \right) = 64$$

$$\Rightarrow x^3 - \frac{1}{x^3} - 3 \times 4 = 64$$

$$\Rightarrow x^3 - \frac{1}{x^3} = 64 + 12 = 76$$

26. (c) The equation of given line is $\frac{x}{4} - \frac{y}{3} = 1$ or $3x + 4y = 12$.

$$\therefore \text{Length} = \frac{3 \times 4 + 4 \times 3 - 12}{\sqrt{3^2 + 4^2}} = \frac{12}{5}$$

27. (a)

28. (c) $\theta_1 = \frac{l_1}{r_1}$ and $\theta_2 = \frac{l_2}{r_2}$

$$\frac{\theta_1}{\theta_2} = \frac{l_1 \cdot r_2}{l_2 \cdot r_1} = \frac{2l_2 \cdot 3r_1}{l_2 \cdot r_1} = 6 \Rightarrow \theta_2 = \frac{\theta_1}{6} = 10$$

29. (a) In a triangle ΔAMO ,

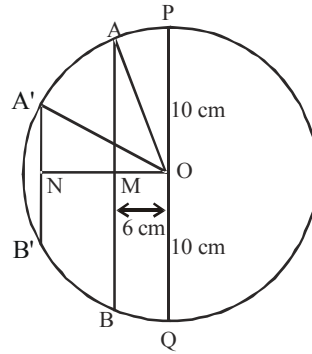

$$AM = \sqrt{10^2 - 6^2} = 8$$

Therefore, the length of the another chord $A'B' = 8$ cm.

Now, $A'N = 4$

In $\Delta OA'N$,

$$ON^2 = (OA')^2 - (A'N)^2 = 10^2 - 4^2 = 100 - 16 = 84$$

$$\Rightarrow ON = \sqrt{84}$$

30. (b) LCM of 48, 72, 108 = 432

the traffic lights will change simultaneously after 432 seconds or 7 min = in 12 secs.

\therefore they will change simultaneously at 8 : 27 : 12 hrs.

31. (d) Relative speed = $(40 - 20)$ km/h

$$= \left(20 \times \frac{5}{18} \right) \text{ m/sec} = \left(\frac{50}{9} \right) \text{ m/sec.}$$

Length of faster train

$$= \left(\frac{50}{9} \times 5 \right) \text{ m} = \frac{250}{9} \text{ m} = 27 \frac{7}{9} \text{ m.}$$

32. (b)

33. (d) $7 \sin^2 x + 3 \cos^2 x = 4$
or $7 \sin^2 x + 3(1 - \sin^2 x) = 4$

$$\text{or } 4 \sin^2 x + 3 = 4 \text{ or } \sin^2 x = \frac{1}{4} \text{ or } \sin x = \frac{1}{2} =$$

$\sin 30^\circ$

or $x = 30^\circ$

$$\therefore \tan x = \tan 30^\circ = \frac{1}{\sqrt{3}}$$

34. (b) $\tan A + \sin A = p$

and $\tan A - \sin A = q$

$$p^2 - q^2 = 4 \tan A \sin A$$

and $pq = \tan^2 A - \sin^2 A$
 $\Rightarrow pq = \frac{\sin^2 A(1 - \cos^2 A)}{\cos^2 A} = \tan^2 A \sin^2 A$
 $\Rightarrow \sqrt{pq} = \tan A \sin A$
 $\therefore p^2 - q^2 = 4\sqrt{pq}$

35. (b) $\frac{1 + \cos \theta}{1 - \cos \theta} \cdot \frac{(1 + \cos \theta)(1 + \cos \theta)}{1 - \cos^2 \theta}$
 $= \frac{1 + \cos^2 \theta + 2 \cos \theta}{\sin^2 \theta}$
 $= \operatorname{cosec}^2 \theta + \cot^2 \theta + 2 \cot \theta \cdot \operatorname{cosec} \theta$
 $= (\cot \theta + \operatorname{cosec} \theta)^2 = x^2$

36. (b) $\tan 62^\circ = \frac{P}{Q}$
 $\Rightarrow \tan (90^\circ - 28^\circ) = \frac{P}{Q} \Rightarrow \cot 28^\circ = \frac{P}{Q}$
 $\Rightarrow \frac{1}{\tan 28} = \frac{P}{Q} \Rightarrow \tan 28^\circ = \frac{Q}{P}$

37. (c) Let the height of the satellite be h .
 Let the two earth stations are at C and D .

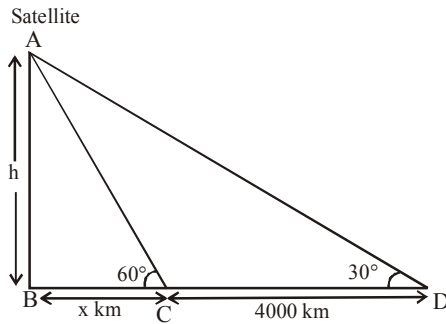

In $\triangle ABC$, $\tan 60^\circ = \frac{h}{x}$
 or $h = x \tan 60^\circ = x\sqrt{3}$... (i)
 In $\triangle ABD$, $\tan 30^\circ = \frac{h}{4000 + x}$
 or $h = \frac{4000 + x}{\sqrt{3}}$ or $h\sqrt{3} = 4000 + x$... (ii)
 From (i) and (ii), $4000\sqrt{3} = h\sqrt{3} + h\sqrt{3}$

or $h \left(\sqrt{3} - \frac{1}{\sqrt{3}} \right) = 4000$

or $h = \frac{4000\sqrt{3}}{3-1} = 2000\sqrt{3} \approx 3464 \text{ km.}$

38. (d) Average percentage growth of Assemble PCs

$\frac{20}{5} + \frac{25}{5} + \frac{25}{5} + \frac{50}{5} + \frac{55}{5} = \frac{175}{5} = 35\%$

39. (d) Number of Branded PCs sold in 1999

$= 100000 \times \frac{30}{10} = 300000$

40. (d)

41. (a) The production of first is done by the second.

42. (c) First is meant for the second.

43. (a): All except Sailor need raw material to work on.

44. (c): All others earn from the customer.

45. (b) ac a c/ab a b/a c a

c / aba b / a c a c

46. (d)

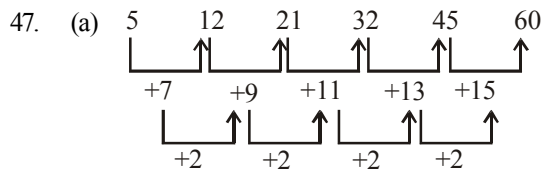

48. (d)

49. (b) C is the 3rd letter, F sixth, I ninth so next letter will be 12th, i.e. L.

The middle numerics are the squares of 2, 3, 4 and so on. So next numeric would be 25. The last letter follow the order : U is 3rd letter after R, X is 3rd after U. So, R would be 3rd letter after 'O'.
 \therefore Missing term = L25O.

50. (c) First number is increasing by 5, 7, 9, 11, 13....

Second letter is decreasing by 1 position. Third number is increasing by 2.

51. (c) 52. (b)

53. (c) Raj Kumar's sister's father in law's son is Rajkumar's sister's husband. Therefore, Raj kumar's sister's husband is Raj Kumar's father's son-in-law.

54. (a) C and D are children of A and B. B is mother of C and D. Therefore, B is sisters-in-law of E.

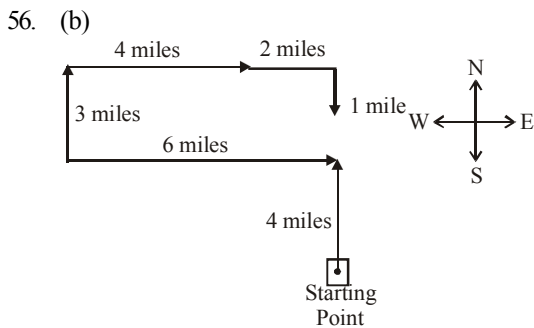
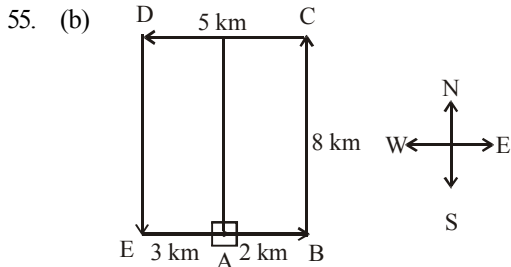

Now the man is facing towards south.

57. (d) $A > B > E$... (i)
 $C > A > D > B$... (ii)
 From statements (i) and (ii)

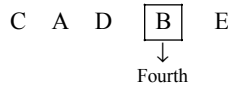

58. (c) $Q > P$... (i)
 $T > R > Q$... (ii)
 Combining these two statements.
 $T > R > Q > P$
 Clearly, R scored the second highest.

59. (c) S T R A N G U L A
 T I O N

60. (d) There is only one 'E' in the given word.

61. (c) Meaningful order of the words:

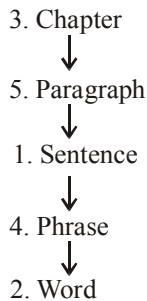

62. (d) Arrangement of the words as per dictionary

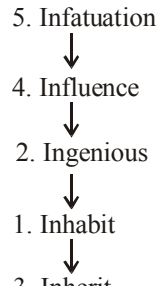

63. (a) 1st January was Friday.
 First Wednesday \Rightarrow 6th January
 Fourth Wednesday \Rightarrow 27th January
 Three days after January 27 \Rightarrow 30th January

64. (c) According to Mohit: Apr 18 or earlier ... (i)
 According to his sister: April 18 or 19 ... (ii)
 From (i) and (ii), we get Apr 18.

65. (a) 30th September 1998 \Rightarrow Wednesday
 30th September 1999 \Rightarrow Thursday
 30th September 2000 \Rightarrow Saturday
 Because 2000 is a Leap Year and there is one extra day in the month of February.
 30th September 2001 \Rightarrow Sunday
 30th September 2002 \Rightarrow Monday
 30th September 2003 \Rightarrow Tuesday

66. (b) Each second-space equals 1° .
 A clock gains five minutes every hour.

It means the clock gains $\frac{5}{60}$ minutes in one minute.

$$\frac{5}{60} \times 360 = 30$$

The second hand will traverse 360.5° in one minute.

67. (c) Judge is different from both the thief and criminal.
 The thief comes under the class criminal.

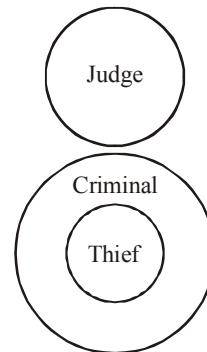

68. (c) 25 have VCRs and each VCR owner also has a TV.
Therefore, the TV owners who have not VCRs $75 - 25 = 50$.
Now, 10 have all the three. Therefore, $50 - 10 = 40$ have only TV.

69. (d) Both the Premises are Particular Affirmative (I-type). No conclusion follows from the two particular Premises.
70. (d) From general statements, Universal Conclusion cannot be drawn.

71. (c) $\sqrt{324}$ 18; $\sqrt{289}$ 17
 $18 + 17 = 35$
 $\sqrt{441}$ 21; $\sqrt{484}$ 22
 $21 + 22 = 43$
 $\sqrt{625}$ 25; $\sqrt{400}$ 20
 $25 + 20 = 45$
 $\sqrt{256}$ 16; $\sqrt{729}$ 27
 $16 + 27 = 43$

72. (c)
73. (a) Age of Shan = 55 years
Age of Sathian = $55 - 5 = 50$ years
Age of Balan = $50 - 6 = 44$ years
Age of Devan = $44 - 7 = 37$ years
Difference between the ages of Shan and Devan.
 $= 55 - 37 = 18$ years

74. (c) Suppose his present age is x years.
According to question
 $\frac{x}{4} + \frac{x}{5} + \frac{x}{3} = x - 13$
 $\Rightarrow \frac{15x + 12x + 20x}{60} = x - 13$
 $\Rightarrow 47x = 60x - 780$
 $\Rightarrow 60x - 47x = 780$
 $\Rightarrow 13x = 780$
 $\therefore x = \frac{780}{13} = 60$ years

75. (b) B \Rightarrow 04, 11, 23, 30, 42
U \Rightarrow 58, 65, 77, 89, 96
S \Rightarrow 57, 69, 76, 88, 95
H \Rightarrow 03, 10, 22, 34, 41

Option	B	U	S	H
(a)	22	77	57	23
(b)	23	77	57	22
(c)	23	77	56	22
(d)	23	77	57	21

76. (d) If we fold the option (a) the number 2 will lie opposite 5.
If we fold the option (b) the number 1 will lie opposite 3.
If we fold the option (c) the number 2 will lie opposite 5.
Therefore, Answer Figure (d) is correct.

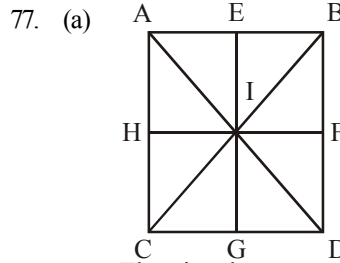

- The triangles are:
 $\triangle AIH$; $\triangle AIE$; $\triangle EIB$; $\triangle BFI$;
 $\triangle IHC$; $\triangle IGC$; $\triangle IGD$; $\triangle DFI$;
 $\triangle IAB$; $\triangle IBD$; $\triangle ICD$; $\triangle IAC$;
 $\triangle IBC$; $\triangle IDA$;
78. (b) 79. (b)
80. (c) 1 starts with one quadrant, has another one in fig. 3; this second quadrant moves clockwise equal to one side of the square to arrive at positions in fig. 2, then fig. 4 and then finally to overlap in fig 5
81. (b) 82. (c) 83. (c) 84. (a) 85. (c)
86. (a) 87. (d) 88. (a) 89. (c) 90. (a)
91. (c) 92. (b) 93. (b) 94. (d) 95. (b)
96. (d) 97. (d) 98. (c) 99. (a) 100. (c)
101. (b) 102. (d) 103. (a) 104. (c) 105. (a)
106. (d) 107. (b) 108. (d)
109. (c) Santosh Yadav is an Indian mountaineer. She is the first woman in the world to climb Mount Everest twice in less than a year. She first climbed the peak in May 1992 and then did it again in May 1993.
110. (b) At present all important steel plants except TISCO (Tata Iron and Steel co. Ltd) which is located in Jamshedpur are under public sector.
111. (b) 112. (a) 113. (b) 114. (a) 115. (c)
116. (b) 117. (a) 118. (b) 119. (d) 120. (a)

ARITHMETIC

1. In a 225 meter long yard 26 trees are planted at equal distance, one tree being at each end of the yard. What is the distance between two consecutive trees?
(a) 10 meters (b) 8 meters
(c) 12 meters (d) 9 meters
2. A boy was asked to multiply a number by 25. Instead, he multiplied the number by 52 and got the answer 324 more than the correct answer. The number to be multiplied was
(a) 12 (b) 15
(c) 25 (d) 32
3. The number whose square is equal to the difference of the squares of 40 and 32 is
(a) 45.09 (b) 24
(c) 25 (d) 28
4. In a fort there was sufficient food for 200 soldiers for 31 days. After 27 days, 120 soldiers left the fort. For how many extra days will the rest of the food last for the remaining soldiers?
(a) 12 days (b) 10 days
(c) 8 days (d) 6 days
5. 7 is added to a certain number, the sum is multiplied by 5; the product is divided by 9 and 3 is subtracted from the quotient. The remainder left is 12. What is the number?
(a) 20 (b) 30
(c) 40 (d) 5
6. If the selling price of an article is $\frac{4}{3}$ of its cost price, the profit in transaction is
(a) 16.75% (b) 20.50%
(c) 25.50% (d) 33.33%
7. In an election between two candidates, 70% of the voters cast their votes, out of which 2% of the votes were declared invalid. A candidate got 7203 votes which was 60% of the total valid votes. Find the total number of voters enrolled in that election.
(a) 18050 (b) 17500
(c) 17000 (d) 7203
8. A man purchased a bullock and a cart for ₹ 1800. He sold the bullock at a profit of 20% and the cart at a profit of 30%. His total profit was $155\frac{5}{6}$ %. Find the cost price of bullock.
(a) ₹ 650 (b) ₹ 750
(c) ₹ 900 (d) ₹ 800
9. If a sum becomes double in 16 years, how many times will it be in 8 years?
(a) $1\frac{1}{2}$ times (b) $1\frac{1}{3}$ times
(c) $1\frac{3}{4}$ items (d) $1\frac{1}{4}$ times
10. A's salary is 20% lower than B's salary, which is 15% lower than C's salary. By how much percent is C's salary more than A's salary?
(a) 44.05% (b) 45.05%
(c) 46.05% (d) 47.05%
11. 'A' and 'B' can do a piece of work in 30 days while 'B' and 'C' can do the same work in 24 days and 'C' and 'A' in 20 days. They all work for 10 days and 'B' and 'C' leave. How many days more will 'A' take to finish the work?
(a) 12 days (b) 18 days
(c) 20 days (d) 22 days
12. A man can row $9\frac{1}{3}$ Kmph in still water and finds that it takes him thrice as much time to row up than as to row down the same distance in the river. The speed of the current is
(a) $3\frac{1}{3}$ Kmph (b) $3\frac{1}{9}$ Kmph
(c) $4\frac{2}{3}$ Kmph (d) $4\frac{1}{3}$ Kmph
13. ₹ 800 becomes ₹ 956 in 3 years at a certain rate of interest. If the rate of interest is increased by 4% what amount will ₹ 800 become in 3 years?
(a) ₹ 1020 (b) ₹ 1052
(c) ₹ 1282 (d) ₹ 1080
14. If the manufacturer gains 10%, the wholesale dealer gains 15% and the retailer gains 25%, find the cost of production of a table. The retail price of table is ₹ 1265
(a) ₹ 800 (b) ₹ 1000
(c) ₹ 950 (d) ₹ 1180

15. Ram borrows ₹ 8000 at 12% p.a. simple interest and Mohan borrows ₹ 9100 at 10% p.a. simple interest. In how many years will their borrowed amounts (debt) be equal?
 (a) 18 (b) 20
 (c) 22 (d) 24
23. The value of k for which the line $x + 2y = 9$ and $kx + 4y = -5$ are parallel is
 (a) $k = 2$ (b) $k = 1$
 (c) $k = -1$ (d) $k = 3$
24. There are 60 terms in an A.P. of which the first term is 8 and the last term is 185. The 31st term is
 (a) 56 (b) 94
 (c) 85 (d) 98

DIRECTIONS (Q. 16): What approximate value should come in place of the question mark (?) in the following questions? (Note : You are not expected to calculate the exact value.)

16. $8787 \div 343 \times \sqrt{50} = ?$
 (a) 250 (b) 140
 (c) 180 (d) 100
17. Average age of 36 children of the class is 15 years. 12 more children joined whose average age is 16 years. What is the average age of all the 48 children together?
 (a) 15.25 years (b) 15.5 years
 (c) 15.3 years (d) 15.4 years
18. A right circular cone and a right circular cylinder have equal base and equal height. If the radius of the base and the height are in the ratio 5 : 12, then the ratio of the total surface area of the cylinder to that of the cone is
 (a) 3 : 1 (b) 13 : 9
 (c) 17 : 9 (d) 34 : 9
19. Of the following quadratic equations, which is the one whose roots are 2 and -15 ?
 (a) $x^2 - 2x + 15 = 0$ (b) $x^2 + 15x - 2 = 0$
 (c) $x^2 + 13x - 30 = 0$ (d) $x^2 - 30 = 0$
20. Which of the following equations has real roots?
 (a) $3x^2 + 4x + 5 = 0$
 (b) $x^2 + x + 4 = 0$
 (c) $(x - 1)(2x - 5) = 0$
 (d) $2x^2 - 3x + 4 = 0$
21. If $\frac{3-5x}{x} + \frac{3-5y}{y} + \frac{3-5z}{z} = 0$, the value of $\frac{1}{x} + \frac{1}{y} + \frac{1}{z}$ is
 (a) -5 (b) 5
 (c) 2 (d) 3
22. If $a + b + c = 2s$ then find the value of $(s-a)^3 + (s-b)^3 + 3(s-a)(s-b)c$ is
 (a) c (b) c^2
 (c) c^3 (d) $2c^2$
25. ABCD is a cyclic quadrilateral, AB is a diameter of the circle. If $\angle ACD = 50^\circ$, the value of $\angle BAD$ is
 (a) 30° (b) 40°
 (c) 50° (d) 60°
26. D and E are the mid-points of AB and AC of $\triangle ABC$. If $\angle A = 80^\circ$, $\angle C = 35^\circ$, then $\angle EDB$ is equal to
 (a) 100° (b) 115°
 (c) 120° (d) 125°
27. The perimeters of two similar triangles ABC and PQR are 36 cm, and 24 cm, respectively. If PQ = 10 cm, then the length of AB is :
 (a) 16 cm (b) 12 cm
 (c) 14 cm (d) 15 cm
28. Two isosceles triangles have equal vertical angles and their areas are in the ratio 9 : 16. The ratio of their corresponding heights is :
 (a) 3 : 4 (b) 4 : 3
 (c) 2 : 1 (d) 1 : 2
29. In a circle of radius 17 cm, two parallel chords are drawn on opposite sides of a diameter. The distance between the chords is 23 cm. If length of one chord is 16 cm, then the length of the other one is:
 (a) 15 cm (b) 23 cm
 (c) 30 cm (d) 34 cm
30. Two numbers are in the ratio of 15 : 11. If their H.C.F. is 13, find the numbers.
 (a) 195, 11 (b) 195, 143
 (c) 195, 15 (d) 143, 13
31. The speed of a boat in still water is 15 km/h and the rate of stream is 5 km/h. The distance travelled downstream in 24 minutes is
 (a) 4 km (b) 8 km
 (c) 6 km (d) 16 km
32. If $x = r \sin \theta \cos \phi$, $y = r \sin \theta \sin \phi$, $z = r \cos \theta$, then $x^2 + y^2 + z^2$ is equal to
 (a) $r^2 \cos^2 \phi$ (b) $r^2 \sin^2 \theta + r^2 \cos^2 \phi$
 (c) r^2 (d) $\frac{1}{r^2}$

33. If $\cot \theta = \frac{7}{24}$ and $\pi < \theta < \frac{3\pi}{2}$, then the value of $\cos \theta - \sin \theta$ is
 (a) $\frac{19}{25}$ (b) $\frac{18}{35}$
 (c) $\frac{17}{25}$ (d) $\frac{18}{25}$
34. If $x + y = z$, find the value of $\cos^2 x + \cos^2 y + \cos^2 z$.
 (a) $1 + 2 \sin x \sin y \sin z$
 (b) $1 - 2 \sin x \sin y \sin z$
 (c) $1 + 2 \cos x \cos y \cos z$
 (d) $1 - 2 \cos x \cos y \cos z$
35. If $\sin^2 x + \sin x = 1$, then the value of $\cos^{12} x + 3 \cos^{10} x + 3 \cos^8 x + \cos^6 x - 1$ is equal to
 (a) 1 (b) 0
 (c) -1 (d) 2
36. If $3 \sin \theta + 5 \cos \theta = 4$, then $(3 \cos \theta - 5 \sin \theta)$ is equal to
 (a) 2 (b) $\pm 3\sqrt{2}$
 (c) 5 (d) 8
37. The angle of elevation of the top of a tower from two points at distances m and n metres are complementary. If the two points and the base of the tower are on the same straight line, then the height of the tower is :
 (a) \sqrt{mn} metres (b) mn metres
 (c) $\frac{m}{n}$ metres (d) None of these

DIRECTIONS (Qs. 38-40) : Study the following graph to answer the given questions.

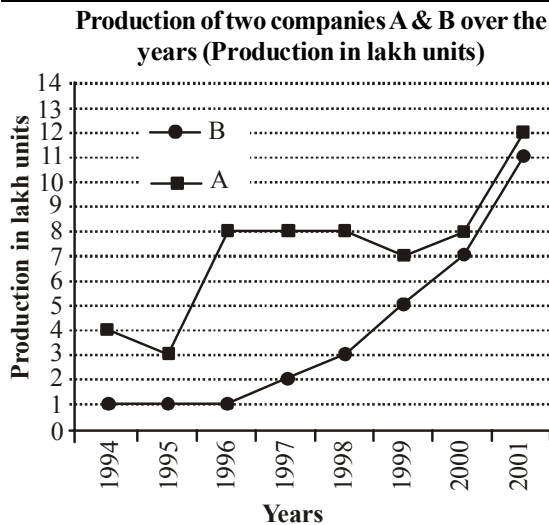

38. For Company A, what is the per cent decrease in production from 1994 to 1995?
 (a) 75 (b) 50
 (c) 25 (d) 10
39. In 2001, the production of Company B is approximately what per cent of that in 2000?
 (a) 60 (b) 157
 (c) 192 (d) 50
40. For Company A, in which year is the percentage increase/decrease in the production from the previous year the highest?
 (a) 2001 (b) 1995
 (c) 1999 (d) 1996

GENERAL INTELLIGENCE & REASONING

DIRECTIONS (Qs. 41-42) : In each of the following questions, select the related word/letters/number from the given alternatives :

41. Spider : Insect :: Crocodile : ?
 (a) Reptile (b) Mammal
 (c) Frog (d) Carnivore
42. Steel : Alloy :: Zinc : ?
 (a) Metal (b) Non-metal
 (c) Salt (d) Halogen

DIRECTIONS (Qs. 43-44) : In each of the following questions, four words have been given, out of which three are alike in some manner and the fourth one is different. Choose out the odd one.

43. (a) Travelled (b) Sailed
 (c) Walked (d) Rode
44. (a) Car (b) Autorickshaw
 (c) Van (d) Taxi

DIRECTIONS (Q. 45) : In each of the following questions, a series is given, with one/two term(s) missing. Choose the correct alternative from the given ones that will complete the series.

45. WTPMIFB ? ?
 (a) ZV (b) XU
 (c) YU (d) YV
46. In the following question, number of letters are skipped in between by a particular rule. Which of the following observes the rule?
 (a) ACZXFG (b) CFXURI
 (c) CFIURX (d) CXFUIR

DIRECTIONS (Qs. 47-48): In each of the following questions select the missing number from the given responses.

47.

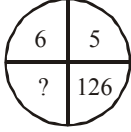

- (a) 127 (b) 31
(c) 217 (d) 328

48.

2	1	2
21	22	?
1	2	5
20	23	43

- (a) 40 (b) 48
(c) 50 (d) 36

DIRECTIONS (Qs. 49-50): In each of the following questions various terms of a series are given with one term missing as shown by (?). Choose the missing term.

49. J2Z, K4X, I7V, ?, H16R, M22P

- (a) I11T (b) L11S
(c) L12T (d) L11T

50. Q1F, S2E, U6D, W21C, ?

- (a) Y66B (b) Y44B
(c) Y88B (d) Z88B

51. If DELHI is coded as 73541 and CALCUTTA as 82589662, then how can CALICUT be coded?

- (a) 5279431 (b) 5978013
(c) 8251896 (d) 8543691

52. If in a certain language, PLAYER is coded as QNDCJX, then how SINGER will be coded in the same language?

- (a) TKQKJX (b) TKJKQX
(c) TKQKXJ (d) TKQXJK

53. Pointing to a photograph Vikas said "She is the daughter of my grandfather's only son". How is the related to Vikas in the photograph?

- (a) Father (b) Brother
(c) Sister (d) Mother

54. M is the son of P. Q is the granddaughter of O who is the husband of P. How is M related to O?

- (a) Son (b) Daughter
(c) Mother (d) Father

55. Siddharth and Murali go for jogging from the same point. Siddharth goes towards the east covering 4 kms. Murali proceeds towards the

West for 3 kms. Siddharth turns left and covers 4 kms and Mxurali turns to the right to cover 4 kms. Now what will be the distance between Siddharth and Murali?

- (a) 14 kms (b) 6 kms
(c) 8 kms (d) 7 kms

56. A rat run 20' towards East and turns to right runs 10', and turns to right turns 9', and again turns to left runs 5' and then turns to left runs 12' and finally turns to left and runs 6'. Now what direction is the rat facing?

- (a) EAST (b) NORTH
(c) WEST (d) SOUTH

57. A, B, C, D, E, F & G are sitting in line facing the East. C is immediate right of D. B is at an extreme end and has E as his neighbour. G is between E and F. D is sitting third from the south end. Who are the persons sitting at the extreme ends?

- (a) A & E (b) A & B
(c) F & B (d) C & D

58. Five boys are sitting in a row, A is on the right of B, E is on the left of B, but to the right of C. If A is on the left D, who is sitting in the middle?

- (a) E (b) B
(c) A (d) C

59. From the given alternative words, select the word which can be formed using the letters of the given word:

'DETERMINATION'

- (a) DECLARATION (b) NATIONAL
(c) TERMINATED (d) DEVIATION

60. From the given alternative words. Select the word which **cannot** be formed using the letters of the given word:

'REFORMATION'

- (a) REFRAIN (b) MOTION
(c) REFRACT (d) FORMAT

61. Arrange the following words as per order in the dictionary.

1. Dissident 2. Dissolve
3. Dissent 4. Dissolute
5. Dissolution

- (a) 3, 1, 4, 5, 2 (b) 3, 2, 1, 4, 5
(c) 3, 1, 4, 2, 5 (d) 3, 2, 4, 5, 1

62. Arrange the following words as per order in dictionary.

1. Noble 2. Nobilitary
3. Noblesse 4. Nobility
5. Nobble

- (a) 1, 4, 3, 2, 5 (b) 3, 4, 1, 2, 5
(c) 5, 2, 4, 1, 3 (c) 2, 4, 3, 5, 1

63. Meena correctly remembers that her father's birthday is after eighteenth May but before twentysecond May. Her brother correctly remembers that their father's birthday is before twenty-fourth May but after twentieth May. On which date in May was definitely their father's birthday?

- (a) Twentieth (b) Nineteenth
(c) Eighteenth (d) None of these

64. Nitin correctly remembers that Nidhi's birthday is before Friday but after Tuesday. Derek correctly remembers that Nidhi's birthday is after Wednesday but before Saturday. On which of the following day does Nidhi's birthday definitely fall?

- (a) Monday (b) Tuesday
(c) Wednesday (d) Thursday

65. If John celebrated his victory day on Tuesday, 5th January 1965, when will he celebrate his next victory day on the same day?

- (a) 5th January 1970 (b) 5th January 1971
(c) 5th January 1973 (d) 5th January 1974

66. After 9'O clock at what time between 9 p.m and 10 p.m. will the hour and minute hands of a clock point in opposite direction?

- (a) 15 minutes past 9
(b) 16 minutes past 9
(c) $16\frac{4}{11}$ minutes past 9
(d) $17\frac{1}{11}$ minutes past 9

67. Which of the following diagrams represents the relationship among Sun, Moon and Star?

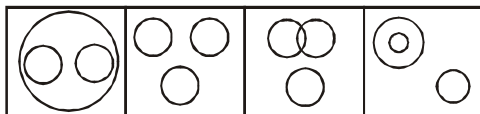

- (a) (b) (c) (d)

68. In a survey of a town, it was found that 65% of the people surveyed watch the news on T.V., 40% read a newspaper and 25% read a newspaper and watch the news on T.V. What per cent of the people surveyed neither watch the news on T.V. nor read a newspaper?

- (a) 5% (b) 10%
(c) 20% (d) 15%

DIRECTIONS (Qs. 69-70): In each of the following question, two statements are given followed by conclusion I, II or more. You have to consider the statements to be true, even if they seem to be at variance from commonly known facts. You are to decide which of the given conclusions definitely follows from the given statements.

69. **Statements:**

1. All students are girls.
2. No girl is dull.

Conclusions:

- I. There are no boys in the class.
II. No student is dull.
(a) Only conclusion II follows.
(b) Both conclusions I and II follow.
(c) Neither conclusion I nor conclusion II follows.
(d) Only conclusion I follows.

70. **Statements:**

1. All teachers are aged.
2. Some women are teachers.

Conclusions:

- I. All aged are women.
II. Some women are aged.
(a) Only conclusion I follows.
(b) Only conclusion II follows.
(c) Neither conclusion I nor II follows.
(d) Both conclusions I and II follow.

71. Some equations have been solved on the basis of certain system. Find the correct answer for the unsolved equation on that basis. If $94 + 16 = 42$, $89 + 23 = 78$, then $63 + 45 = ?$

- (a) 18 (b) 28
(c) 38 (d) 48

72. If '-' stands for '÷' '+' stands for '×' '÷' for '-' and '×' , which one of the following equations is correct?

- (a) $30 - 6 + 5 \times 4 \div 2 = 27$
(b) $30 + 6 - 5 \div 4 \times 2 = 30$
(c) $30 \times 6 \div 5 - 4 + 2 = 32$
(d) $30 \div 6 \times 5 + 4 - 2 = 40$

73. In a certain office, $\frac{1}{3}$ of the workers are women,

$\frac{1}{2}$ of the women are married and $\frac{1}{3}$ of the married

women have children. If $\frac{3}{4}$ of the men are married

and $\frac{2}{3}$ of the married men have children, then what part of workers are without children?

- (a) $\frac{5}{18}$ (b) $\frac{4}{9}$
 (c) $\frac{11}{18}$ (d) $\frac{17}{36}$

74. In a family, mother's age is twice that of daughter's age. Father is 10 years older than mother. Brother is 20 years younger than his mother and 5 years older than his sister. What is the age of the father?
 (a) 62 years (b) 60 years
 (c) 58 years (d) 55 years

DIRECTIONS (Qs. 75) : A word is represented by only one set of numbers as given in any one of the alternatives. The sets of numbers given in the alternatives are represented by two classes of alphabets as shown in two matrices given below. The columns and rows of Matrix I are numbered from 0 to 4 and that of Matrix II are numbered from 5 to 9. A letter from these matrices can be represented first by its row and next by its column, e.g.

75. 'F' can be represented by 14, 21, etc. 'S' can be represented by 58, 96, etc. Similarly, identify the word TRIP.

MATRIX-I

	0	1	2	3	4
0	D	E	F	I	N
1	I	N	D	E	F
2	E	F	I	N	D
3	N	D	E	F	I
4	F	I	N	D	E

MATRIX-II

	5	6	7	8	9
5	O	P	R	S	T
6	S	T	O	P	R
7	P	R	S	T	O
8	T	O	P	R	S
9	R	S	T	O	P

- (a) 78, 76, 21, 76 (b) 59, 57, 41, 56
 (c) 85, 88, 33, 89 (d) 66, 69, 40, 69

76. Three position of a dice are given. Find out which number is found opposite the number 2 in given cube.

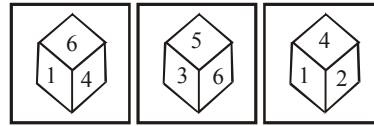

- (a) 6 (b) 5
 (c) 3 (d) 1
77. How many rectangles are there in the given diagram?

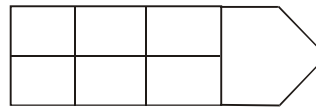

- (a) 4 (b) 7
 (c) 9 (d) 18
78. In the question, part one of the problem figure is subtracted. Select the option that shows the correct shape after subtraction.

Question Figure:

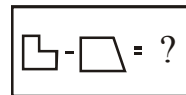

Answer Figure:

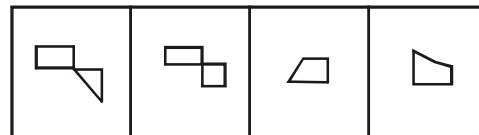

- (a) (b) (c) (d)

DIRECTION (Q. 79) : In the following questions, a square sheet of paper is folded along the dotted lines and then cuts are made on it. How would the sheet look when opened? Select the correct figure from the given choices.

79.
 (a) (b) (c) (d)

DIRECTIONS (Q.80) : In each of the following questions there are given five figures. If two of these figures are interchanged in a question, the five figures are arranged in a certain order. You have to select from the four given alternatives the correct answer for each question.

80.

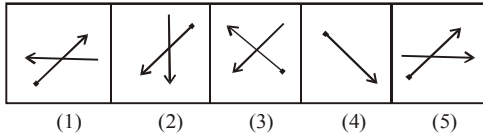

- (a) 1,2 (b) 1,3
(c) 2,4 (d) 2,4

GENERAL AWARENESS

81. Soft copy refers to
- (a) printed output (b) music sounds
(c) screen output (d) digitizing
82. A program that enables you to perform calculations involving rows and columns of numbers is called a
- (a) spreadsheet program
(b) word processor
(c) graphics package
(d) window
83. WWW stands for
- (a) World Work Web (b) Wide Work Web
(c) Wide World Web (d) World Wide Web
84. The physical components of a computer system is
- (a) Software (b) Hardware
(c) ALU (d) Control Unit
85. Which is a graphical representation of an application?
- (a) Windows 95
(b) Windows Explorer
(c) Icon
(d) Taskbar
86. Which of the following provides essential security for a computer network?
- (a) Firewall (b) Fire screen
(c) Fireguard (d) Fire line
87. What is liveware?
- (a) Misspelled, it must be live wire.
(b) Software embedded into the hardware.
(c) The users working on the computer system.
(d) A computer in perfect working condition.
88. Who won the Gyanpith award for the first time and when was it?
- (a) G Sankara Kurup in 1965
(b) G Sankara Kurup in 1971
(c) Tara Shankar Banerjee in 1965
(d) Tara Shankar Banerjee in 1971
89. Aardvark is one of the first word in English dictionary. What does it mean or what is it?
- (a) a nocturnal mammal of South Africa
(b) a vulture of South America
(c) Name of an ancient civilization
(d) A devil in the mythology
90. What is silverfish?
- (a) A silvery freshwater fish
(b) Leaf of silver oak
(c) A small silvery wingles insect
(d) An American fox with a silvery fur
91. Which of the following is correct?
- (a) Osteology is the study of bones
(b) Philately is the study of coins
(c) Limnology is the study of oceans
(d) Ethology is the study of human races.
92. Which of the following is not correct?
- (a) Ammeter measures the strength of electric current.
(b) Lactometer measures the relative density of milk.
(c) Rain gauge measures rain fall.
(d) Hygrometer measures sound under water.
93. Which of the following is the unit of distance in navigation?
- (a) Knot (b) Nautical mile
(c) Bar (d) Angstrom
94. The only country in the world where home delivery and redirection of postal articles exists:
- (a) Brazil (b) England
(c) India (d) Romanca
95. Which prefix is often used with scientific terms to indicate that something is the same, equal or constant?
- (a) iso (b) mega
(c) meta (d) quasi
96. The study of phenomena at very low temperatures is called
- (a) heat transfer (b) morphology
(c) crystallography (d) cryogenics
97. The branch of medical science which is concerned with the study of disease as it affects a community of people is called
- (a) epidemology (b) oncology
(c) paleontology (d) pathology

98. Superconductivity is a material property associated with
 (a) cooling a substance without a phase change
 (b) frictionless liquid flow
 (c) a loss of thermal resistance
 (d) a loss of electrical resistance
99. If a metal can be drawn into wires relatively easily it is called
 (a) malleable (b) ductile
 (c) extractive (d) tactile
100. Cystitis is the infection of which of the following?
 (a) liver (b) urinary bladder
 (c) pancreas (d) lung
101. Which of the following is primarily composed of calcium carbonate?
 (a) Fish scales (b) Shark teeth
 (c) Oyster Shells (d) Whale bones
102. Water flows through a horizontal pipe at a constant volumetric rate. At a location where the cross sectional area decreases, the velocity of the fluid
 (a) increases (b) decreases
 (c) stays the same (d) none of the above
103. Yeast, used in making bread is a
 (a) fungus (b) plant
 (c) bacteria (d) seed
104. A cyclone is an engineering device that is used to
 (a) transport materials
 (b) segregate particles
 (c) control switching devices
 (d) model fractals
105. A gas used as a disinfectant in drinking water is
 (a) Hydrogen (b) Oxygen
 (c) Fluorine (d) Chlorine
106. Which is the longest bone in the human body?
 (a) Fibula (b) Radius
 (c) Stapes (d) Femur
107. The Baglihar Hydroelectric power project in J & K is built across the river.
 (a) Beas (b) Chenab
 (c) Jhelum (d) Sutlej
108. Which among the following is not a gallantry medal?
 (a) Ashok Chakra (b) Arjuna Award
 (c) Param Vir Chakra (d) Shaurya Chakra
109. Which computer was the first to use the magnetic drum for memory?
 (a) IBM - 650 (b) IBM - 7090
 (c) IBM - 701 (d) IBM - 360
110. When a particle and an antiparticle come in contact with each other, they
 (a) repel each other
 (b) annihilate each other
 (c) go undisturbed
 (d) spin about a common axis
111. How do most insects respire?
 (a) Through skin (b) Through gills
 (c) By tracheal system (d) By lungs
112. The drainage pattern developed on folded sedimentary rock is termed as
 (a) Trellis (b) Dendritic
 (c) Radial (d) Deranged
113. One of these trains connects Mumbai and Aurangabad. Name it.
 (a) Sabarmati Express (b) Deviri Express
 (c) Ashram Express (d) Janata Express
114. Which Railway Zone has introduced Biodiesel for train operations?
 (a) Western Railway
 (b) Central Railways
 (c) South Western Railways
 (d) Southern Railways
115. Where is the Indian Railways Institute of Civil Engineering Institute situated?
 (a) Pune (b) Chennai
 (c) Nasik (d) Sikandrabad
116. Name the robot who created a new record by solving the famous rubik's cube puzzle.
 (a) Sub1 (b) Icuber
 (c) Tilted Twister (d) RuBot2
117. What is the Theme of 2016 World Pneumonia Day?
 (a) Keep the Promise, Stop Pneumonia Now
 (b) We Think We Can
 (c) Stop Pneumonia for Better Life
 (d) Promise To Stop Pneumonia
118. Economic Editors' Conference-2016 was organized in which state?
 (a) Haryana (b) New delhi
 (c) Maharashtra (d) Punjab
119. Prime Minister Narendra Modi has inaugurated the first ever International Agro-biodiversity Congress, (IAC) in which city on November 6, 2016?
 (a) Udaipur (b) Chennai
 (c) New Delhi (d) Hyderabad
120. What are the currency notes would no longer be legal tender from midnight 8th November 2016 announced by the PM Narendra Modi?
 (a) ₹ 50 and ₹ 1000 (b) ₹ 500 and ₹ 100
 (c) ₹ 500 and ₹ 1000 (d) ₹ 50 and ₹ 100

Hints & Explanations

1. (d) Distance between two consecutive trees

$$= \frac{225}{25} = 9 \text{ meters.}$$

2. (a) Let the number be x .

$$25x + 324 = 52x$$

$$52x - 25x = 324$$

$$27x = 324$$

$$x = 12$$

3. (b) $(40)^2 - (32)^2 = 1600 - 1024 = 576$

Hence, 24 is the required number.

4. (b) Let rest of the food last for the x days.

$$\therefore 200 \times 4 = (200 - 120) \times x$$

$$200 \times 4 = 80 \times x$$

$$x = \frac{800}{80} = 10 \text{ days.}$$

5. (a) Let the number be x

$$\frac{5(7+x)}{9} - 3 = 12$$

$$\frac{5(7+x)}{9} = 15$$

$$7+x = \frac{15 \times 9}{5} = 27$$

$$x = 27 - 7 = 20$$

6. (d) Let C.P. = ₹ x , then S.P. = ₹ $\frac{4x}{3}$

$$\text{Gain} = ₹ \left(\frac{4x}{3} - x \right) = ₹ \frac{x}{3}$$

$$\therefore \text{Gain \%} \left(\frac{\frac{x}{3}}{x} \times 100 \right) = 33.33\%$$

7. (b) Let the total number of votes enrolled be x .

Then, number of votes cast = 70% of valid

votes = 98% of (70% of x)

$$60\% \text{ of } [98\% \text{ of } 70\% \text{ of } x] = 7203$$

$$\frac{70}{100} \times \frac{98}{100} \times \frac{60}{100} \times x = 7203$$

$$x = \frac{7203 \times 100 \times 100 \times 100}{70 \times 98 \times 60}$$

$$x = 17500$$

8. (b) Let CP of bullock = ₹ x

$$\text{SP} = \frac{x \times 120}{100}$$

$$\text{CP of cart} = (1800 - x)$$

$$P = 30\%$$

$$\text{SP} = \frac{(1800 - x) \times 130}{100}$$

$$\begin{aligned} \text{Total SP} &= \frac{1800 \times \left(100 + \frac{155}{6} \right)}{100} \\ &= ₹ 226500 \end{aligned}$$

$$\therefore \frac{120}{100} + \frac{(1800 - x) \times 130}{100} = 226500$$

$$\therefore x = 750$$

Hence, cost price of bullock = ₹ 750

9. (a) S.I. = $2P - P = P$

$$P = \frac{P \times R \times 16}{100}$$

$$R = \frac{25}{4} \%$$

$$\text{(S.I.) For 8 years} = \frac{P \times \frac{25}{4} \times 8}{100} = \frac{P}{2}$$

$$\text{Amount} = P + \frac{P}{2} = \frac{3P}{2}$$

Amount increased by $1\frac{1}{2}$ times.

10. (d) $A = B - 20\% \text{ of } B = 0.8B$

$$B = C - 15\% \text{ of } C = 0.85C$$

$$A = 0.8 \times 0.85C = 0.68C$$

$$\begin{aligned} \frac{C - A}{A} \times 100 &= \frac{C - 0.68C}{0.68C} \times 100 = \frac{32}{68} \times 100 \\ &= 49.05\% \end{aligned}$$

11. (b) Let A, B and C individually complete the work in x, y and z days respectively.

$$\frac{1}{x} + \frac{1}{y} = \frac{1}{30} \quad \dots(1)$$

$$\frac{1}{y} + \frac{1}{z} = \frac{1}{24} \quad \dots(2)$$

$$\frac{1}{z} + \frac{1}{x} = \frac{1}{20} \quad \dots(3)$$

adding equ (1), (2) and (3)

$$2\left(\frac{1}{x} + \frac{1}{y} + \frac{1}{z}\right) = \frac{1}{8} \Rightarrow \frac{1}{x} + \frac{1}{y} + \frac{1}{z} = \frac{1}{16} \quad \dots(4)$$

A, B and C together complete the work in 16 days.

In 10 days they completed $\frac{10}{16} = \frac{5}{8}$ Part

$$\text{Remaining work} = 1 - \frac{5}{8} = \frac{3}{8}$$

Subtracting equ (2) from (4)

$$\text{we get, } \frac{1}{x} = \frac{1}{48} \text{ or } x = 48$$

A alone can finish the Remaining work in

$$\frac{3}{8} \times 48 = 18 \text{ days}$$

12. (c) Distance covered by man = D Km
Speed of Man in still water = x Kmph

$$\text{Speed of current} = \frac{28}{3} \text{ Kmph}$$

According to question,

$$\frac{D}{\frac{28}{3} - x} = 3 \left(\frac{D}{\frac{28}{3} + x} \right)$$

$$\Rightarrow \frac{28}{3} + x = 3 \left(\frac{28}{3} - x \right) \Rightarrow 4x = 2 \times \frac{28}{3}$$

$$\Rightarrow x = \frac{14}{3} \text{ or } 4\frac{2}{3} \text{ Kmph}$$

13. (b) S.I. = ₹ (956 - 800) = ₹ 156;
P = 800, T = 3 yrs.

$$\therefore R = \left(\frac{100 \times 156}{800 \times 3} \right) \% = 6.5\%$$

$$\text{New rate} = (6.5 + 4) = 10.5\%$$

$$\text{New, S.I} = ₹ \left(\frac{800 \times 10.5 \times 3}{100} \right) = ₹ 252$$

$$\therefore \text{New amount} = 800 + 252 = 1052$$

14. (a) Let the cost of production of a table = ₹ x.

$$x \times \frac{110}{100} \times \frac{115}{100} \times \frac{125}{100} = 1265$$

$$x = \frac{1265 \times 1000000}{110 \times 115 \times 125} = ₹ 800$$

15. (c) Simple interest for Ram =

$$\frac{8000 \times 12 \times 1}{100} = 960$$

Simple interest for Mohan =

$$\frac{9100 \times 10 \times 1}{100} = 910$$

Let 'x' be the years when borrowed amount be equal.

$$8000 + 960x = 9100 + 910x$$

$$50x = 9100 - 8000$$

$$50x = 1100$$

$$x = 22 \text{ years}$$

16. (c) $8787 \div 343 \times \sqrt{50} = ?$

$$\Rightarrow 25 \times 7 = ?$$

$$\therefore ? = 175 \approx 180$$

17. (a) Required average age

$$= \left(\frac{15 \times 36 + 12 \times 16}{36 + 12} \right) \text{ years}$$

$$= \left(\frac{540 + 192}{48} \right) \text{ years} = \left(\frac{732}{48} \right) \text{ years}$$

$$= 15.25 \text{ years.}$$

18. (c) Let the radius of the base are 5k and 12k respectively

$$\therefore \frac{\text{Total surface area of the cylinder}}{\text{Total surface area of the cone}}$$

$$= \frac{2\pi r \times h + 2\pi r^2}{\pi r \sqrt{r^2 + h^2} + \pi r}$$

$$= \frac{2h+2r}{\sqrt{r^2+h^2}+r} + \frac{24k+10k}{\sqrt{25k^2+144k^2}+5k}$$

$$= \frac{34k}{13k+5k} = \frac{34k}{18k} = \frac{17}{9}$$

19. (c) Sum of roots = $2 - 15 = -13$
 Product of roots = $2 \times (-15) = -30$
 Required equation
 $= x^2 - x(\text{sum of roots}) + \text{product of roots} = 0$
 $\Rightarrow x^2 + 13x - 30 = 0$

20. (c) Roots of a quadratic equation
 $ax^2 + bx + c = 0$ are real if $b^2 - 4ac \geq 0$
 Let us work with options as follows.
 Option (a): $3x^2 + 4x + 5 = 0$
 $b^2 - 4ac = (4)^2 - 4(3)(5) = -44 < 0$.
 Thus, roots not real.
 Option (b): $x^2 + x + 4 = 0$
 $b^2 - 4ac = (1)^2 - 4(1)(4) = 1 - 16 = -15 < 0$
 Thus, root not real.
 Option (c): $(x-1)(2x-5) = 0 \Rightarrow 2x^2 - 7x + 5 = 0$
 $b^2 - 4ac = (-7)^2 - 4 \times 2 \times 5 = 49 - 40 = 9 > 0$
 thus roots are real.

or $x = 1$ and $x = \frac{5}{2}$ are real roots.

- Option (d): $2x^2 - 3x + 4 = 0$
 $b^2 - 4ac = (-3)^2 - 4(2)(4) = 9 - 32 = -23$
 Thus, roots not real.
 Hence, option (c) is correct.

21. (b) $\frac{3-5x}{x} + \frac{3-5y}{y} + \frac{3-5z}{z} = 0$
 $\Rightarrow \frac{3}{x} - \frac{5x}{x} + \frac{3}{y} - \frac{5y}{y} + \frac{3}{z} - \frac{5z}{z} = 0$
 $\Rightarrow \frac{3}{x} + \frac{3}{y} + \frac{3}{z} - 15 = 0 \Rightarrow 3\left(\frac{1}{x} + \frac{1}{y} + \frac{1}{z}\right) = 15$
 $\Rightarrow \frac{1}{x} + \frac{1}{y} + \frac{1}{z} = 5$

22. (c) $a + b + c = 2s$
 $c = 2s - a - b = (s-a) - (s-b)$
 $\therefore (s-a)^3 + (s-b)^3 + 3(s-a)(s-b)c$
 $= (s-a)^3 + (s-b)^3 + 3(s-a)(s-b)[(s-a) + (s-b)]$

(Put the value of c)
 $= [(s-a) + (s-b)]^3 = (2s-a-b)^3$
 $(a+b+c-a-b)^3 = c^3$ (Put the value of 2s)

23. (a) Since, the given lines are parallel, we have
 $\frac{1}{k} = \frac{2}{4}$
 $\therefore k = 2$

24. (d) Let d be the common difference; then 60th term
 $= 8 + 59d = 185$
 $\Rightarrow 59d = 177 \Rightarrow d = 3 \Rightarrow 31\text{st term} = 8 + 30 \times 3 = 98$.

25. (b) In ΔABC , $\angle ACB = 90^\circ$

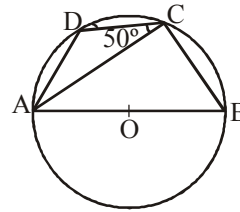

$\therefore \angle ACB + \angle ACD$
 $\Rightarrow 90^\circ + 50^\circ = 140^\circ$

As angle made by triangle in semicircle is equal to 90° .

\therefore In quad. ABCD $\angle BAD + \angle BCD = 180^\circ$
 angle of (opp. pair of quad is equal to 180°)
 $\angle BAD = 180^\circ - 140^\circ = 40^\circ$

26. (b) DE is parallel to BC
 So $\angle AED = \angle C = 35^\circ$

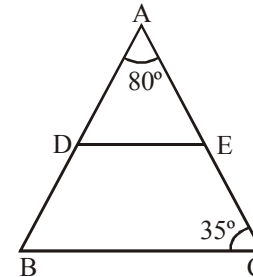

Since $\angle A = 80^\circ$
 Then $\angle ADE = 65^\circ$
 $\angle EDB$ is supplement to $\angle ADE$.
 So, $\angle EDB = 180^\circ - \angle ADE$
 $= 180^\circ - 65^\circ = 115^\circ$

27. (d)

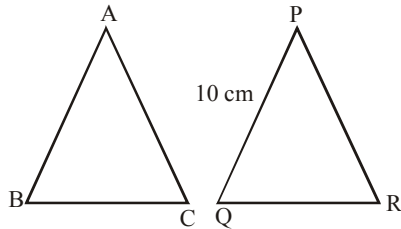

ΔABC and ΔPQR are similar.

$$\frac{AB}{PQ} = \frac{\text{Perimeter of } \Delta ABC}{\text{Perimeter of } \Delta PQR} \Rightarrow \frac{AB}{PQ} = \frac{36}{24}$$

$$\text{or } AB = \frac{36}{24} \times 10 = 15$$

28. (a) For the two similar triangles, we have

$$\frac{h_1^2}{h_2^2} = \frac{\text{Area of 1st } \Delta}{\text{Area of 2nd } \Delta} = \frac{9}{16}$$

$$\Rightarrow h_1 : h_2 = 3 : 4$$

29. (c) Let PQ and RS be two parallel chords of the circle on the opposite sides of the diameter AB and PQ = 16 cm

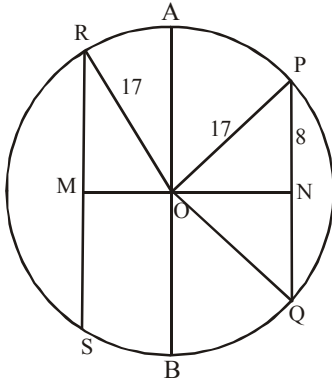

Now, $PN = 8$ (Since ON is the perpendicular bisector)

In ΔPON ,

$$ON^2 = OP^2 - PN^2$$

$$= (17)^2 - (8)^2 = 289 - 64 = 225$$

$$\text{or } ON = 15 \Rightarrow \therefore OM = 23 - 15 = 8$$

In ΔORM ,

$$RM^2 = OR^2 - OM^2$$

$$= 17^2 - 8^2 = 289 - 64 = 225$$

$$\text{or } RM = 15 \Rightarrow RS = 15 \times 2 = 30 \text{ cm}$$

30. (b) Let the required numbers be $15x$ and $11x$
Then their HCF is x . So, $x = 13$
 \therefore The numbers are (15×13) and (11×13) i.e.,
 195 and 143 31. (b) Downstream speed = $15 + 5 = 20$ km/h.
 \therefore Required distance = $20 \times \frac{24}{60} = 8$ km.32. (c) $x^2 + y^2 + z^2 = r^2 \sin^2 \theta \cos^2 \phi + r^2 \sin^2 \theta \sin^2 \phi + r^2 \cos^2 \theta$
 $= r^2 \sin^2 \theta (\cos^2 \phi + \sin^2 \phi) + r^2 \cos^2 \theta$
 $= r^2 \sin^2 \theta + r^2 \cos^2 \theta$
 $= r^2 (\sin^2 \theta + \cos^2 \theta) = r^2$ 33. (c) $\cot \theta = \frac{7}{24}$

$$\operatorname{cosec}^2 \theta = 1 + \cot^2 \theta = 1 + \frac{49}{576}$$

$$= \frac{625}{576} = \left(\frac{25}{24}\right)^2$$

$$\therefore \operatorname{cosec} \theta = \pm \frac{25}{24}$$

$$\therefore \sin \theta = \pm \frac{24}{25}$$

$$\cos^2 \theta = 1 - \sin^2 \theta = 1 - \frac{576}{625} = \frac{49}{625}$$

$$\cos \theta = \pm \frac{7}{25}$$

$$\text{as } \pi < \theta < \frac{3\pi}{2}$$

$\therefore \sin \theta$ and $\cos \theta$ both are negative.

$$\therefore \sin \theta = \frac{-24}{25}, \cos \theta = \frac{-7}{25}$$

$$\therefore \cos \theta - \sin \theta = \frac{-7}{25} + \frac{24}{25} = \frac{17}{25}$$

34. (c) $x + y = z$

$$\text{Now, } \cos^2 x + \cos^2 y + \cos^2 z$$

$$= 1 + (\cos^2 x - \sin^2 y) + \cos^2 z$$

$$= 1 + \cos(x+y) \cdot \cos(x-y) + \cos^2 z$$

$$= 1 + \cos z \cos(x-y) + \cos^2 z = 1 + \cos z [\cos(x-y) + \cos z]$$

$$= 1 + \cos z \cos[(x-y) + \cos(x+y)]$$

$$= 1 + \cos z \left[2 \cos \frac{(x-y+x+y)}{2} \cdot \cos \frac{(x-y-x-y)}{2} \right]$$

$$= 1 + 2 \cos z \cdot \cos x \cdot \cos y$$

$$= 1 + 2 \cos x \cdot \cos y \cdot \cos z$$

52. (a)
 53. (c) The only son of grandfather (paternal) of Vikas means father of Vikas. Therefore, the girl is sister of Vikas.
 54. (a) O is the husband of P. M is the son of P.

Therefore, M is the son of O.

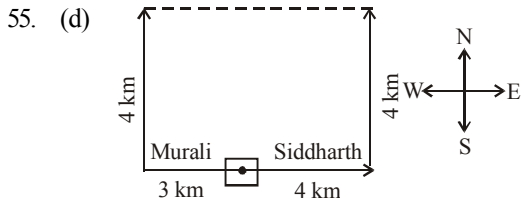

Required distance = 3 + 4 = 7 km

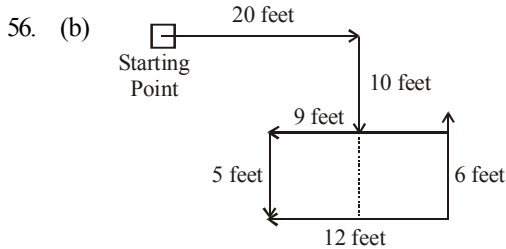

The rat is facing towards north.

57. (b) Sitting arrangement of A, B, C, D, E, F and G:

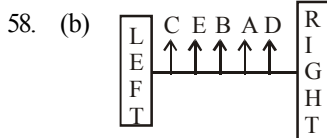
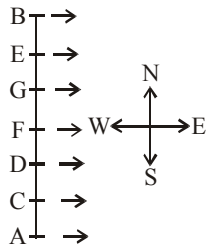

B is in the middle.

59. (c) There is no 'C' letter in the given word.
 There is no 'L' letter in the given word.
 There is no 'V' letter in the given word.

60. (c) There is no 'C' letter in the keyword.

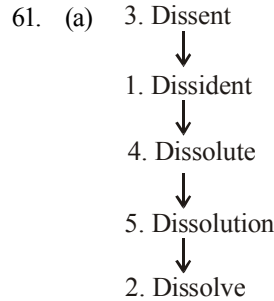

62. (c) Arrangement of words as per dictionary:

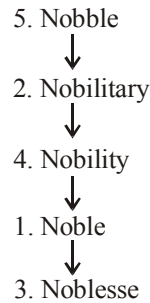

63. (d) According to Meena, 19th, 20th or 21st ... (1)
 According to her brother, 21st, 22nd or 23rd ... (2)

Combining the two, we get 21st.

64. (d) According to Nitin, Nidhi's birthday falls on Wed or Thu ... (i)
 According to Derek, Nidhi's birthday falls on Thu or Fri ... (ii)

65. (b) 5th January 1965 ⇒ Tuesday
 5th January 1966 ⇒ Wednesday
 5th January 1967 ⇒ Thursday
 5th January 1968 ⇒ Friday
 5th January 1969 ⇒ Sunday
 Since, 1968 is a Leap Year.
 5th January 1970 ⇒ Monday
 5th January 1971 ⇒ Tuesday

66. (c) At 9'O clock, the minute hand is $9 \times 5 = 45$ minute – spaces behind the hour hand.
 Therefore, the minute hand will have to gain $45 - 30 = 10$ minute space over the hour hand.
 \therefore Gain of 55 minute spaces equals 60 minutes.

∴ Gain of 15 minute spaces equals

$$= \frac{60}{55} \times 15 = \frac{180}{11} = 16 \frac{4}{11}$$

Therefore, hour and minute hands of a clock point in opposite direction after 9'O clock at $16 \frac{4}{11}$ minutes past 9.

67. (d) Sun is a star. Moon is a satellite.

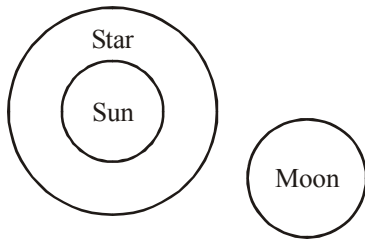

68. (c)

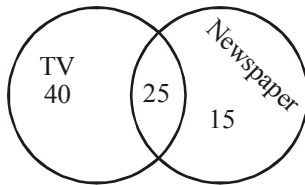

Required percentage
 $= 100 - (40 + 25 + 15) = 20\%$

69. (b) All students are girls.

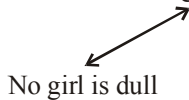

No girl is dull
 $A + E \Rightarrow E$ -type of Conclusion
 "No student is dull"
 This is Conclusion II.

All students, without exception are girls.
 Therefore, there are no boys who are students.

70. (b) First Premise is Universal Affirmative (A-type).
 Second Premise is Particular Affirmative (I-type).

Some women are teachers.



All teachers are aged.
 $I + A \Rightarrow I$ -type of Conclusion
 "Some women are aged"
 This is Conclusion II.

71. (c) $9 \times 4 + 1 \times 6 = 36 + 6 = 42$
 $8 \times 9 + 2 \times 3 = 72 + 6 = 78$

Similarly

- $6 \times 3 + 4 \times 5 = 18 + 20 = 38$
 72. (a) $30 - 6 + 5 \times 4 \div 2 = 27$
 $\Rightarrow 30 \div 6 \times 5 + 4 - 2 = 27$
 $\Rightarrow 25 + 4 - 2 = 27$
 $30 + 6 - 5 \div 4 \times 2 = 30$
 $\Rightarrow 30 \times 6 \div 5 - 4 + 2 = 30$
 $\Rightarrow 36 - 4 + 2 \neq 30$
 $30 \times 6 \div 5 - 4 + 2 = 32$
 $\Rightarrow 30 + 6 - 5 \div 4 \times 2 \neq 32$

73. (c) Suppose total number of workers in the office = x

Number of woman workers = $\frac{x}{3}$

∴ Number of man workers =

$$x - \frac{x}{3} = \frac{3x - x}{3} = \frac{2x}{3}$$

Number of married woman workers

$$= \frac{x}{3} \times \frac{1}{2} = \frac{x}{6}$$

Number of married woman workers who have children

$$= \frac{x}{6} \times \frac{1}{3} = \frac{x}{18}$$

Number of married man workers

$$= \frac{2x}{3} \times \frac{3}{4} = \frac{x}{2}$$

Number of married man workers who have children

$$= \frac{x}{2} \times \frac{2}{3} = \frac{x}{3}$$

Number of workers who have children

$$= \frac{x}{3} + \frac{x}{18}$$

$$= \frac{6x + x}{18} = \frac{7x}{18}$$

Number of workers without children

$$= x - \frac{7x}{18} = \frac{18x - 7x}{18} = \frac{11}{18}x$$

74. (b) Suppose the age of daughter is x years.

Age of brother = $x + 5$ years

Age of mother = $2x$ years

∴ $2x - 20 = x + 5$

$\Rightarrow 2x - x = 5 + 20$

$x = 25$ years
 Age of mother = $2x = 2 \times 25$
 = 50 years
 Age of father = $50 + 10$
 = 60 years
 75. (b) $T \Rightarrow 59, 66, 78, 85, 97$
 $R \Rightarrow 57, 69, 76, 88, 95$
 $I \Rightarrow 03, 10, 22, 34, 41$
 $P \Rightarrow 56, 68, 75, 87, 99$

Option	T	R	I	P
(a)	78	76	21	76
(b)	59	57	41	56
(c)	85	88	33	89
(d)	66	69	40	69

76. (a) The number 1, 3, 4, and 5 are on the adjacent faces of number 6. Therefore, 2 lies opposite 6.

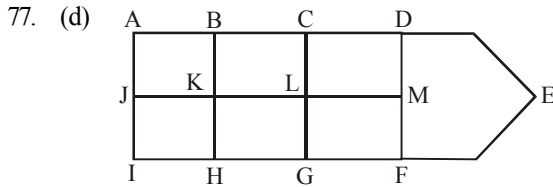

The rectangles are:
 ABKJ; JKHI; BCLK;
 KLGH; CDML; LMFG;
 ACGI; ACLJ; JLGI;
 BDFH; BDMK; KMFH;
 ADFI; ADMJ; JMFI
 ABHI; BCGH and CDFG are squares
 We know that every square is a rectangle .
 But its reverse is not always true.

78. (c)
 79. (d)
 80. (c) By interchanging fig 2 and 3 movement of the two arrows become sequential. Arrow with a dot moves anticlockwise through 90° and other arrow moves anticlockwise through 45° .
 81. (c) 82. (a) 83. (d)
 84. (b) 85. (c) 86. (a)

87. (b) 88. (a) 89. (a)
 90. (c) 91. (a) 92. (d)
 93. (b) 94. (c) 95. (a)
 96. (d) 97. (a) 98. (c)
 99. (b) 100. (b) 101. (c)
 102. (a) 103. (a) 104. (b)
 105. (d)
 106. (d) The head of the femur articulates with the acetabulum in the pelvic bone forming the hip joint, while the distal part of the femur articulates with the tibia and patella forming the knee joint. By most measures the femur is the strongest bone in the body. The femur is also the longest bone in the body.
 107. (b) Baglihar Dam, also known as Baglihar Hydroelectric Power Project, is a run-of-the-river power project on the Chenab River in the southern Doda district of the Indian state of Jammu and Kashmir. The project is estimated to cost USD \$1 billion. The first phase of the Baglihar Dam was completed in 2004. With the second phase completed on 10 October 2008, Prime Minister Manmohan Singh of India dedicated the 900-MW Baglihar hydroelectric power project to the nation.
 108. (b) The Arjuna Awards were instituted in 1961 by the government of India to recognize outstanding achievement in National sports. The award carries a cash prize of ₹ 500,000, a bronze statuette of Arjuna and a scroll.
 109. (a) 110. (b) 111. (c)
 112. (b) A dendritic drainage pattern refers to the pattern formed by the streams, rivers, and lakes in a particular drainage basin. It usually looks like the branching pattern of tree roots and it mainly develops in regions underlain by homogeneous material.
 113. (b) Deviri Express
 114. (c)
 115. (a) Pune
 116. (a) Sub1
 117. (a) Keep the Promise, Stop Pneumonia Now
 118. (b) New Delhi
 119. (c) New Delhi
 120. (c) ₹ 500 and ₹ 1000

ARITHMETIC

DIRECTIONS (Qs. 1-10): What will come in place of the question mark (?) in the following questions ?

- $3 \times ? + 30 = 0$
(a) -15 (b) 15
(c) 10 (d) -10
- $40.83 \times 1.02 \times 1.2 = ?$
(a) 49.97592 (b) 41.64660
(c) 58.7952 (d) 42.479532
- $3\frac{1}{3} + 6\frac{3}{7} \times 1\frac{1}{2} \times \frac{22}{7} = ?$
(a) 4.4 (b) $\frac{22}{7}$
(c) $\frac{5}{22}$ (d) 2.44
- $3978 + 112 \times 2 = ? \div 2$
(a) 8400 (b) 8406
(c) 8600 (d) 8404
- $(10^{3.7} \times 10^{1.3})^2 = 10^?$
(a) 6 (b) 7
(c) 5 (d) 10^{10}
- $300 + 10^2 \times 2 = ?$
(a) 450 (b) 800
(c) 550 (d) 500
- $\frac{5 \times 1.6 - 2 \times 1.4}{1.3} = ?$
(a) 4 (b) 0.4
(c) 1.4 (d) 1.2
- $3\frac{2}{5} + 7\frac{1}{5} - 5\frac{1}{4} = ?$
(a) $5\frac{3}{10}$ (b) $5\frac{3}{20}$
(c) $5\frac{7}{10}$ (d) $5\frac{7}{20}$
- $25.05 \times 123.95 + 388.999 \times 15.001 = ?$
(a) 900 (b) 8950
(c) 8935 (d) 8975
- $(15.01)^2 \times \sqrt{730} = ?$
(a) 6125 (b) 6225
(c) 6200 (d) 6075
- A boy was asked to write $2^5 \times 9^2$ but he wrote 2592. The numerical difference between the two is:
(a) 0 (b) 3
(c) 2 (d) 9
- If the two numbers are respectively 20% and 50% of a third number, what is the percentage of the first number to the second ?
(a) 10 (b) 20
(c) 30 (d) 40
- A man gains 10% by selling a certain article for a certain price. If he sells it at double the price, then the profit made is:
(a) 120% (b) 60%
(c) 100% (d) 80%
- A, B and C enter into a partnership with investments of ₹ 3500, ₹ 4500 and ₹ 5500, respectively. In the first six months, profit is ₹ 405. What is A's share in the profit ?
(a) ₹ 200 (b) ₹ 105
(c) ₹ 250 (d) ₹ 151
- A tap can fill a cistern in 8 hours and another tap can empty it in 16 hours. If both the taps are opened simultaneously, the time taken (in hours) to fill the cistern will be :
(a) 8 (b) 10
(c) 16 (d) 24
- The total number of students studying in a college is 4220. If the number of girls studying in the college is 2420, what is the respective ratio of the number of boys to the number of girls studying in the college?
(a) 90 : 131 (b) 90 : 121
(c) 121 : 70 (d) 121 : 80

17. The cost of 14 kgs. of rice is ₹ 672, the cost of 12 kgs. of wheat is ₹ 432 and the cost of 18 kgs. of sugar is ₹ 504. What is the total cost of 20 kgs. of rice, 15 kgs. of wheat and 16 kgs. of sugar?
 (a) ₹ 1,898 (b) ₹ 1,948
 (c) ₹ 2,020 (d) ₹ 1,964
18. Two years ago the ratio of the ages of Swati and Khyati was 5 : 7 respectively. Two years hence the ratio of their ages will be 7 : 9 respectively. What is the present age of Khyati?
 (a) 16 years
 (b) 14.5 years
 (c) 12 years
 (d) Cannot be determined
19. A cuboidal block of 6 cm × 9 cm × 12 cm is cut up into an exact number of equal cubes. The least possible number of cubes will be:
 (a) 6 (b) 9
 (c) 24 (d) 30
20. If the polynomial $f(x)$ is such that $f(-2) = 0$, then a factor of $f(x)$ is :
 (a) -2 (b) $2-x$
 (c) $x+2$ (d) $x-2$
21. What is the quotient, if $x^{-1} - 1$ is divided by $x - 1$?
 (a) $\frac{1}{(x-1)}$ (b) x
 (c) $\frac{-1}{(x-1)}$ (d) $\frac{-1}{x}$
22. If $x + y = 2z$ then the value of $\frac{x}{x-z} + \frac{z}{y-z}$ is
 (a) 1 (b) 3
 (c) $\frac{1}{2}$ (d) 2
23. If $x + y + z = 10$, $x^2 + y^2 + z^2 = 30$, then find the value of $x^3 + y^3 + z^3 - 3xyz$.
 (a) 50 (b) -50
 (c) 40 (d) -40
24. Find the equation of a line parallel to y-axis and passing through the point $(-3, 4)$.
 (a) $x+3=0$ (b) $x-3=0$
 (c) $x+4=0$ (d) $x-4=0$
25. If four numbers in A.P. are such that their sum is 50 and the greatest number is 4 times the least, then the numbers are—
 (a) 5, 10, 15, 20 (b) 4, 10, 16, 22
 (c) 3, 7, 11, 15 (d) None of these
26. LMNO is a trapezium with $LM \parallel NO$. If P and Q are the mid-points of LO and MN respectively and $LM = 5$ cm and $ON = 10$ cm then $PQ =$
 (a) 2.5 cm (b) 5 cm
 (c) 7.5 cm (d) 15 cm
27. X and Y are respectively two points on the sides DC and AD of the parallelogram ABCD. The area of $\triangle ABX$ is equal to
 (a) $\frac{1}{3} \times$ area of $\triangle BYC$
 (b) area of $\triangle BYC$
 (c) $\frac{1}{2} \times$ area of $\triangle BYC$
 (d) $2 \times$ area of $\triangle BYC$
28. In a triangle ABC, $\angle A = 90^\circ$ and D is the mid-point of AC. The value of $BC^2 - BD^2$ is equal to :
 (a) AD^2 (b) $2AD^2$
 (c) $3AD^2$ (d) $4AD^2$
29. If in the following figure, $PA = 8$ cm, $PD = 4$ cm, $CD = 3$ cm, then AB is equal to :
 (a) 3.0 cm (b) 3.5 cm
 (c) 4.0 cm (d) 4.5 cm
30. Find the greatest number which on dividing 1657 and 2037 leaves remainders 6 and 5 respectively.
 (a) 381 (b) 3
 (c) 127 (d) 1
31. Speed of a speed-boat when moving in the direction perpendicular to the direction of the current is 16 km/h. Speed of the current is 3 km/h. So the speed of the boat against the current will be (in km/h)
 (a) 22 (b) 9.5
 (c) 10 (d) None of these
32. The θ eliminant of $\cot \theta (1 + \sin \theta) = 4m$ and $\cot \theta (1 - \sin \theta) = 4n$ is
 (a) $(m^2 + n^2)^2 = mn$ (b) $(m^2 - n^2)^2 = mn$
 (c) $(m^2 - n^2) = m^2 n^2$ (d) $(m^2 + n^2)^2 = m^2 n^2$
33. If $p = \sin x = q$ and x is acute, then $\sqrt{p^2 - q^2} \tan x$ is equal to
 (a) p (b) q
 (c) pq (d) $p + q$
34. If $\tan \theta = \frac{3}{4}$ and $0 < \theta < 90^\circ$, then $\sin \theta \cdot \cos \theta$ is equal to
 (a) $\frac{12}{25}$ (b) $\frac{3}{5}$
 (c) $\frac{18}{25}$ (d) $\frac{4}{5}$

35. If $\sin \theta + \cos \theta = x$, then the value of $\cos^6 \theta + \sin^6 \theta$ is equal to
- (a) $\frac{1}{4}$ (b) $\frac{1}{4}(1+6x^2)$
 (c) $\frac{1}{4}(1+6x^2-3x^4)$ (d) $\frac{1}{2}(5-3x^2)$
36. If $7 \cos^2 \theta + 3 \sin^2 \theta = 4$ and $0 < \theta < \frac{\pi}{2}$, what is the value of $\tan \theta$?
- (a) $\sqrt{7}$ (b) $\frac{7}{3}$
 (c) 3 (d) $\sqrt{3}$
37. A tree 6 m tall casts a 4 m long shadow. At the same time, a flag staff casts a shadow 50 m long. How long is the flag staff?
- (a) 75m (b) 100m
 (c) 150m (d) 50m

DIRECTIONS (Qs. 38 - 40) : These questions are to be answered on the basis of the pie chart given below showing how a person's monthly salary is distributed over different expense heads.

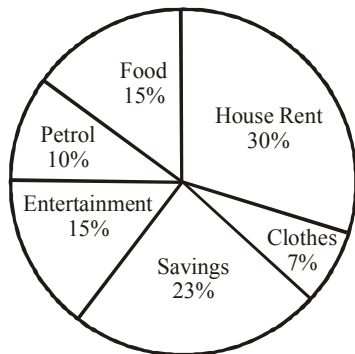

38. For a person, whose monthly salary is ₹ 6,000 p.m., how many items are there on which he has to spend more than ₹ 1,000 p.m.?
- (a) 1 (b) 2
 (c) 3 (d) 4
39. The monthly salary for a person who follows the same expense pattern, but has a petrol expense of ₹ 500 p.m., is
- (a) ₹ 2,500 (b) ₹ 3,000
 (c) ₹ 5,000 (d) ₹ 6,500
40. The percentage of money spent on clothes and savings is equal to which other single item of expense?
- (a) Petrol (b) House rent
 (c) Food (d) Entertainment

GENERAL INTELLIGENCE & REASONING

DIRECTION (Qs. 41-42): Select the related word/letter/number from the given alternatives:

41. Conference : Chairman :: Newspaper : ?
 (a) Reporter (b) Distributor
 (c) Printer (d) Editor
42. Monday : Saturday :: Thursday : ?
 (a) Sunday (b) Tuesday
 (c) Wednesday (d) Friday

DIRECTIONS (Qs. 43-44): In each of the following questions, four words have been given, out of which three are alike in some manner and the fourth one is different. Choose out the odd one.

43. (a) Fingers (b) Palm
 (c) Knee (d) Wrist
44. (a) Ear (b) Kidney
 (c) Lungs (d) Liver
45. Which one set of letters when sequentially placed at the gaps in the given letter series shall complete it?
 _ab_b_aba__abab
 (a) a bb aa (b) bb aa b
 (c) ab aa b (d) a aa ba
46. In each of the following questions, a series is given, with one term missing. Choose the correct alternative from the given ones that will complete the series.
 BMRG, DLTF, FKVE, HJXD,
 (a) JIZC (b) JZIB
 (c) GIFB (d) MOLC

DIRECTIONS (Qs. 47 - 48) : In each of the following questions select the missing number from the given responses.

47. 14, 19, 29, 49, 89, ?
 (a) 139 (b) 149
 (c) 159 (d) 169
48. 121, 144, 289, 324, 529, 576, ?
 (a) 961 (b) 841
 (c) 900 (d) 729

DIRECTIONS (Qs 49-50): In each of the following questions various terms of a series are given with one term missing as shown by (?). Choose the missing term.

49. K-11, M-13, P-16, T-20,?
 (a) V-22 (b) U-21
 (c) Y-25 (d) W-25
50. C-2, E-3, G-4, I-5,?
 (a) H-6 (b) K-6
 (c) J-8 (d) L-7
51. If in a certain code, 95789 is coded as EGKPT and 2436 is written as ALUR, then how will 24539 be written in that code
 (a) ALEUT (b) ALGTU
 (c) ALGUT (d) ALGRT
52. If $\alpha\delta\gamma\chi\varepsilon$ is decoded as ARGUE and $\sigma\phi\lambda\pi\varepsilon$ is SOLVE, what is $\pi\alpha\gamma\chi\varepsilon\lambda\omega$?
 (a) VAGUELY (b) VAGRAT
 (c) VAGUELE (d) VAGUER
53. X and Y are brothers. R is the father of Y. S is the brother of T and maternal uncle of X. What is T to R?
 (a) Mother (b) Wife
 (c) Sister (d) Brother
54. If Sudha is the daughter of the wife of the only son of the father of Priya's father, how is Sudha related to Priya. If Sudha's grandfather has no grandson?
 (a) Sister (b) Cousin
 (c) Sister-in-law (d) Mother
55. A Driver left his village and drove North for 20 kms, after which he stopped for breakfast. The he turned left and drove another 30 kms, when he stopped for lunch. After some rest, he again turned left and drove 20 kms before stopping for evening tea. Once more he turned left and drove 30 kms to reach the town where he had supper. After evening tea in which direction did he drive?
 (a) West (b) East
 (c) North (d) South
56. From her home Prerna wishes to go to school. From home she goes toward North and then turns left and then turns right, and finally she turns left and reaches school. In which direction her school is situated with respect to her home?
 (a) North-East (b) North-West
 (c) South-East (d) South-West
57. While the group photo of a family was taken, the father was found to be sitting to the left of the son and right to the grandfather. Mother was sitting to the right of her daughter but left to grandfather. Who is occupying the central place?
 (a) Son (b) Grandfather
 (c) Father (d) Mother
58. There are some flowers in a basket and at every next minute they get double. At the 30th minute the basket becomes full. Then at exactly which minute the basket is half filled?
 (a) 15 minutes (b) 20 minutes
 (c) 29 minutes (d) 12 minutes
59. From the given alternative words, select the word which **cannot** be formed using the letters of the given word:
 'DETERMINATION'
 (a) DETENTION (b) DESTINATION
 (c) TERMINATE (d) DOMINATE
60. Some letters are given with numbers from 1 to 7. Select the sequence number which arranges the letters into a meaningful word.
 S O U B R C E
 1 2 3 4 5 6 7
 (a) 4216573 (b) 2416537
 (c) 2146357 (d) 2416357
61. Arrange the following words in a logical order.
 1. Birth 2. Death
 3. Childhood 4. Infancy
 5. Adolescence 6. Adulthood
 6. Old age
 (a) 2, 6, 7, 5, 4, 3, 1 (b) 1, 4, 3, 5, 6, 7, 2
 (c) 1, 4, 3, 6, 5, 7, 2 (d) 2, 7, 6, 4, 5, 3, 1
-
- DIRECTIONS (62) :** In each of the following question, which one of the given responses would be a meaningful order of the following words in ascending order?
-
62. 1. Mother 2. Infant
 3. Milk 4. Crying
 5. Smiling
 (a) 1, 5, 2, 4, 3 (b) 2, 4, 1, 3, 5
 (c) 2, 5, 1, 3, 4 (d) 3, 2, 1, 5, 4
63. Smita correctly remembers that last year Diwali was celebrated before November but after May. Sanjay correctly remembers that last year he had Diwali holidays after July. Mohan correctly remembers that the month in which Diwali was celebrated had only 30 days. In which month of the year was Diwali definitely celebrated?
 (a) July (b) August
 (c) September (d) October

64. Pratap correctly remembers that his mother's birthday is before twenty-third April but after nineteenth April, whereas his sister correctly remembers that their mother's birthday is not on or after twenty-second April. On which day in April is definitely their mother's birthday?

- (a) Twentieth
- (b) Twenty-first
- (c) Twentieth or Twenty-first
- (d) Cannot be determined

65. Suresh was born on 4th October 1999. Shashikanth was born 6 days before Suresh. The Independence Day of that year fell on Sunday. Which day was Shashikanth born?

- (a) Tuesday
- (b) Wednesday
- (c) Monday
- (d) Sunday

66. At what time are the hands of clocks together between 6 and 7?

- (a) $32\frac{8}{11}$ minutes past 6
- (b) $34\frac{8}{11}$ minutes past 6
- (c) $30\frac{8}{11}$ minutes past 6
- (d) $32\frac{5}{7}$ minutes past 6

67. Which diagram correctly represents the relationship between Human beings, Teachers, Graduates?

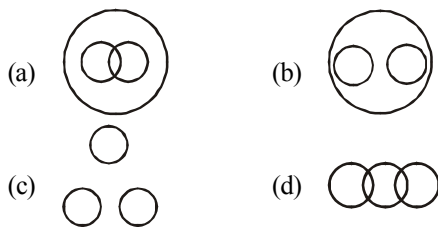

68. Which one of the following Venn diagram represents the best relationship between Snake, Lizard, Reptiles?

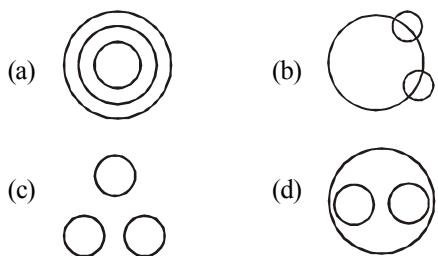

DIRECTIONS (69-70): In each of the following question, one, two or more statements are given followed by conclusion I, II or more. You have to consider the statements to be true, even if they seem to be at variance from commonly known facts. You are to decide which of the given conclusions definitely follows from the given statements.

69. **Statements:**

- 1. All skaters are good swimmers.
- 2. All good swimmers are runners.

Conclusions:

- I. Some runners are skaters.
- II. Some skaters are good swimmers.
- (a) Only conclusion I follows.
- (b) Only conclusion II follows.
- (c) Both conclusions I and II follow.
- (d) Neither conclusion I nor II follows.

70. **Statements:**

- 1. All lawyers are liars.
- 2. Some women are lawyers.

Conclusions:

- I. Some women are liars.
- II. All liars are women.
- (a) Neither conclusion I nor II follows.
- (b) Both conclusions I and II follow.
- (c) Only conclusion I follow.
- (d) Only conclusion II follows.

71. Some equations given below have been solved on the basis of a certain system. Find the correct answer for the unsolved equation on that basis. If $9 * 7 = 32$, $13 * 7 = 120$, $17 * 9 = 208$, then $19 * 11 = ?$

- (a) 150
- (b) 180
- (c) 210
- (d) 240

72. If '×' means 'addition', '-' means 'division', '+' means 'subtraction' and '÷' means 'multiplication', then which of the following equations is correct?

- (a) $16 + 5 - 10 \times 4 \div 3 = 9$
- (b) $16 - 5 \times 10 \div 4 + 3 = 12$
- (c) $16 + 5 \div 10 \times 4 - 3 = 9$
- (d) $16 \times 5 \div 10 \div 4 - 3 = 19$

73. Mr. and Mrs. Gopal have 3 daughters and each daughter has one brother. How many persons are there in the family?

- (a) 5
- (b) 6
- (c) 7
- (d) 8

74. There are three baskets of fruits. First basket has twice the number of fruits in the 2nd basket.

Third basket has $\frac{3}{4}$ th of the fruits in the first.

The average of the fruits in all the baskets is 30. What is the number of fruits in the first basket?

- (a) 20
- (b) 30
- (c) 35
- (d) 40

Direction (Qs. 75) A word is represented by only one set of numbers as given in any one of the alternatives. The sets of numbers given in the alternatives are represented by two classes of alphabets as shown in two matrices given below. The columns and rows of Matrix I are numbered from 0 to 4 and that of Matrix II are numbered from 5 to 9. A letter from these matrices can be represented first by its row and next by its column, e.g.

75. 'F' can be represented by 14, 21, etc. 'T' can be represented by 59, 78, etc. Similarly, identify the word POSE.

MATRIX - I

	0	1	2	3	4
0	D	E	F	I	N
1	I	N	D	E	F
2	E	F	I	N	D
3	N	D	E	F	I
4	F	I	N	D	E

MATRIX - II

	5	6	7	8	9
5	O	P	R	S	T
6	S	T	O	P	R
7	P	R	S	T	O
8	T	O	P	R	S
9	R	S	T	O	P

- (a) 87, 55, 89, 43
- (b) 68, 98, 58, 21
- (c) 75, 86, 67, 14
- (d) 56, 67, 77, 01

76. From the given blocks when 10 is at the bottom, which number will be at the top?

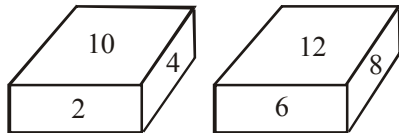

- (a) 8
- (b) 12
- (c) 6
- (d) 4

77. How many triangles are there in the given figure?

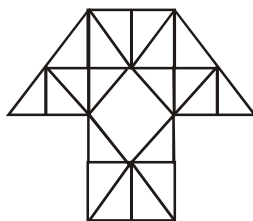

- (a) 29
- (b) 38
- (c) 40
- (d) 35

78. Identify the answer figure from which the pieces given in question figure have been cut.

Question Figure:



Answer Figure:

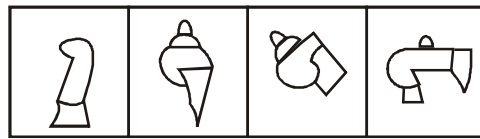

- (a)
- (b)
- (c)
- (d)

DIRECTION (Q. 79) : In the following questions, a square sheet of paper is folded along the dotted lines and then cuts are made on it. How would the sheet look when opened? Select the correct figure from the given choices.

79.

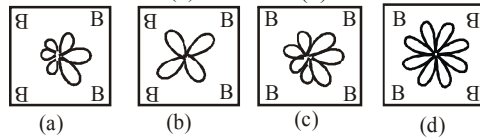
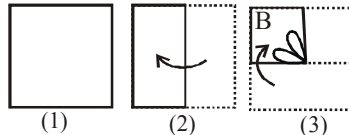

DIRECTIONS (Q. 80) : In each of the following questions there are given five figures. If two of these figures are interchanged in a question, the five figures are arranged in a certain order. You have to select from the four given alternatives the correct answer for each question.

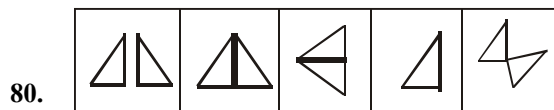

- (a) 2,3
- (b) 3,4
- (c) 4,5
- (d) 1,5

GENERAL AWARENESS

81. OCR stands for
- Optical Character Recognition
 - Optical CPU Recognition
 - Optimal Character Rendering
 - Other Character Restoration
82. If a new device is attached to a computer, such as a printer or scanner, its..... must be installed before the device can be used.
- buffer
 - driver
 - pager
 - server
83. The software that allows users to surf the Internet is called a/an
- Search engine
 - Internet Service Provider (ISP)
 - Multimedia application
 - Browser
84. A tuple is a
- column of a table
 - two dimensional table
 - row of a table
 - None of these
85. The method of file organization in which data records in a file are arranged in a specified order according to a key field is known as the
- Direct access method
 - Queuing method
 - Predetermined method
 - Sequential access method
86. Which one of the following is not a function of Election Commission?
- Allotment of symbols
 - Fixation of election dates
 - Maintaining fairness of election
 - Selecting the candidates for election
87. Who was the first recipient of the "Bharat Ratna" Award posthumously?
- K. Kamaraj
 - Lal Bahadur Shastri
 - M.G Ramachandran
 - B.R. Ambedkar
88. If there is a deadlock between Rajya Sabha and Lok Sabha over an ordinary bill, it will be resolved by
- The President
 - The Council of Ministers
 - The Joint Session of Parliament
 - The Supreme Court
89. According to Ferrel's law (Coriolis Force) winds change their direction
- Towards left in Northern hemisphere and towards right in Southern hemisphere.
 - Towards right in Northern hemisphere and towards left in Southern hemisphere.
 - Towards right in both the hemisphere.
 - Towards left in both the hemisphere.
90. Which one of the following is wrongly paired?
- | Country | Currency |
|----------------|----------|
| (a) Japan | Yen |
| (b) Iran | Rand |
| (c) Bangladesh | Taka |
| (d) Bhutan | Ngultrum |
91. The national income of a nation is the
- Government's annual revenue
 - Sum total of factor incomes
 - Surplus of public sector enterprises
 - Exports minus imports
92. The Constitutional Amendment Act that has introduced safeguards against the misuse of proclamation of national emergency is the
- 42nd Amendment Act
 - 43rd Amendment Act
 - 44th Amendment Act
 - 45th Amendment Act
93. A Retired Judge of a High Court is not permitted to practice as a lawyer in
- Supreme Court
 - Any Court in India
 - High Courts
 - Except the High Court where he retired
94. Who among the following can dismiss Governor of a state from his office?
- State legislative assembly
 - Parliament
 - President
 - None of them
95. Prithvi Raj Chauhan was defeated in the Second Battle of Tarain by
- Mahmud Ghazni
 - Muhammad Ghori
 - Qutbuddin Aibak
 - Yalduz
96. Who among the following first propounded the idea of Basic Education?
- Jawahar Lal Nehru
 - Raja Ram Mohan Roy
 - Mahatma Gandhi
 - Dayanand Saraswati

97. Arrange the following in chronological order:
 I. Dandi March
 II. Simon Commission
 III. Poona Pact
 IV. Gandhi Irwin Pact
 (a) II, I, III, IV (b) II, I, IV, III
 (c) IV, III, I, II (d) IV, III, II, I
98. Which one of the following is not correctly matched?
 (a) Darjeeling - West Bengal
 (b) Mount Abu - Rajasthan
 (c) Kodaikanal - Tamil Nadu
 (d) Simla - Uttar Pradesh
99. Radiocarbon is produced in the atmosphere as a result of
 (a) collision between fast neutrons and nitrogen nuclei present in the atmosphere
 (b) action of ultraviolet light from the sun on atmospheric oxygen
 (c) action of solar radiations particularly cosmic rays on carbon dioxide present in the atmosphere
 (d) lightning discharge in atmosphere
100. It is easier to roll a stone up a sloping road than to lift it vertical upwards because
 (a) work done in rolling is more than in lifting
 (b) work done in lifting the stone is equal to rolling it
 (c) work done in both is same but the rate of doing work is less in rolling
 (d) work done in rolling a stone is less than in lifting it
101. The absorption of ink by blotting paper involves
 (a) viscosity of ink
 (b) capillary action phenomenon
 (c) diffusion of ink through the blotting
 (d) siphon action
102. Siphon will fail to work if
 (a) the densities of the liquid in the two vessels are equal
 (b) the level of the liquid in the two vessels are at the same height
 (c) both its limbs are of unequal length
 (d) the temperature of the liquids in the two vessels are the same
103. Large transformers, when used for some time, become very hot and are cooled by circulating oil. The heating of the transformer is due to
 (a) the heating effect of current alone
 (b) hysteresis loss alone
 (c) both the heating effect of current and hysteresis loss
 (d) intense sunlight at noon
104. Nuclear sizes are expressed in a unit named
 (a) Fermi (b) angstrom
 (c) Newton (d) tesla
105. Light year is a unit of
 (a) Time (b) distance
 (c) Light (d) intensity of light
106. Mirage is due to
 (a) unequal heating of different parts of the atmosphere
 (b) magnetic disturbances in the atmosphere
 (c) depletion of ozone layer in the atmosphere
 (d) equal heating of different parts of the atmosphere
107. Light from the Sun reaches us in nearly
 (a) 2 minutes (b) 4 minutes
 (c) 8 minutes (d) 16 minutes
108. Stars appears to move from east to west because
 (a) all stars move from east to west
 (b) the earth rotates from west to east
 (c) the earth rotates from east to west
 (d) the background of the stars moves from west to east
109. The Dandi March of Gandhi-is an example of
 (a) Non-Coopefation
 (b) Direct Action
 (c) Boycott
 (d) Civil Disobedience
110. Presidential form of government consists of the following :
 (a) Popular election of the President
 (b) No overlap in membership between the executive and the legislature
 (c) Fixed term of office
 (d) All the above
111. Which one of the following inscriptions relate to the Chalukya king, Pulakesin II?
 (a) Nasik (b) Maski
 (c) Hathigumpha (d) Aihole
112. Match correctly the following, deserts and their location by choosing the correct response:
- | <i>Desert</i> | <i>Location</i> |
|---------------|------------------|
| a. Kalahari | 1. South America |
| b. Atacama | 2. Australia |

Hints & Explanations

1. (d) $3 \times ? + 30 = 0$
 $\Rightarrow ? = \frac{-30}{3} = -10$
2. (a) $? = 40.83 \times 1.02 \times 1.2 = 49.97592$
3. (d) $? = 3\frac{1}{3} + 6\frac{3}{7} \times 1\frac{1}{2} \times \frac{22}{7}$
 $= \frac{10}{3} + \frac{45}{7} \times \frac{3}{2} \times \frac{22}{7} = 2.44$
4. (d) $3978 + 112 \times 2 = ? \div 2$
 $\therefore ? = (3978 + 224) \times 2 = 8404$
5. (d) $(10^{3.7} \times 10^{1.3})^2 = 10^?$
 $\Rightarrow (10^{3.7+1.3})^2 = 10^? \quad [\because a^b \times a^c = a^{b+c}]$
 $\therefore 10^? = (10^5)^2$
 $= 10^{5 \times 2} \quad [\because (a^b)^c = a^{bc}] = 10^{10}$
6. (d) $? = 300 + (100 \times 2) = 300 + 200 = 500$
7. (a) $? = \frac{5 \times 1.6 - 2 \times 1.4}{1.3} = \frac{8 - 2.8}{1.3} = \frac{5.2}{1.3} = 4$
8. (d) $3\frac{2}{5} + 7\frac{1}{5} - 5\frac{1}{4} = (3 + 7 - 5) + \left(\frac{2}{5} + \frac{1}{5} - \frac{1}{4}\right)$
 $= 5 + \left(\frac{8+4-5}{20}\right) = 5\frac{7}{20}$
9. (c) $25 \times 124 + 389 \times 15 = 3100 + 5835 = 8935$
10. (d) $(15)^2 \times \sqrt{730} = 225 \times 27 = 6075$
11. (a) $2^5 \times 9^2 = 32 \times 81 = 2592$
 $\therefore \text{Difference} = 2^5 \times 9^2 - 2592$
 $= 2592 - 2592 = 0$
Hence, the numerical difference is 0.
12. (d) Let the third number be 100. Then, the first and second numbers will be 20 and 50, respectively.
Required % = $\frac{20}{50} \times 100 = 40$
13. (a) Let the cost price of an article be ₹ 100
then, S.P. = $100 + 10 = ₹ 110$
If S.P. = $2 \times 110 = ₹ 220$
then, profit % = $\frac{(220-100)}{100} \times 100 = 120\%$
14. (b) Ratio of investment
= $3500 : 4500 : 5500 = 35 : 45 : 55 = 7 : 9 : 11$
Since, Ratio of investment is same as ratio of profit.
 \therefore Ratio of profit = $7 : 9 : 11$
Now, profit = ₹ 405
 \therefore A's share = $\frac{7}{27} \times 405 = ₹ 105$
15. (c) Part of the tank filled in one hour =
 $\frac{1}{8} - \frac{1}{16} = \frac{1}{16}$
Hence, the tank will be filled in 16 hours.
16. (b) Required ratio
= $(4220 - 2420) : 2420$
= $1800 : 2420 = 90 : 121$
17. (b) C.P. of 20 kg of rice
= ₹ $\left(\frac{672}{14} \times 20\right)$
= ₹ 960
C.P. of 15 kg of wheat
= ₹ $\left(\frac{432}{12} \times 15\right) = ₹ 540$
C.P. of 16 kg of sugar
= ₹ $\left(\frac{504}{18} \times 16\right) = ₹ 448$
 \therefore Total cost price
= ₹ $(960 + 540 + 448) = ₹ 1948$
18. (a) Let the ages of Swati and Khyati two years ago be $5x$ and $7x$ years respectively.
According to the question,
 $\frac{5x+4}{7x+4} = \frac{7}{9}$
 $\Rightarrow 49x + 28 = 45x + 36$
 $\Rightarrow 4x = 8 \Rightarrow x = 2$
 \therefore Khyati's present age = $7x + 2 = 7 \times 2 + 2$
= 16 years

19. (c) Volume of block = $(6 \times 9 \times 12) \text{ cm}^3 = 648 \text{ cm}^3$.
Side of largest cube = H.C.F. of 6 cm, 9 cm, 12 cm = 3 cm.
Volume of the cube = $(3 \times 3 \times 3) = 27 \text{ cm}^3$.

$$\therefore \text{Number of cubes} = \left(\frac{648}{27} \right) = 24.$$

20. (c) Since $f(-2) = 0$
So, by factor theorem $(x + 2)$ is a factor of the polynomial $f(x)$.

21. (d)
$$\frac{x^{-1} - 1}{x - 1} = \frac{\frac{1}{x} - 1}{x - 1} = \frac{1 - x}{x(x - 1)} = -\frac{1}{x}$$

22. (a) $x + y = 2z \Rightarrow x = 2z - y$
Subtract 'z' from both sides
 $\Rightarrow x - z = 2z - y - z = z - y$

$$\therefore \frac{x}{x - z} + \frac{z}{y - z}$$

$$= \frac{x}{x - z} - \frac{z}{z - y}$$

$$= \frac{x}{x - z} - \frac{z}{x - z} = \frac{x - z}{x - z} = 1$$

23. (b) $\therefore x^3 + y^3 + z^3 - 3xyz = (x + y + z)(x^2 + y^2 + z^2 - xy - yz - zx)$ (Formula)

We do not know the value of $xy + yz + zx$.
First find it.

$$\therefore (x + y + z)^2 = x^2 + y^2 + z^2 + 2(xy + yz + zx)$$
 (Formula)

$$(10)^2 = 30 + 2(xy + yz + zx)$$

$$\Rightarrow 2(xy + yz + zx) = 100 - 30 = 70$$

$$\therefore xy + yz + zx = \frac{70}{2} = 35$$

$$\begin{aligned} \therefore x^3 + y^3 + z^3 - 3xyz &= (x + y + z)(x^2 + y^2 + z^2 - xy - yz - zx) \\ &= 10(30 - 35) = -50 \end{aligned}$$

24. (a) Required equation of the line is

$$\frac{y - 4}{x + 3} = \tan 90^\circ = \infty$$

$$\Rightarrow \frac{y - 4}{x + 3} = \frac{1}{0} \Rightarrow x + 3 = 0$$

25. (a) 26. (c) 27. (b)

28. (c) We have, $AD = \frac{1}{2} AC$

(since D is the midpoint of side AC)

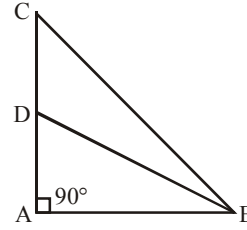

In a $\triangle ABC$ and $\triangle ABD$, $BC^2 = AB^2 + AC^2$
and $BD^2 = AB^2 + AD^2$

$$\begin{aligned} \text{Therefore, } BC^2 - BD^2 &= AB^2 + AC^2 - AB^2 - AD^2 = AC^2 - AD^2 \\ &= (AC - AD)(AC + AD) = (2AD - AD)(2AD + AD) \\ &= AD \times 3AD = 3AD^2 \end{aligned}$$

29. (d) We know that
 $PC \times PD = PA \times PB$

$$\Rightarrow PB = \frac{28}{3} = 3.5 \text{ cm}$$

Therefore, $AB = AP - BP = 8 - 3.5 = 4.5 \text{ cm}$
Required number = H.C.F. of $(1657 - 6)$ and $(2037 - 5)$ = H.C.F. of 1651 and 2032

30. (c)

$$\begin{array}{r} 1651 \overline{)2032} \quad (1 \\ \underline{1651} \\ 381 \overline{)1651} \quad (4 \\ \underline{1524} \\ 127 \overline{)381} \quad (3 \\ \underline{381} \\ \times \end{array}$$

\therefore Required number = 127.

31. (d)

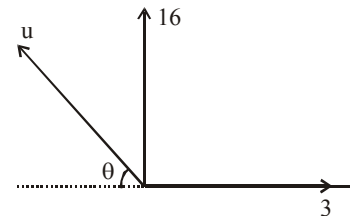

Let the speed of the boat be u km per hour.

$$\therefore u \cos \theta = 3, u \sin \theta = 16$$

$$\Rightarrow \tan \theta = \frac{16}{3} \Rightarrow \sin \theta = \frac{16}{\sqrt{265}}$$

Since, $u \sin \theta = 16$

$$\Rightarrow u \cdot \frac{16}{\sqrt{265}} = 16 \Rightarrow u = \sqrt{265} = 16.28 \text{ km}$$

per hour

\therefore Speed of the boat against the current
 $= u - 3 = 16.28 - 3 = 13.28 \text{ km per hour.}$

32. (b) Put $\theta = 45^\circ$

$$4m = 1 \left(1 - \frac{1}{\sqrt{2}} \right) \frac{\sqrt{2}}{\sqrt{2}} \quad \dots(1)$$

$$\text{and } 4n = 1 \left(1 - \frac{1}{\sqrt{2}} \right) \frac{\sqrt{2}-1}{\sqrt{2}} \quad \dots(2)$$

Squaring Eqn. (1) and (2) on both sides and subtract (2) from (1)

$$\begin{aligned} (4m)^2 - (4n)^2 &= \left(\frac{\sqrt{2}+1}{\sqrt{2}} \right)^2 - \left(\frac{\sqrt{2}-1}{\sqrt{2}} \right)^2 \\ &= \frac{1}{2} [4 \times \sqrt{2} \times 1] \quad 2\sqrt{2} \end{aligned}$$

$$\Rightarrow m^2 - n^2 = \frac{1}{4\sqrt{2}} \Rightarrow (m^2 - n^2)^2 = \frac{1}{32} \dots(i)$$

$$16mn = \frac{\sqrt{2}+1}{\sqrt{2}} \times \frac{\sqrt{2}-1}{\sqrt{2}} = \frac{1}{2} \text{ or } mn = \frac{1}{32} \dots(ii)$$

$$(m^2 - n^2)^2 = mn$$

33. (b) $\sin x = \frac{q}{p}$

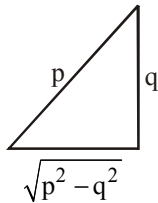

$$\therefore \tan x = \frac{q}{\sqrt{p^2 - q^2}}$$

$$\therefore \sqrt{p^2 - q^2} \tan x = q$$

34. (a) $\tan \theta = \frac{3}{4} \Rightarrow \sin \theta = \frac{3}{5}$ and $\cos \theta = \frac{4}{5} \Rightarrow$

$$\sin \theta \cos \theta = \frac{12}{25}$$

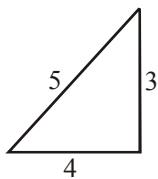

35. (c) $\sin \theta + \cos \theta = x$

On squaring both sides, we get

$$\sin^2 \theta + \cos^2 \theta + 2 \sin \theta \cos \theta = x^2$$

$$1 + 2 \sin \theta \cos \theta = x^2$$

$$1 + 2 \sin \theta \cos \theta = x^2$$

$$\therefore \sin \theta \cos \theta = \frac{x^2 - 1}{2}$$

$$\cos^6 \theta + \sin^6 \theta = (\cos^2 \theta)^3 + (\sin^2 \theta)^3 =$$

$$(\cos^2 \theta + \sin^2 \theta)$$

$$(\cos^4 \theta - \cos^2 \theta \sin^2 \theta + \sin^4 \theta)$$

$$= [(\cos^2 \theta)^2 + (\sin^2 \theta)^2 - \cos^2 \theta \sin^2 \theta]$$

$$= [(\cos^2 + \sin^2)^2 - 2 \cos^2 \theta \sin^2 \theta - \cos^2 \theta \sin^2 \theta]$$

$$= 1 - 3 \cos^2 \theta \sin^2 \theta = 1 - 3 \left(\frac{x^2 - 1}{2} \right)^2$$

$$= 1 - \frac{3(x^4 - 2x^2 + 1)}{4} = \frac{4 - 3x^4 + 6x^2 - 3}{4}$$

$$= \frac{1 - 3x^4 + 6x^2}{4} = \frac{1}{4} (1 - 3x^4 + 6x^2)$$

$$= \frac{1 - 3x^4 + 6x^2}{4} = \frac{1}{4} (1 - 3x^4 + 6x^2)$$

36. (d) $7 \cos^2 \theta + 3 \sin^2 \theta = 4$

On dividing by $\cos^2 \theta$ at both sides, we get

$$\frac{7 \cos^2 \theta}{\cos^2 \theta} + \frac{3 \sin^2 \theta}{\cos^2 \theta} = \frac{4}{\cos^2 \theta}$$

$$7 + 3 \tan^2 \theta = 4 \sec^2 \theta$$

$$7 + 3 \tan^2 \theta = 4(1 + \tan^2 \theta)$$

$$7 + 3 \tan^2 \theta = 4 + 4 \tan^2 \theta$$

$$3 = \tan^2 \theta \Rightarrow \tan \theta = \sqrt{3}$$

37. (a) Let h be the height. Then, $6 : 4 = h : 50$

$$\Rightarrow h = \frac{50 \times 6}{4} = 75 \text{ m}$$

38. (b) On two items, savings and house rent, he has to invest more than ₹ 1000.

39. (c) $10\% = 500 \Rightarrow 100\% = ₹ 5000$

40. (b) Money spent on clothes + Savings = Money spent on house rent.

41. (d) Chairman is the highest authority in a conference. Similarly, editor is the highest authority in a newspaper agency.

42. (b) Second is five days ahead of the first.

43. (c) : All except Knee are parts of hand.

44. (a) : All except Ear are internal organs.

45. (d) $\boxed{a} a b \boxed{a} b / \boxed{a} a b a$
 $\boxed{b} / \boxed{a} a b a b$

46. (a)
 47. (d) 48. (b)
 49. (c)

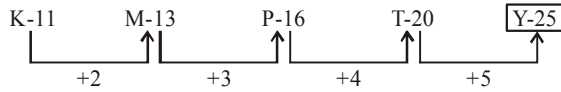

50. (b)

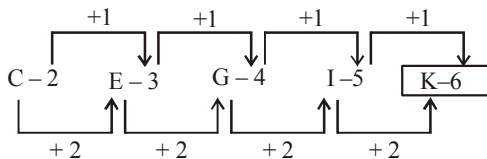

51. (c) $9 \ 5 \ 7 \ 8 \ 9$
 $\downarrow \downarrow \downarrow \downarrow \downarrow$
 E G K P T
 A L U R
 $\downarrow \downarrow \downarrow \downarrow$
 2 4 3 6
 Therefore,
 $2 \ 4 \ 5 \ 3 \ 9$
 $\downarrow \downarrow \downarrow \downarrow \downarrow$
 A L G U T

52. (a) $\alpha \ \delta \ \gamma \ \chi \ \varepsilon$
 $\downarrow \downarrow \downarrow \downarrow \downarrow$
 A R G U E
 $\sigma \ \phi \ \lambda \ \pi \ \varepsilon$
 $\downarrow \downarrow \downarrow \downarrow \downarrow$
 S O L V E

Therefore,
 $\pi \ \infty \ \gamma \ \chi \ \varepsilon \ \lambda \ \omega$
 $\downarrow \downarrow \downarrow \downarrow \downarrow \downarrow \downarrow$
 V A G U E L Y
 ω may be the code for Y.

53. (b) R is father of X and Y.
 S is maternal uncle of X and Y.
 Considering the given options, it may be assumed that T is wife of R.

54. (a) Father of Priya's father means grandfather of Priya. Sudha is the daughter of the wife of Priya's grandfather's only son, i.e., father of Priya.
 Therefore, Sudha is sister of Priya.

55. (b)

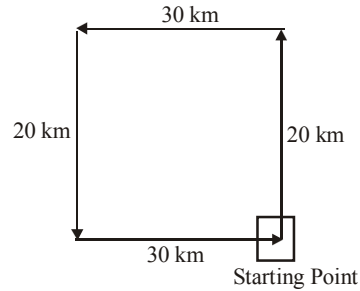

56. (b)

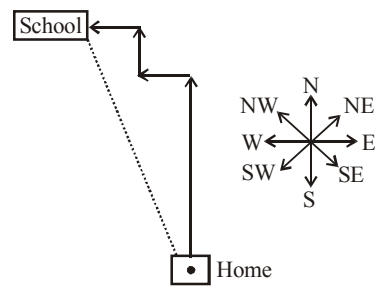

It is clear from the diagram that school is in North-West direction with respect to home.

57. (b) Father = F, Son = S, Grandfather = GF, Mother = M, Daughter = D

$\boxed{\text{LEFT}} \ \boxed{\text{D}} \ \boxed{\text{M}} \ \boxed{\text{GF}} \ \boxed{\text{F}} \ \boxed{\text{S}} \ \boxed{\text{RIGHT}}$

58. (c) At every next minute flowers in the basket get doubled.

Therefore, it was half filled in 29th minute.

59. (b) There is no 'S' letter in the keyword.

O B S C U R E
 $\downarrow \downarrow \downarrow \downarrow \downarrow \downarrow$
 2 4 1 6 3 5 7

60. (d) Meaningful order

1. Birth
- ↓
4. Infancy
- ↓
3. Childhood
- ↓
5. Adolescence
- ↓
6. Adulthood
- ↓
7. Old age
- ↓
2. Death

62. (b) Meaningful order to words in ascending order:

2. Infant
 ↓
 4. Crying
 ↓
 1. Mother
 ↓
 3. Milk
 ↓
 5. Smiling

63. (c) As per Sunita, Jun, Jul, Aug, Sep, Oct...(i)
 As per Sanjay, Aug, Sep, Oct, Nov, Dec ...
 ...
 ...
 As per Mohan, Apr, Jun, Sep, Nov ...
 From (i), (ii) and (iii), Diwali was celebrated in Sep.

64. (c) According to Pratap his mother's birthday may be on 20th, 21st or 22nd April
 According to Pratap's sister their mother's birthday may be from 1st April to 21st April.
 Common Dates ⇒ 20th and 21st

65. (b) Shashikant was born on 29th September 1999.
 15th August, 1999 was Sunday.
 Days upto 29th September from 15 August.
 $16 + 29 = 45$ days = 6 weeks 3 old days.
 Sunday + 3 = Wednesday.

66. (a) Hands of clock will be together at $32\frac{8}{11}$ minutes past 6.
 There are 30 minute spaces between hour and minute hand at 6 O' clock.
 The minute hand gains 55 minutes in 60 minutes.
 ∴ It will gain 30 minutes in

$$\frac{60}{55} \times 33 = 32\frac{8}{11} \text{ minutes}$$

67. (a) Some teachers may be graduates and vice-versa.
 All teachers and all graduates are human beings.

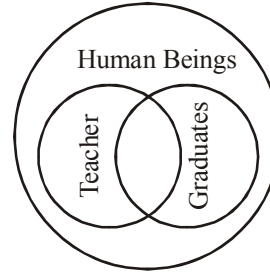

68. (d) Snake is different from Lizard, but both are reptiles.

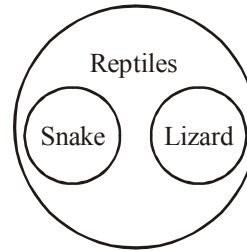

69. (c) Both the Premises are Universal Affirmative (A-type).

All skaters are good swimmers.

All good swimmers are runners.

A + A ⇒ A-type of Conclusion

“All skaters are runners.”

Conclusion I is Converse of it.

Conclusion II is Implication of the first Premise.

70. (c) First Premise is Universal Affirmative (A-type).

Second Premise is Particular Affirmative (I-type).

Some womens are lawyers

All lawyers are liars.

I + A ⇒ I-type of Conclusion

“Some womens are liars”.

This is Conclusion I.

71. (d) $9 + 7 = 16$; $9 - 7 = 2$

$$16 \times 2 = 32$$

$$13 + 7 = 20; 13 - 7 = 6$$

$$20 \times 6 = 120$$

$$17 + 9 = 26;$$

$$26 \times 8 = 208$$

$$19 + 11 = 30; 19 - 11 = 8$$

$$30 \times 8 = 240$$

72. (a) $16 + 5 - 10 \times 4 \div 3 = 9$
 $\Rightarrow 16 \times 5 \div 10 + 4 - 3 = 9$
 $\Rightarrow 8 + 4 - 3 = 9$
 $16 - 5 \times 10 \div 4 + 3 = 12$
 $\Rightarrow 16 \div 5 + 10 - 4 \times 3 = 12$
 $\Rightarrow \frac{16}{5} + 10 - 12 \neq 12$

73. (d) Total number of persons in the family
 $= 2 + 3 + 3 = 8$

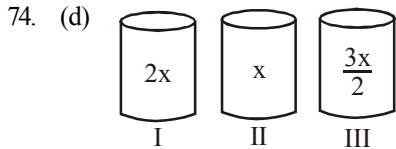

Suppose the number of fruits in the second basket = x
 Number of fruits in the first basket = 2x
 Number of fruits in the third basket =

$$2x \times \frac{3}{4} = \frac{3x}{2}$$

Now, $2x \times x + \frac{3}{4} = 30 \times 3$
 $= \frac{4x + 2x + 3x}{2} = 30 \times 3$
 $= 9x = 30 \times 3 \times 2$
 $\therefore x = \frac{30 \times 3 \times 2}{9} = 20$

$2x = 2 \times 20 = 40$

75. (b) P \Rightarrow 56, 8, 75, 87, 99
 O \Rightarrow 55, 67, 79, 86, 98
 S \Rightarrow 58, 65, 77, 89, 96
 E \Rightarrow 01, 13, 20, 32, 44

Option	P	O	S	E
(a)	87	55	89	43
(b)	68	98	58	21
(c)	75	86	67	14
(d)	56	67	77	01

76. (b) From the two views of blocks it is clear that when 10 is at the bottom, number 12 will be at the top.

77. (c)

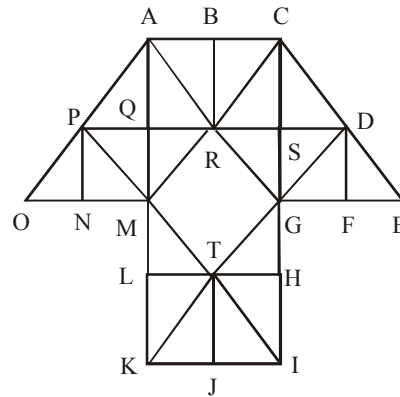

The simplest triangles are:

- Δ PNO; Δ PNM; Δ MPQ;
- Δ MQR; Δ AQP; Δ AQR;
- Δ BRA; Δ BRC; Δ SRC;
- Δ SCD; Δ SGR; Δ SGD;
- Δ DFG; Δ DFE; Δ TLM;
- Δ TJK; Δ TLK; Δ TIH;

The triangles composed of two components are:

- Δ PON; Δ PMA; Δ APR;
- Δ RAM; Δ RAC; Δ ARGC;
- Δ DGC; Δ DGE; Δ MPR;
- Δ GRD; Δ DGE; Δ TMK;
- Δ TKI; Δ TIG

The triangles composed of four components are:

- Δ AMO; Δ AMC; Δ CAG;
- Δ CGE; Δ MKI; Δ GIK;

Other triangles are : Δ SPI; Δ DQK

Total number of triangles

$$18 + 14 + 6 + 2 = 40$$

78. (b) All the components of questions figure are present in Answer Figure (b).

79. (d)

80. (b) Interchange fig 3 and 4. Two triangles are shown separately in fig. 1 : then open up as in fig. 2 overlap in fig. 4, then open up as in fig. 3, then one triangle flips to give the position shown in fig. 5.

81. (a) 82. (b) 83. (d) 84. (d) 85. (d)

86. (d) Selecting the candidate of election is the function of the political party

87. (b) Lal Bahadur Shastri was the second Prime Minister of the Republic of India and a leader of the Indian National Congress party. Shastri joined the Indian independence movement in the 1920s.

88. (c) The Joint Session of Parliament resolves the deadlock between Lok Sabha and Rajya Sabha over an ordinary bill.
89. (b) The law explains that wind is deflected to the right in the Northern Hemisphere and to the left in the Southern Hemisphere, derived from the application of the Coriolis effect to air masses.
90. (b) The currency of Iran is Rial.
91. (b) 92. (c) 93. (d) 94. (c)
95. (b) 1191 - First Battle of Tarain in which Prithviraj Chauhan defeated Mohd. Ghori. 1192 - Second Battle of Tarain in which Mohd. Ghori defeated Prithviraj Chauhan.
96. (c) The first major attempt in curriculum reconstruction in India was made in 1937 when Gandhiji propounded the idea of Basic Education.
97. (b) Simon Commission (1927) > Dandi March (1930) > Gandhi Irwin Pact (1931) > Poona Pact (1932)
98. (d) 99. (a) 100. (d) 101. (b)
102. (b) 103. (c) 104. (a) 105. (b)
106. (a) 107. (c) 108. (b)
109. (d) The Dandi March of Gandhi was an important part of the Indian Independence Movement. It was a direct action campaign of tax resistance and non-violent protest against British salt monopoly and triggered the wider Civil Disobedience Movement.
110. (d) A presidential system is a republican system of government where a head of government is also head of state and leads an executive branch that is separate from the legislative branch. The United States, for instance, has a presidential system. Popular election of President, no overlap in membership and fixed term of office are the main criteria of Presidential form of Government.
111. (d) Aihole inscription is found at Aihole in Karnataka state India, was written by the Ravikirti, court poet of Chalukya king, Pulakeshin II who reigned from 610 to 642 CE. The poetic verses of Ravikirti, in praise of the king, can be read in the Meguti temple, dated 634 CE.
112. (a) Kalahari desert is present in Africa while Atacama Desert is in South America. Thar Desert is in Australia and Great Victoria is in Australia.
113. (d) Jammu and Kashmir
114. (a) Mumbai (V.T)
115. (c) 1950
116. (d) Mahatma Gandhi
117. (d) PMSMA
118. (b) Narendra Modi
119. (a) China
120. (d) Maharashtra